



## Electronic Energy Meter (Smart Meter)



The global demand for energy is insatiable. As energy demands increase, it is ever more important that consumption is monitored and regulated on a real-time basis. Smart metering makes possible the coordination of energy production and demand, the immediate reporting of disruptions, and provides the consumer a tool to manage individual consumption. Central Semiconductor manufactures discrete devices critical to the efficient and reliable operation of smart meters. Central's discrete semiconductors are used in all functions of smart meter topologies.

For more information visit: [www.centrasemi.com/product/smartmeter](http://www.centrasemi.com/product/smartmeter)

### Electronic Energy Meter (Smart Meter) Topology

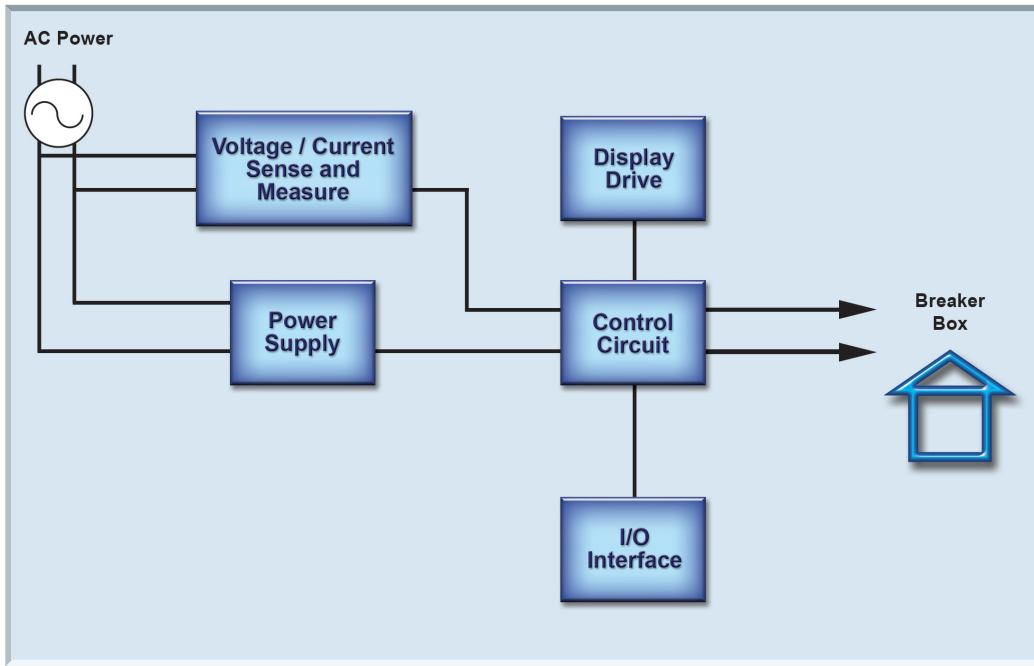

#### Voltage/Current Sense and Measure

##### • Bridge Rectifiers (Full Wave)

- CBR1-D040S: 400V, 1.0A (SMDIP)
- CBR1-D060S: 600V, 1.0A (SMDIP)
- CBR2-D040S: 400V, 2.0A (SMDIP)
- CBR2-D060S: 600V, 2.0A (SMDIP)

##### • Bi-Directional Transient Voltage Suppressors (Specified by Stand-Off Voltage)

- 1SMB170CA: 600W, 170V (SMB)
- P6SMB200CA: 600W, 171V (SMB)
- 1SMC170CA: 1.5kW, 170V (SMC)
- 1.5SMC200CA: 1.5kW, 171V (SMC)
- 3SMC170CA: 3.0kW, 170V (SMC)

##### • Schottky Diodes

- CMLSH05-4: 40V, 500mA (SOT-563)
- CMKSH-3T: 30V, 100mA, Triple Isolated (SOT-363)

##### • Zener Diodes

- CMOZ3V3 thru CMOZ15V: 350mW, 3.3V -15V (SOD-523)
- CMHZ5226B thru CMHZ5245B: 500mW, 3.3V to 15V (SOD-123)

##### • Small Signal Diodes

- CMOD2005: 350V, 250mA (SOD-523)
- CMXD2004: 300V, 225mA Triple Isolated (SOT-26)

##### • Current Limiting Diodes

- CMJH100: 10mA, 3.5V (SOD-123FL)
- CMJH150: 15mA, 4.3V (SOD-123FL)

For more information visit: [www.centrasemi.com/apps/vcsm8](http://www.centrasemi.com/apps/vcsm8) weblink scan

Use QR reader for direct link to application web page.







## Display Drive

### • MOSFETs



- 
 [CMPDPM203NH: 20V, 3.2A N-Channel (SOT-23F)  
 CMPDPM302PH: 30V, 2.4A P-Channel (SOT-23F)
- 
 -CMLDM7005: 20V, 650mA Dual, N-Channel (SOT-563)

### • Small Signal Transistors



- 
 [CMUT3904: 0.2A, 40V NPN (SOT-523)  
 CMUT3906: 0.2A, 40V PNP (SOT-523)

### • Schottky Diodes





- 
 -CMKSH-3T: 30V, 100mA Triple, Isolated (SOT-363)

For more information visit: [www.centrasemi.com/apps/dd8](http://www.centrasemi.com/apps/dd8)

## Power Supply

### • Bridge Rectifiers (Full Wave)



- 
 [CBR1-D060S: 600V, 1.0A (SMDIP)  
 CBR2-D060S: 600V, 2.0A (SMDIP)
- 
 -CBR4M-L040: 400V, 4.0A (Case DM)



### • Bi-Directional Transient Voltage Suppressors (Specified by Stand-Off Voltage)



- 
 [1SMC170CA: 1.5kW, 170V (SMC)  
 3SMC170CA: 3.0kW, 170V (SMC)

### • Schottky Rectifiers



- 
 -CMSH3-60M: 60V, 3.0A (SMB)
- 
 -CMSH5-60: 60V, 5.0A (SMC)

### • Ultrafast Rectifiers



- 
 [CMR2U-06: 600V, 2.0A, 100ns (SMB)  
 CMR3U-06M: 600V, 3.0A, 100ns (SMB)

### • MOSFETs



- 
 [CMPDPM203NH: 20V, 3.2A N-Channel (SOT-23F)  
 CMPDPM302PH: 30V, 2.4A P-Channel (SOT-23F)

For more information visit: [www.centrasemi.com/apps/ps8](http://www.centrasemi.com/apps/ps8)

## Control Circuit

### • Current Limiting Diodes



- 
 [CMJH100: 10mA, 3.5V (SOD-123FL)  
 CMJH150: 15mA, 4.3V (SOD-123FL)

### • Zener Diodes



- 
 -CMHZ5226B thru  
 CMHZ5245B: 500mW, 3.3V to 15V (SOD-123)



### • MOSFETs



- 
 [CMUDM7005: 20V, 0.65A N-Channel (SOT-523)  
 CMUDM8005: 20V, 0.65A P-Channel (SOT-523)

### • Small Signal Transistors



- 
 -CZT2222A: 0.6A, 40V NPN (SOT-223)
- 
 [CMUT3904: 0.2A, 40V NPN (SOT-523)  
 CMUT3906: 0.2A, 40V PNP (SOT-523)

For more information visit: [www.centrasemi.com/apps/cc8](http://www.centrasemi.com/apps/cc8)

## I/O Interface

### • ESD Transient Voltage Suppressors





- 
 [CSL05: 400W, 5.0V, Ultra Low Capacitance (SOT-23)  
 CSL05D: 400W, 5.0V, Dual, Ultra Low Capacitance (SOT-23)  
 CMPLC1V5D: 50W, 1.5V, Dual Ultra Low Capacitance (SOT-23)

- 
 -CMNTVS12V: 18W, 12V Quad, Low Capacitance (SOT-953)

- 
 -CTLTVS12: 35W, 12V Low Capacitance (TLM2D3D6)

### • Schottky Diodes



- 
 -CMASH-4: 200mA, 40V (SOD-923)
- 
 -CMRSH-4DO: 200mA, 40V Dual, Opposing (SOT-963)

### • Small Signal Diodes



- 
 -CMXD2004: 300V, 225mA Triple Isolated (SOT-26)

For more information visit: [www.centrasemi.com/apps/loi8](http://www.centrasemi.com/apps/loi8)

## Samples

To order samples of these devices visit:  
<http://web.centrasemi.com/search/sample.php>

## Literature

Order your selection guide today.  
Visit: [web.centrasemi.com/search/sample.php](http://web.centrasemi.com/search/sample.php)



**Innovative Discrete Semiconductors**

For further information contact:  
Sales at Central Semiconductor Corp.  
(631) 435-1110 or visit:  
[www.centrasemi.com](http://www.centrasemi.com)