

ACPDUC5V0C-HF

RoHS Device
Halogen Free



Features

- Bi-directional ESD protection.
- IEC61000-4-2 Level 4 ESD protection.
- Surface mount package.
- Ultra small SMD package.
- Comply with AEC-Q101

Mechanical data

- Case: 0603C/SOD-523F standard package, molded plastic.
- Terminals: Matte tin plated, solderable per MIL-STD-750, method 2026.
- Mounting position: Any.
- Weight: 0.003 grams(approx.).

Circuit diagram

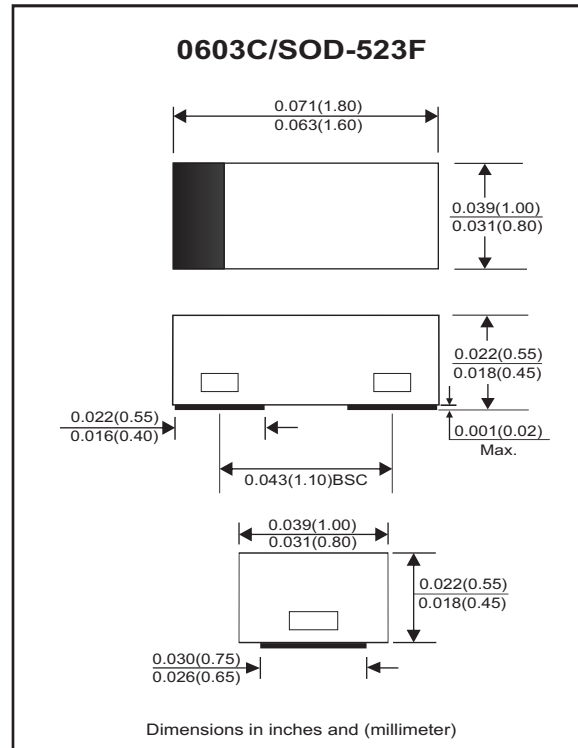

Maximum Rating (at TA=25°C unless otherwise noted)

Parameter	Conditions	Symbol	Value	Unit
Peak pulse power	T _P = 8/20us	P _{PP}	68	W
Peak pulse current	T _P = 8/20us	I _{PP}	4	A
ESD capability	IEC 61000-4-2(air) IEC 61000-4-2(contact)	ESD	±15 ±8	kV
Operation temperature range		T _J	-55~+125	°C
Storage temperature range		T _{STG}	-55~+150	°C

Electrical Characteristics (at TA=25°C unless otherwise noted)

Parameter	Conditions	Symbol	Min	Typ	Max	Unit
Working peak reverse voltage		V _{RWM}			5	V
Breakdown voltage	I _T = 1mA	V _{BR}	6.1	7.0		V
Reverse leakage current	V _{RWM} = 5V	I _R		0.1	2.0	uA
Clamping voltage	I _{PP} = 1A, T _P = 8/20us I _{PP} = 4A, T _P = 8/20us	V _C			10 17	V
Junction capacitance	V _R = 0V, f = 1MHz	C _J		25	30	pF

RATING AND CHARACTERISTIC CURVES (ACPDUC5V0C-HF)

Fig.1 - 8/20us Peak Pulse Current Waveform Acc. IEC 61000-4-5

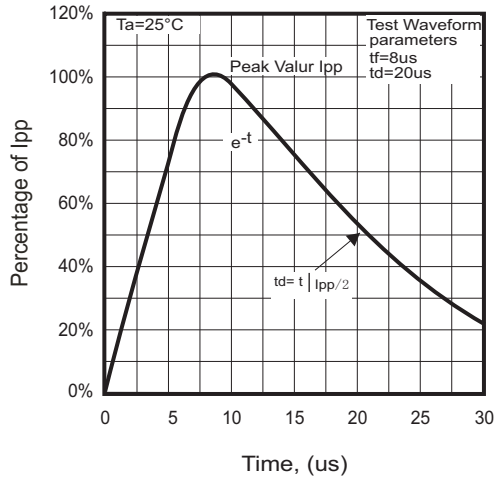

Fig.2 - Typical Capacitance Between Terminals Characteristics

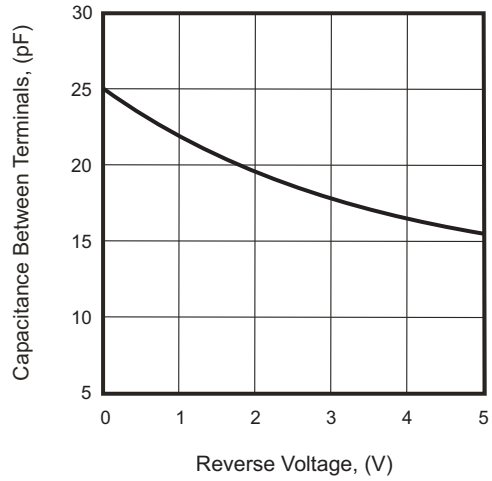

Fig.3 - Clamping Voltage Vs. Peak Pulse Current

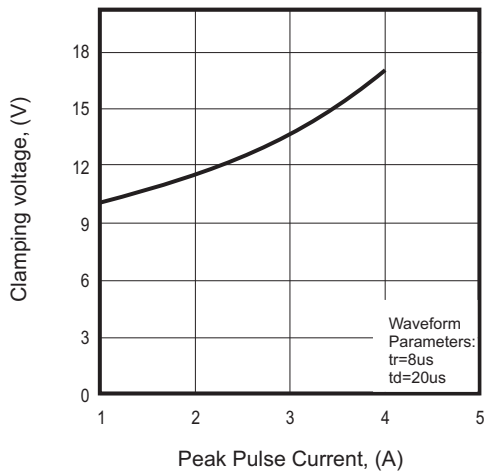
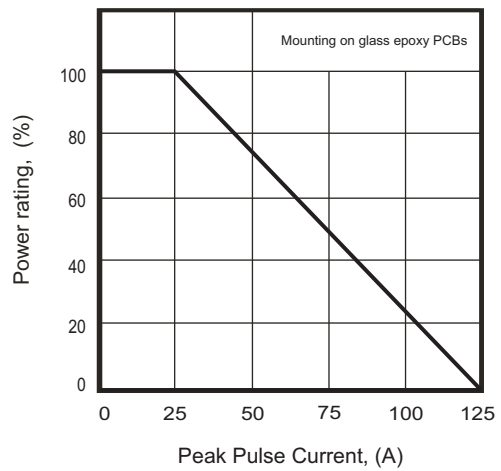
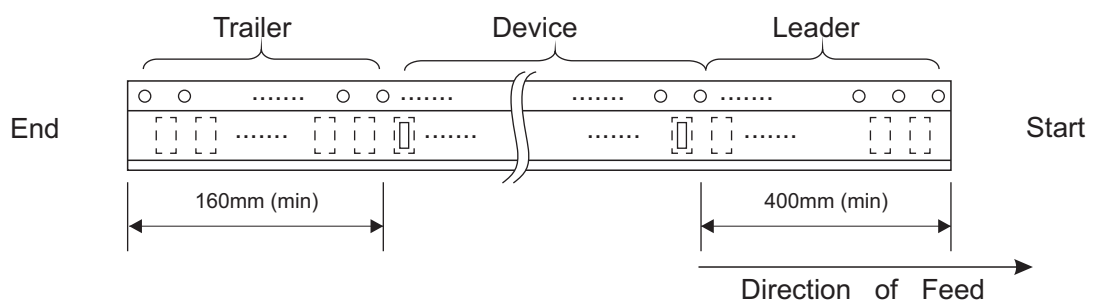
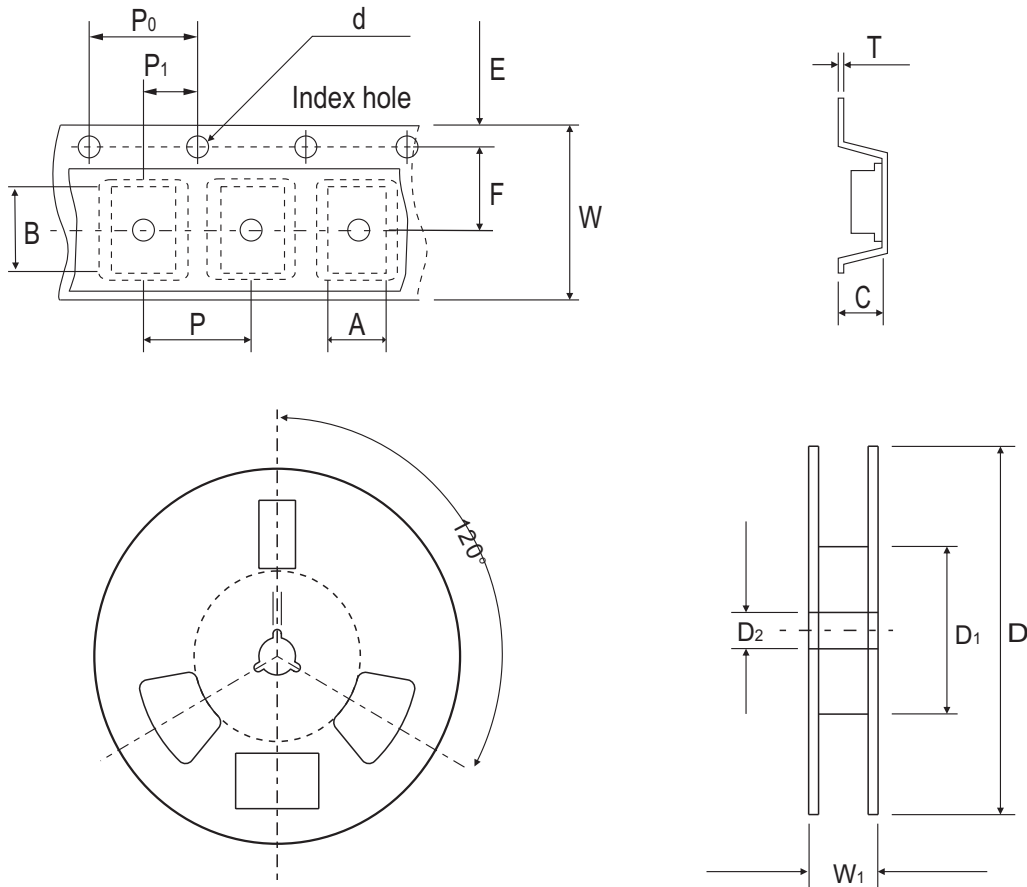

Fig.4 - Power Rating Derating Curve



Reel Taping Specification



0603C/ SOD-523F	SYMBOL	A	B	C	d	D	D ₁	D ₂
	(mm)	1.05 ± 0.05	1.96 ± 0.05	0.57 ± 0.05	1.50 + 0.10 - 0	178.00 ± 1.00	60.00 ± 0.50	13.50 ± 0.20
	(inch)	0.041 ± 0.002	0.077 ± 0.002	0.022 ± 0.002	0.059 + 0.004 - 0	7.008 ± 0.039	2.362 ± 0.020	0.531 ± 0.008

0603C/ SOD-523F	SYMBOL	E	F	P	P ₀	P ₁	T	W	W ₁
	(mm)	1.75 ± 0.10	3.50 ± 0.05	4.00 ± 0.10	4.00 ± 0.05	2.00 ± 0.05	0.20 ± 0.03	8.00 ± 0.20	12.00 + 0.50 - 0
	(inch)	0.069 ± 0.004	0.138 ± 0.002	0.157 ± 0.004	0.157 ± 0.002	0.079 ± 0.002	0.008 ± 0.001	0.315 ± 0.008	0.472 + 0.020 - 0

Marking Code

Part Number	Marking Code
ACPDUC5V0C-HF	E05



Suggested PAD Layout

SIZE	0603C/SOD-523F	
	(mm)	(inch)
A	1.10	0.043
B	0.70	0.028
C	1.00	0.039
D	1.80	0.071
E	0.40	0.016

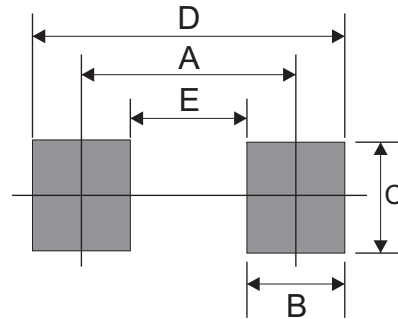

Standard Packaging

Case Type	REEL PACK	
	REEL (pcs)	Reel Size (inch)
0603C/SOD-523F	4,000	7