

BC817-16-HF/25-HF/40-HF (NPN)

RoHS Device

Halogen Free

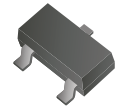

Features

- For general AF applications.
- High collector current.
- High current gain.
- Low collector-emitter saturation voltage.

Mechanical data

- Case: SOT-23, molded plastic.
- Terminals: Solderable per MIL-STD-750, method 2026.
- Weight: 0.0078 grams(approx.).

Diagram:

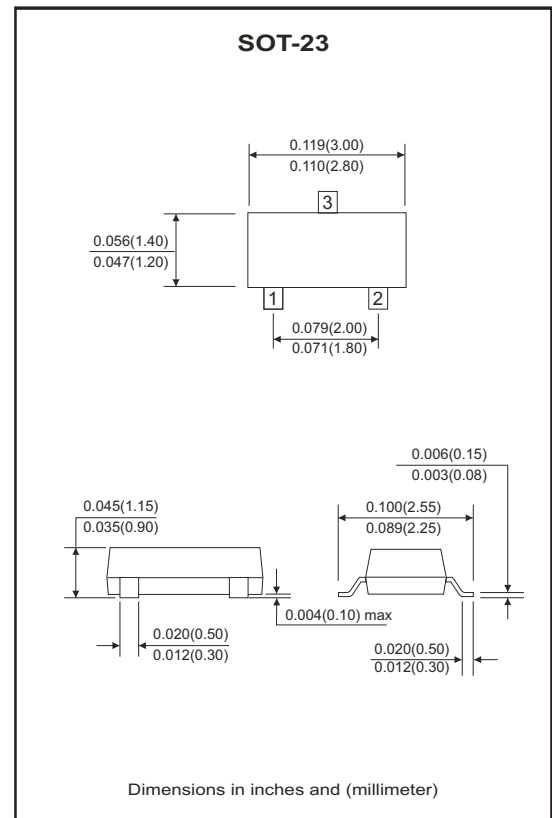
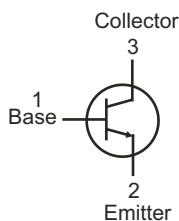

Maximum Ratings (at $T_A=25^{\circ}\text{C}$ unless otherwise noted)

Parameter	Symbol	Value	Unit
Collector-Base voltage	V_{CB0}	50	V
Collector-Emitter voltage	V_{CE0}	45	V
Emitter-Base voltage	V_{EB0}	5	V
Collector current-continuous	I_c	500	mA
Collector power dissipation	P_c	300	mW
Thermal resistance from junction to ambient	$R_{\theta JA}$	417	$^{\circ}\text{C}/\text{W}$
Junction atemperature range	T_J	150	$^{\circ}\text{C}$
Storage temperature range	T_{STG}	-55 to +150	$^{\circ}\text{C}$

Electrical Characteristics (at $T_A=25^\circ\text{C}$ unless otherwise noted)

Parameter	Symbol	Conditions	Min	Typ	Max	Unit
Collector-Base breakdown voltage	$V_{(BR)CBO}$	$I_C = 10\mu\text{A}, I_E = 0$	50			V
Collector-Emitter breakdown voltage	$V_{(BR)CEO}$	$I_C = 10\text{mA}, I_B = 0$	45			V
Emitter-Base breakdown voltage	$V_{(BR)EBO}$	$I_E = 1\mu\text{A}, I_C = 0$	5			V
Collector cut-off current	I_{CBO}	$V_{CB} = 45\text{V}, I_E = 0$			0.1	μA
Emitter cut-off current	I_{EBO}	$V_{EB} = 4\text{V}, I_C = 0$			0.1	μA
DC current gain	$h_{FE(1)}$	$V_{CE} = 1\text{V}, I_C = 100\text{mA}$	100		600	
	$h_{FE(2)}$	$V_{CE} = 1\text{V}, I_C = 500\text{mA}$	40			
Collector-Emitter saturation voltage	$V_{CE(SAT)}$	$I_C = 500\text{mA}, I_B = 50\text{mA}$			0.7	V
Base-Emitter saturation voltage	$V_{BE(SAT)}$	$I_C = 500\text{mA}, I_B = 50\text{mA}$			1.2	V
Base-Emitter voltage	$V_{BE(ON)}$	$V_{CE} = 1\text{V}, I_C = 500\text{mA}$			1.2	V
Collector capacitance	C_{ob}	$V_{CB} = 10\text{V}, f = 10\text{MHz}$		10		pF
Transition frequency	f_T	$V_{CE} = 5\text{V}, I_C = 10\text{mA}, f = 100\text{MHz}$	100			MHz

Classification of $h_{FE(1)}$

Rank	BC817-16-HF	BC817-25-HF	BC817-40-HF
Range	100-250	160-400	250-600

RATING AND CHARACTERISTIC CURVES (BC817-16-HF/25-HF/40-HF)

Fig.1 - Static Characteristic

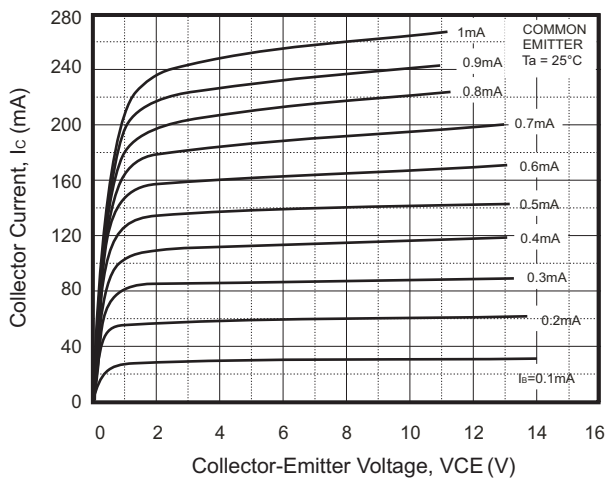
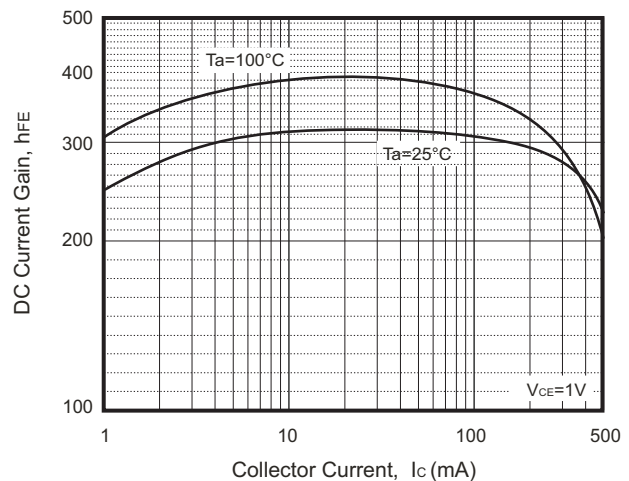

Fig.2 - $h_{FE} - I_C$



RATING AND CHARACTERISTIC CURVES (BC817-16-G/25-G/40-G)

Fig.3 - $V_{BEsat} - I_C$

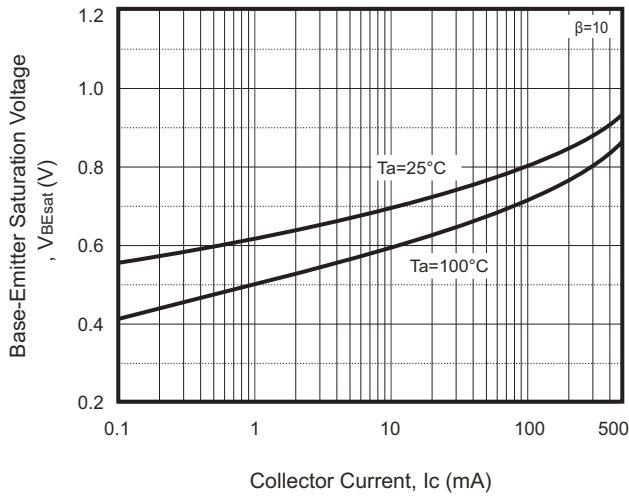

Fig.4 - $V_{CEsat} - I_C$

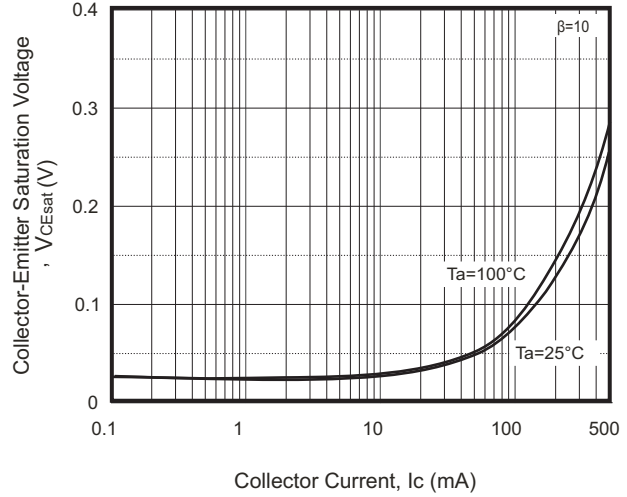

Fig.5 - $I_C - V_{BE}$

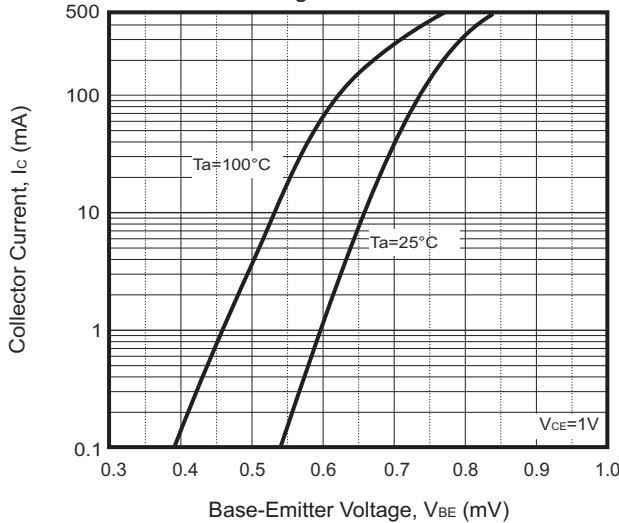

Fig.6 - $C_{ob}/C_{ib} - V_{CB}/V_{EB}$

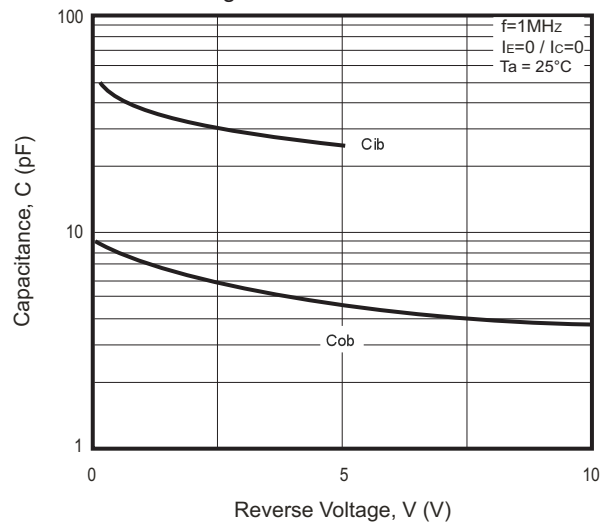

Fig.7 - $f_T - I_C$

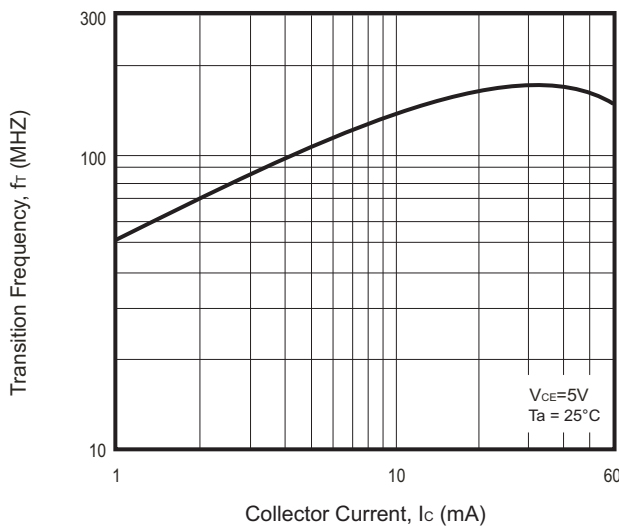
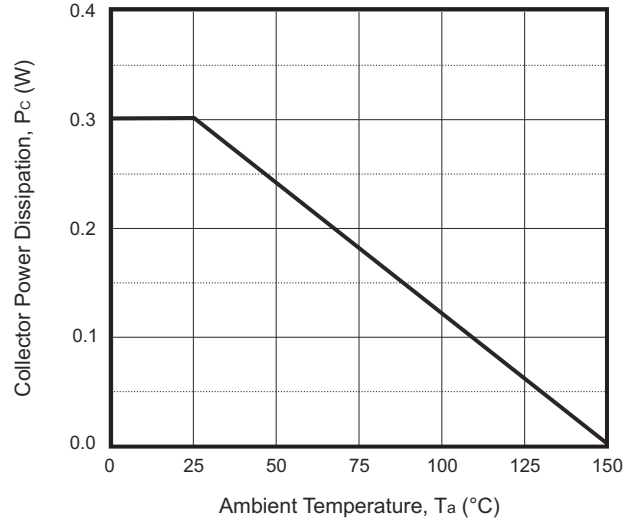
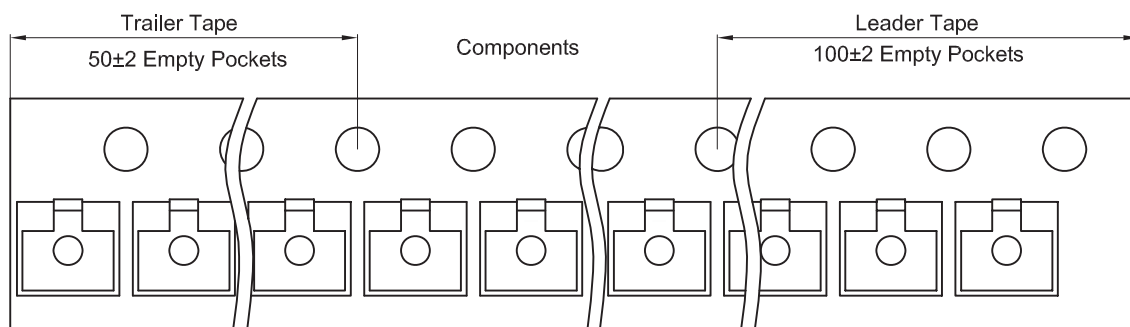
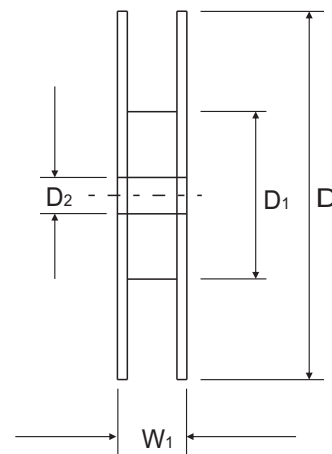
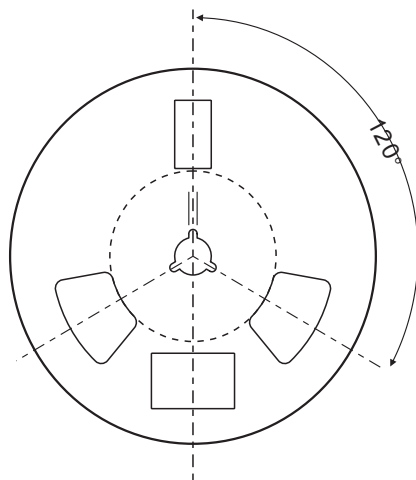
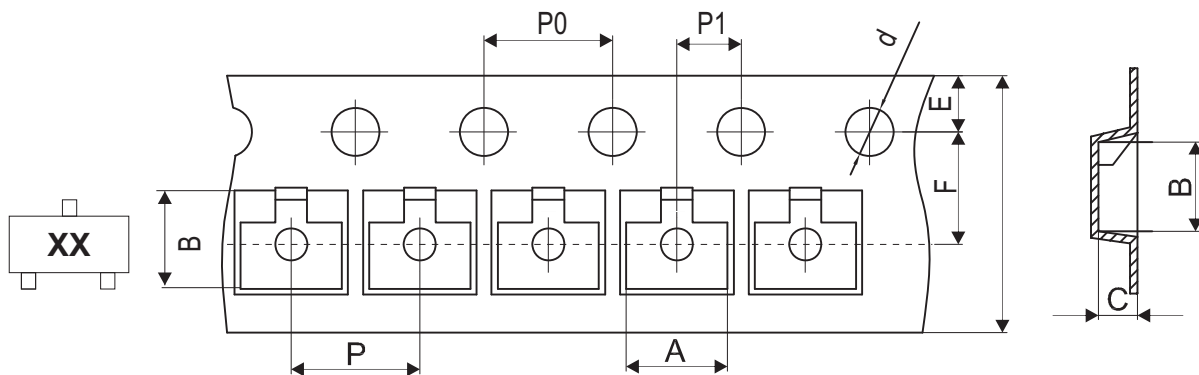

Fig.8 - $P_c - T_a$



Reel Taping Specification



SOT-23	SYMBOL	A	B	C	d	D	D1	D2
	(mm)	3.15 ± 0.10	2.77 ± 0.10	1.22 ± 0.10	1.50 ± 0.10	178.00 ± 2.00	54.40 ± 1.00	13.00 ± 1.00
	(inch)	0.124 ± 0.004	0.109 ± 0.004	0.048 ± 0.004	0.059 ± 0.004	7.008 ± 0.079	2.142 ± 0.039	0.512 ± 0.039

SOT-23	SYMBOL	E	F	P	P0	P1	W	W1
	(mm)	1.75 ± 0.10	3.50 ± 0.10	4.00 ± 0.10	4.00 ± 0.10	2.00 ± 0.10	8.00 + 0.30 / - 0.10	12.30 ± 1.00
	(inch)	0.069 ± 0.004	0.138 ± 0.004	0.157 ± 0.004	0.157 ± 0.004	0.079 ± 0.004	0.315 + 0.012 / - 0.004	0.484 ± 0.039

Marking Code

Part Number	Marking Code
BC817-16-HF	6A
BC817-25-HF	6B
BC817-40-HF	6C

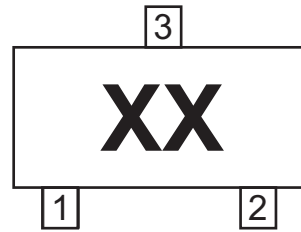

xx = Product type marking code

Suggested PAD Layout

SIZE	SOT-23	
	(mm)	(inch)
A	0.80	0.031
B	0.60	0.024
C	1.90	0.075
D	2.02	0.080
E	2.82	0.111

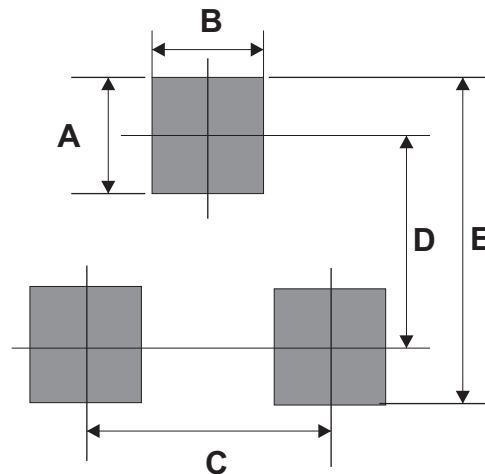

Standard Packaging

Case Type	Qty Per Reel	Reel Size
	(Pcs)	(inch)
SOT-23	3,000	7