

CDBT-40/S/C/A-HF

Reverse Voltage: 40 Volts

Forward Current: 200 mA

RoHS Device

Halogen Free

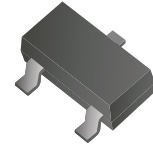

Features

- Design for mounting on small surface.
- High speed switching application, circuit protection.
- Low forward voltage drop.

Mechanical data

- Case: SOT-23, molded plastic.
- Terminals: Solderable per MIL-STD-750, method 2026.
- Weight: 0.0078 grams(approx.).

Circuit diagram



CDBT-40-HF Marking Code: 43
 CDBT-40S-HF Marking Code: 44
 CDBT-40C-HF Marking Code: 45
 CDBT-40A-HF Marking Code: 46

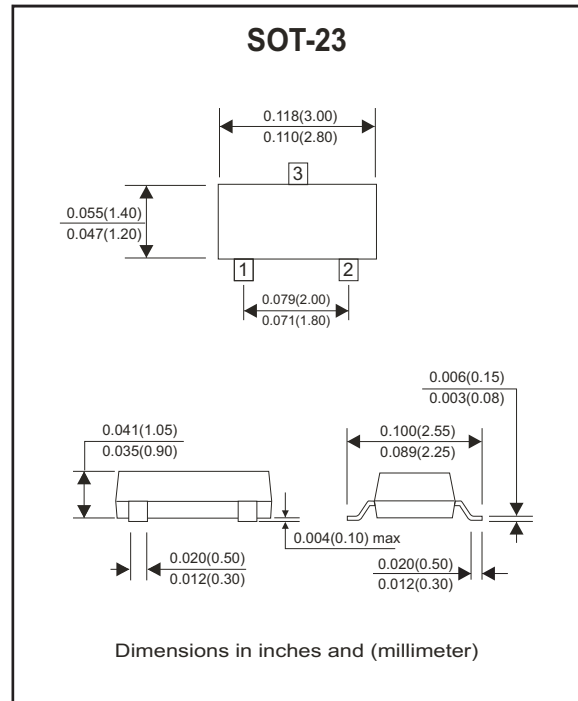

Maximum Ratings (at Ta=25°C unless otherwise noted)

Parameter	Symbol	Conditions	Value	Unit
Peak repetitive peak reverse voltage	V_{RRM}		40	V
Working peak reverse voltage	V_{RWM}			
DC blocking voltage	V_R			
Forward continuous current	I_F		200	mA
Power dissipation	P_D		200	mW
Thermal resistance	$R_{\theta JA}$	Junction to ambient	500	°C/W
Junction temperature	T_J		125	°C
Storage temperature range	T_{STG}		-55 to +150	°C

Electrical Characteristics (at Ta=25°C unless otherwise noted)

Parameter	Symbol	Conditions	Min.	Max.	Unit
Reverse breakdown voltage	V_{BR}	$I_R=10\mu A$	40		V
Reverse voltage leakage current	I_R	$V_R=30V$		200	nA
Forward voltage	V_F	$I_F=1mA$		380	mV
		$I_F=40mA$		1000	
Diode capacitance	C_D	$V_R=0V, f=1MHz$		5	pF
Reverse recovery time	T_{rr}	$I_{rr}=1mA, I_F=I_R=10mA, R_L=100\Omega$		5	nS

RATING AND CHARACTERISTIC CURVES (CDBT-40/S/C/A-HF)

Fig.1 - Forward Characteristics

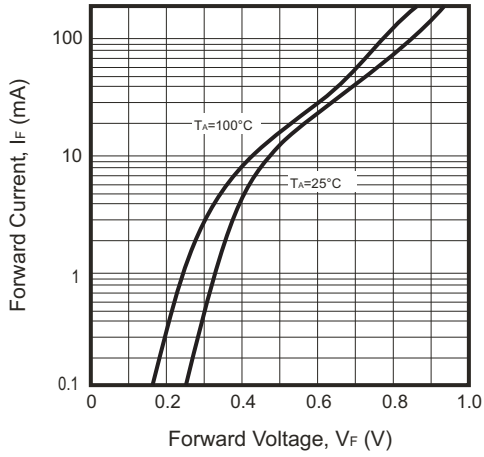

Fig.2 - Reverse Characteristics

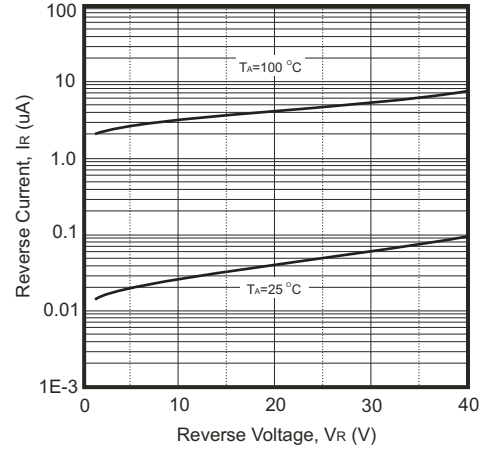

Fig.3 - Capacitance Characteristics

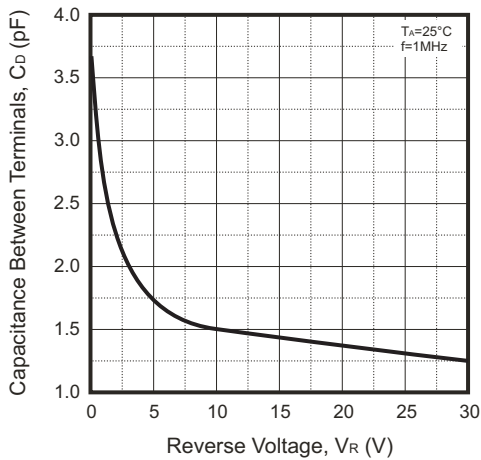
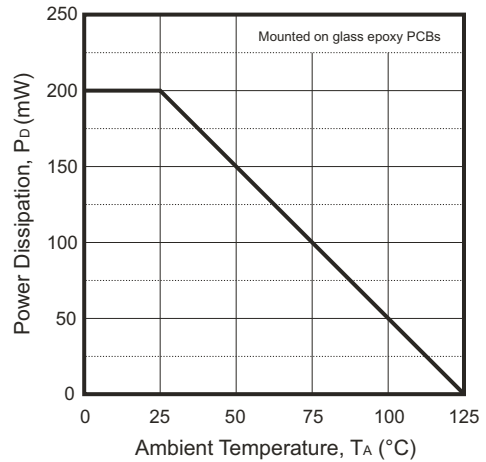
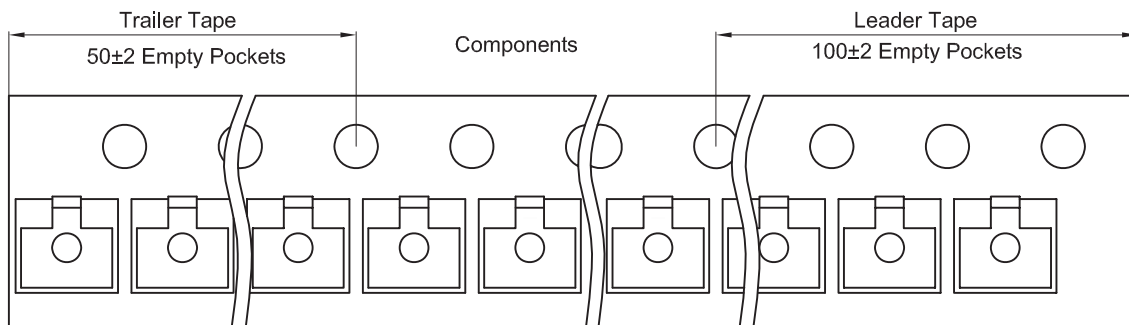
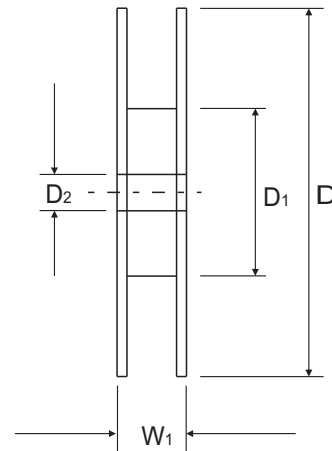
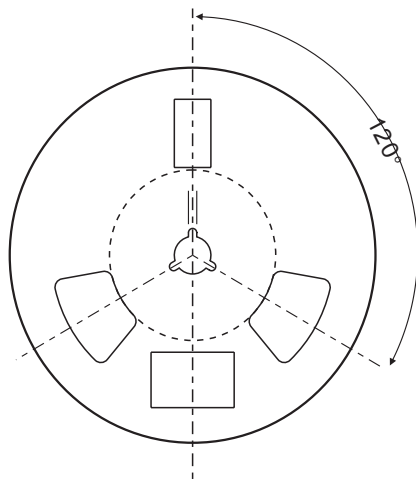
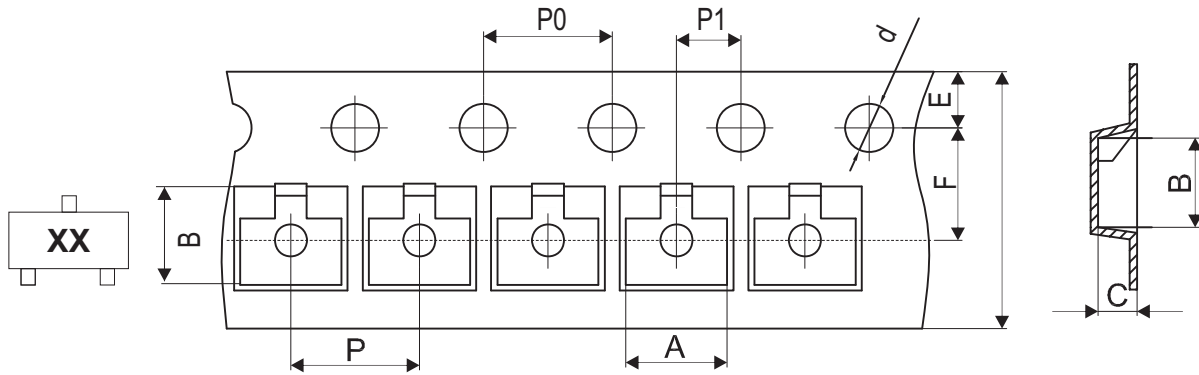

Fig.4 - Power Derating Curve



Reel Taping Specification



SOT-23	SYMBOL	A	B	C	d	D	D1	D2
	(mm)	3.15 ± 0.10	2.77 ± 0.10	1.22 ± 0.10	1.50 ± 0.10	178.00 ± 2.00	54.40 ± 1.00	13.00 ± 1.00
	(inch)	0.124 ± 0.004	0.109 ± 0.004	0.048 ± 0.004	0.059 ± 0.004	7.008 ± 0.079	2.142 ± 0.039	0.512 ± 0.039

SOT-23	SYMBOL	E	F	P	P0	P1	W	W1
	(mm)	1.75 ± 0.10	3.50 ± 0.10	4.00 ± 0.10	4.00 ± 0.10	2.00 ± 0.10	8.00 + 0.30 / - 0.10	12.30 ± 1.00
	(inch)	0.069 ± 0.004	0.138 ± 0.004	0.157 ± 0.004	0.157 ± 0.004	0.079 ± 0.004	0.315 + 0.012 / - 0.004	0.484 ± 0.039

Marking Code

Part Number	Marking Code
CDBT-40-HF	43
CDBT-40S-HF	44
CDBT-40C-HF	45
CDBT-40A-HF	46

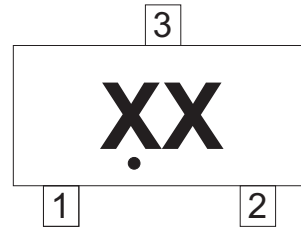

XX / XX = Product type marking code

Suggested PAD Layout

SIZE	SOT-23	
	(mm)	(inch)
A	0.80	0.031
B	0.60	0.024
C	1.90	0.075
D	2.02	0.080
E	2.82	0.111

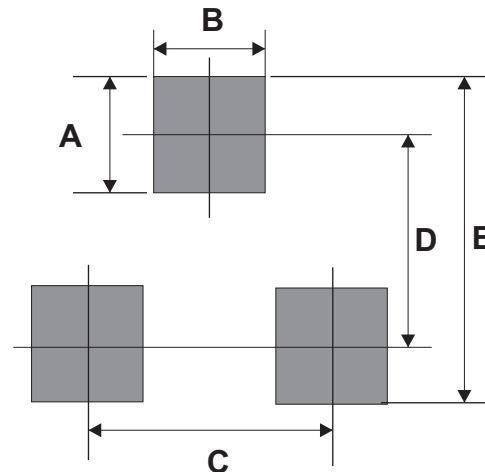

Standard Packaging

Case Type	Qty Per Reel	Reel Size
	(Pcs)	(inch)
SOT-23	3,000	7