

## CDBZ2240LL-HF

**Reverse Voltage: 40 Volts**  
**Forward Current: 2.0 Amp**  
**RoHS Device**  
**Halogen free**



### Features

- Lead less chip form, no lead damage.
- Low power loss, High efficiency.
- High current capability, low VF.
- Low forward voltage drop.
- Plastic package has UL 94V-0.

### Mechanical data

- Case: Packed with FRP substrate and epoxy underfilled.
- Terminals: Pure Tin plated (Lead-Free), solderable per MIL-STD-750, method 2026.
- Weight : 0.012 grams(approx.).

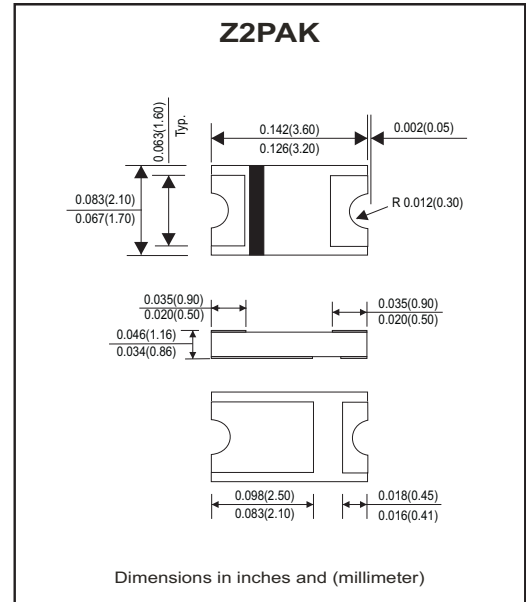

### Circuit Diagram



### Maximum Ratings (at TA=25°C unless otherwise noted)

Parameter	Symbol	Rating	Unit
Repetitive peak reverse voltage	V <sub>RRM</sub>	40	V
Average forward current	I <sub>F(AV)</sub>	2	A
Peak forward surge current (8.3ms single half sine-wave)	I <sub>FSM</sub>	40	A
Operating junction temperature range	T <sub>J</sub>	-55 to +125	°C
Storage temperature range	T <sub>STG</sub>	-55 to +150	°C

### Electrical Characteristics (at TA=25°C unless otherwise noted)

Parameter	Conditions	Symbol	Min.	Typ.	Max.	Unit
Forward voltage (NOTE 1)	@ I <sub>F</sub> = 0.5 A	V <sub>F</sub>	-	0.28	-	V
	@ I <sub>F</sub> = 1.0 A		-	0.34	-	
	@ I <sub>F</sub> = 2.0 A		-	0.39	0.40	
Repetitive peak reverse current (NOTE 1)	V <sub>R</sub> = Max. V <sub>RRM</sub> , T <sub>A</sub> = 25°C	I <sub>RRM</sub>	-	0.28	1.0	mA
Junction capacitance	V <sub>R</sub> = 4V, f = 1.0 MHz	C <sub>J</sub>	-	115	-	pF
Thermal resistance	Junction to ambient (NOTE 2)	R <sub>θJA</sub>	-	70	-	°C/W
	Junction to case (NOTE 2)	R <sub>θJC</sub>	-	22	-	°C/W

NOTES : (1) Pulse test width PW=300usec , 1% duty cycle.  
 (2) Mounted on P.C. board with 0.2 x 0.2"(5.0 x5.0mm) copper pad areas.

## RATING AND CHARACTERISTIC CURVES (CDBZ2240LL-HF)

Fig.1 - Typical Forward Current Derating Curve

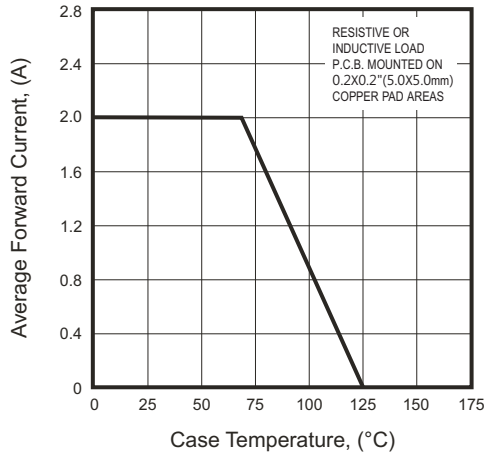

Fig.2 - Typical Forward Characteristics

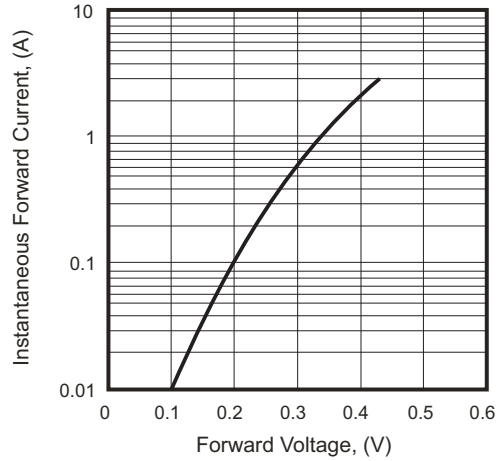

Fig.3 - Non-repetitive Forward Surge Current

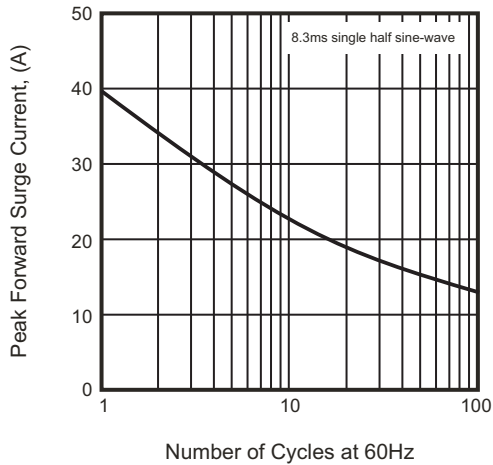

Fig.4 - Typical Reverse Characteristics

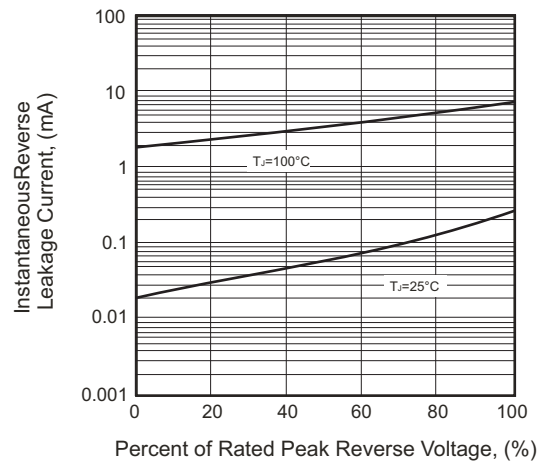
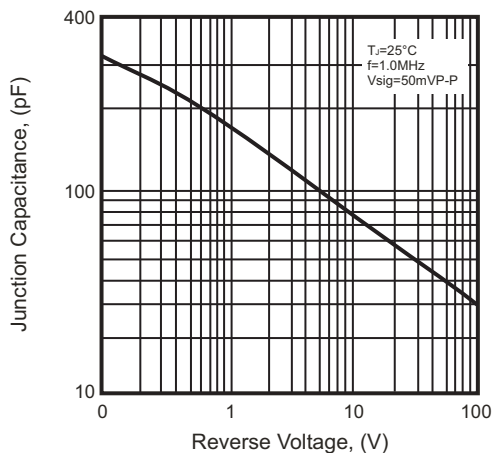
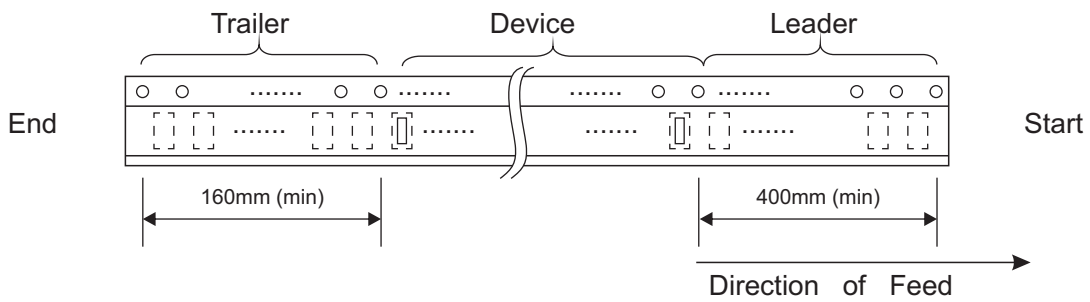
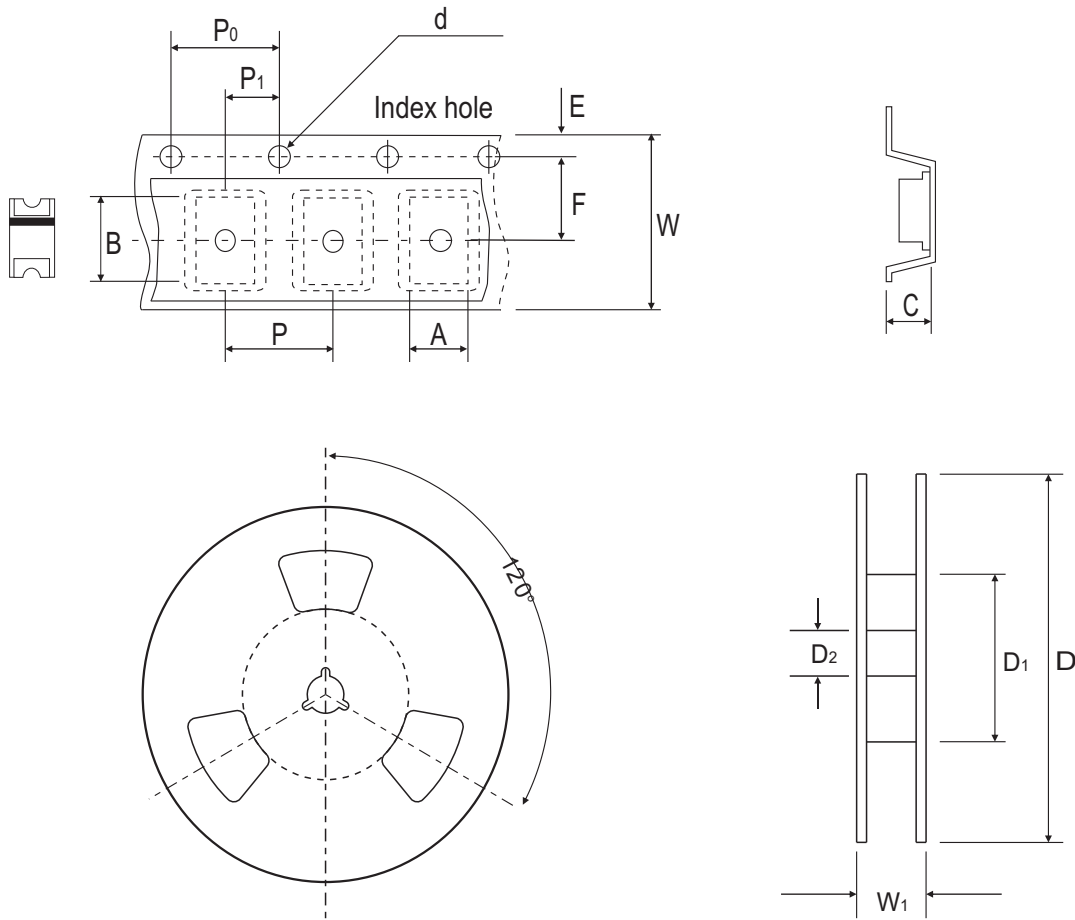

Fig.5 - Typical Junction Capacitance



## Reel Taping Specification



Z2PAK	SYMBOL	A	B	C	d	D	D <sub>1</sub>	D <sub>2</sub>
	(mm)	2.20 ± 0.10	3.65 ± 0.10	1.28 ± 0.10	1.50 ± 0.10	178.00 ± 2.00	50.00 MIN.	13.00 ± 0.50
	(inch)	0.087 ± 0.004	0.144 ± 0.004	0.050 ± 0.004	0.059 ± 0.004	7.008 ± 0.079	1.969 MIN.	0.512 ± 0.020

Z2PAK	SYMBOL	E	F	P	P <sub>0</sub>	P <sub>1</sub>	W	W <sub>1</sub>
	(mm)	1.75 ± 0.10	5.50 ± 0.05	4.00 ± 0.10	4.00 ± 0.10	2.00 ± 0.10	12.00 ± 0.30	18.70 MAX.
	(inch)	0.069 ± 0.004	0.217 ± 0.002	0.157 ± 0.004	0.157 ± 0.004	0.079 ± 0.004	0.472 ± 0.012	0.736 MAX.

## Marking Code

Part Number	Marking Code
CDBZ2240LL-HF	L4L



## Suggested PAD Layout

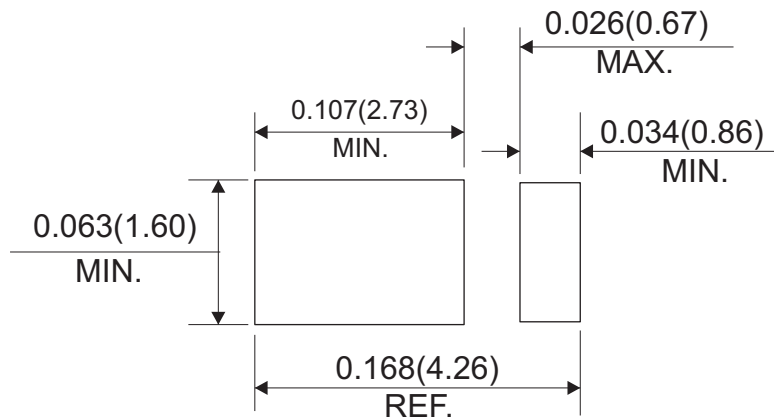

- NOTES : 1. Dimensions in inches and (millimeter)  
 2. The Layout is just for reference.

## Standard Packaging

Case Type	REEL PACK	
	REEL ( pcs )	Reel Size (inch)
Z2PAK	3,000	7