

CJ1012-G

N-Channel

RoHS Device

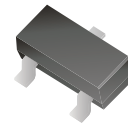

Features

- High-Side Switching.
- Low On-Resistance.
- Low Threshold.
- Fast Switching Speed.
- ESD protected up to 2KV.

Mechanical data

- Case: SOT-523, molded plastic.
- Terminals: Solderable per MIL-STD-750, method 2026.

Circuit Diagram

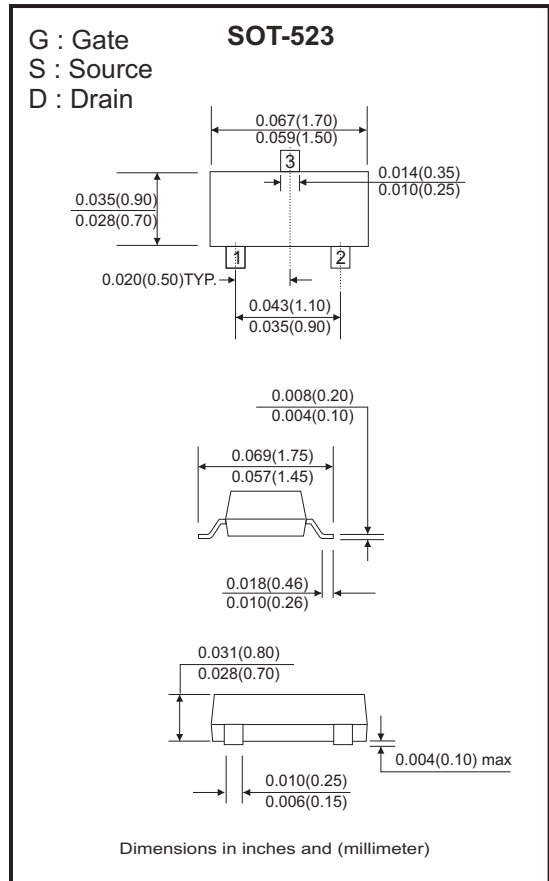
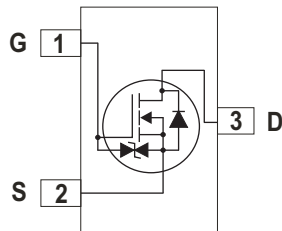

Maximum Rating (at Ta=25°C unless otherwise noted)

Parameter	Symbol	Value	Unit
Drain-source voltage	V _{DSS}	20	V
Gate-source voltage	V _{GS}	±12	V
Drain current-continuous	I _{D(DC)}	500	mA
Drain Current-pulsed (note1)	I _{DM(pulse)}	1000	mA
Power dissipation (note2, T _A =25°C)	P _D	150	mW
Max. Power dissipation (note3, T _C =25°C)		275	
Thermal resistance from junction to ambient	R _{θJA}	833	°C/W
Thermal resistance from junction to case	R _{θJC}	455	°C/W
Junction temperature	T _J	150	°C
Storage temperature	T _{STG}	-55 to +150	°C

Electrical Characteristics (at $T_A=25^{\circ}\text{C}$ unless otherwise noted)

Parameter	Symbol	Conditions	Min	Typ	Max	Units
On/Off States						
Drain-source breakdown voltage	$V_{(BR)DSS}$	$V_{GS}=0V, I_D=250\mu A$	20			V
Gate-threshold voltage	$V_{GS(th)}$	$V_{DS}=V_{GS}, I_D=250\mu A$	0.45		1.2	V
Gate-body leakage current	I_{GSS}	$V_{DS}=0V, V_{GS}=\pm 4.5V$			± 1	μA
Zero gate voltage drain current	I_{DSS}	$V_{DS}=16V, V_{GS}=0V$			100	nA
Drain-source on-state resistance	$R_{DS(on)}$	$V_{GS}=4.5V, I_D=600mA$			700	m Ω
		$V_{GS}=2.5V, I_D=500mA$			850	
Forward transconductance	g_{FS}	$V_{DS}=10V, I_D=400mA$		1		S
Dynamic Characteristics						
Input capacitance (note 4)	C_{iss}	$V_{DS}=16V, V_{GS}=0V, f=1MHz$		100		pF
Output capacitance (note 4)	C_{oss}			16		
Reverse transfer capacitance (note 4)	C_{rss}			12		
Total gate charge	Q_g	$V_{DS}=10V, V_{GS}=4.5V, I_D=250mA$		750		nC
Gate-source charge	Q_{gs}			75		
Gate-drain charge	Q_{gd}			225		
Switching Times (note 4)						
Turn-on delay time	$t_{d(on)}$	$V_{DD}=10V, I_D=200mA, R_L=47\Omega, V_{GS}=4.5V, R_G=10\Omega$		5		nS
Rise time	t_r			5		
Turn-off delay time	$t_{d(off)}$			25		
Fall time	t_f			11		
Drain-source diode characteristics						
Drain-source diode forward voltage (note 5)	V_{SD}	$I_S=0.15A, V_{GS}=0V$			1.2	V

Notes:

1. Repetitive rating: Pulse width limited by maximum junction temperature.
2. This test is performed with no heat sink at $T_a=25^{\circ}\text{C}$.
3. This test is performed with infinite heat sink at $T_c=25^{\circ}\text{C}$.
4. These parameters have no way to verify.
5. Pulse test: Pulse width $\leq 300\mu s$, Duty cycle $\leq 0.5\%$.

RATING AND CHARACTERISTIC CURVES (CJ1012-G)

Fig.1 - Output Characteristics

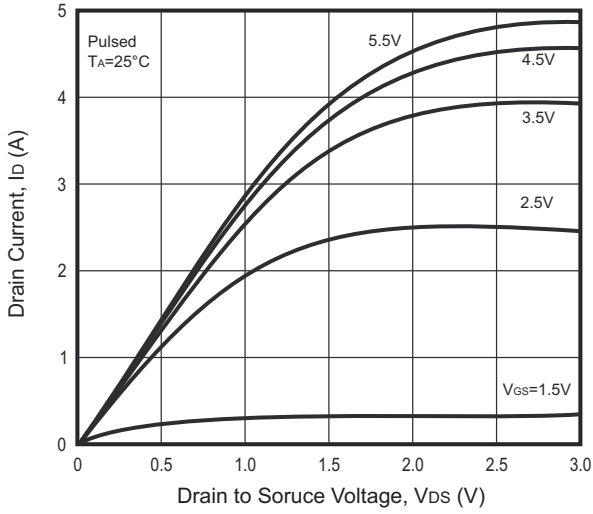

Fig.2 - Transfer Characteristics

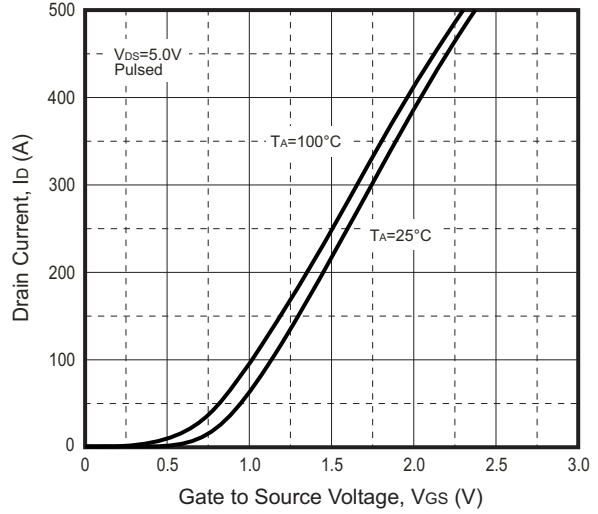

Fig.3 - $R_{DS(ON)}$ — I_D

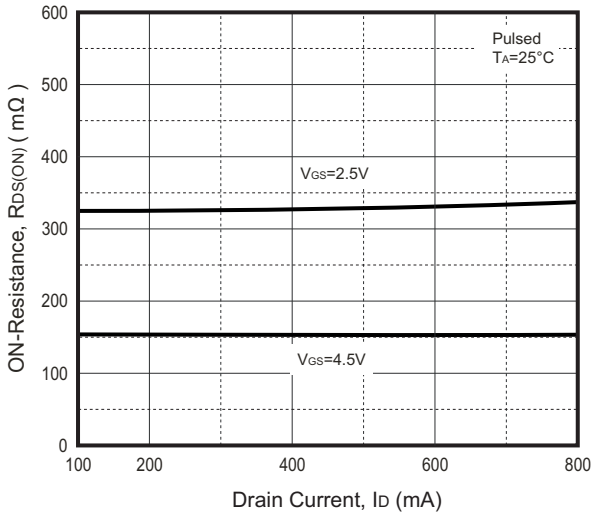

Fig.4 - $R_{DS(ON)}$ — V_{GS}

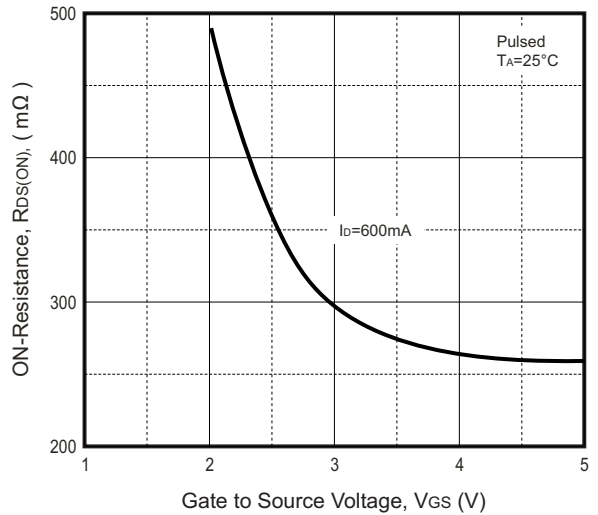

Fig.5 - I_S — V_{SD}

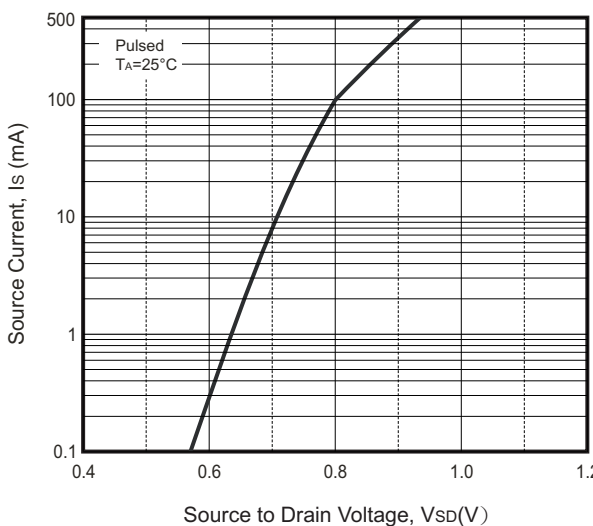
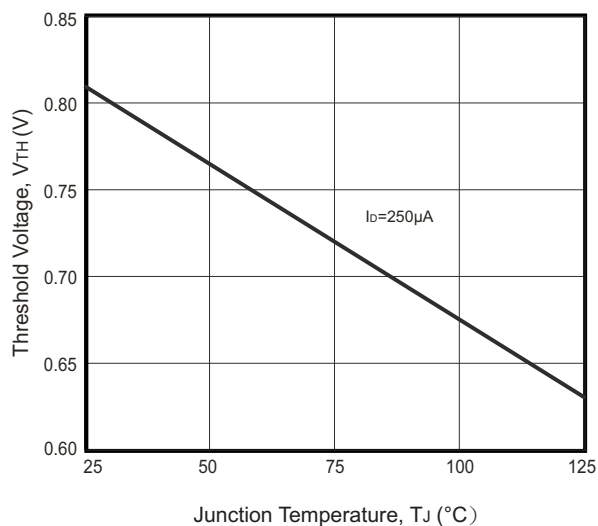
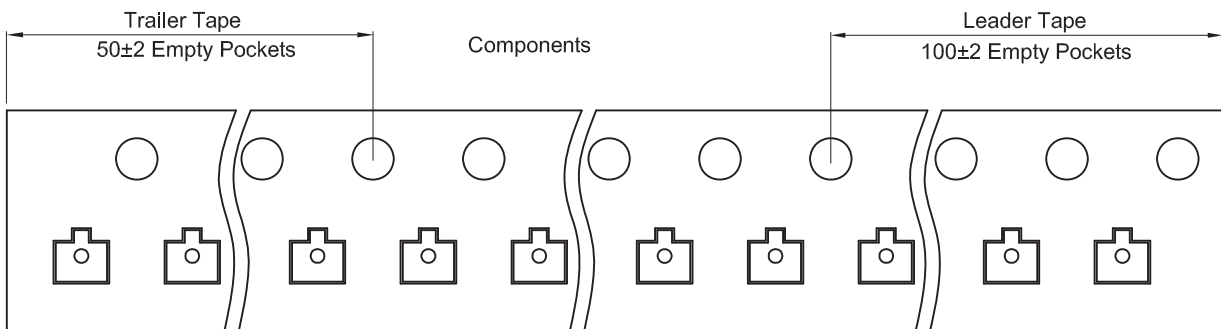
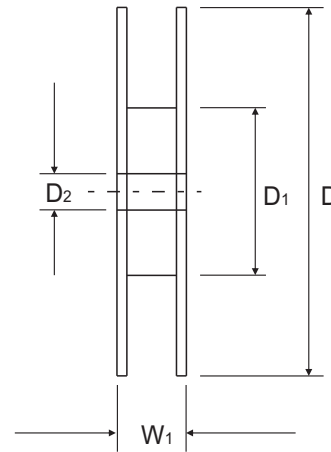
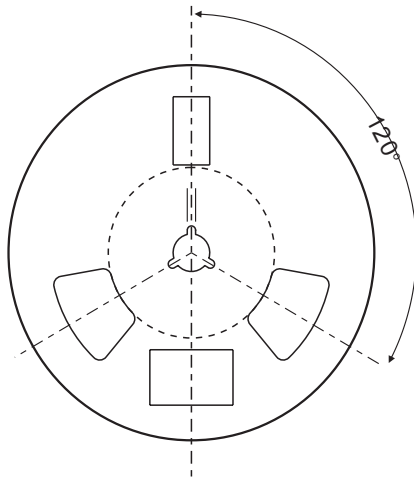
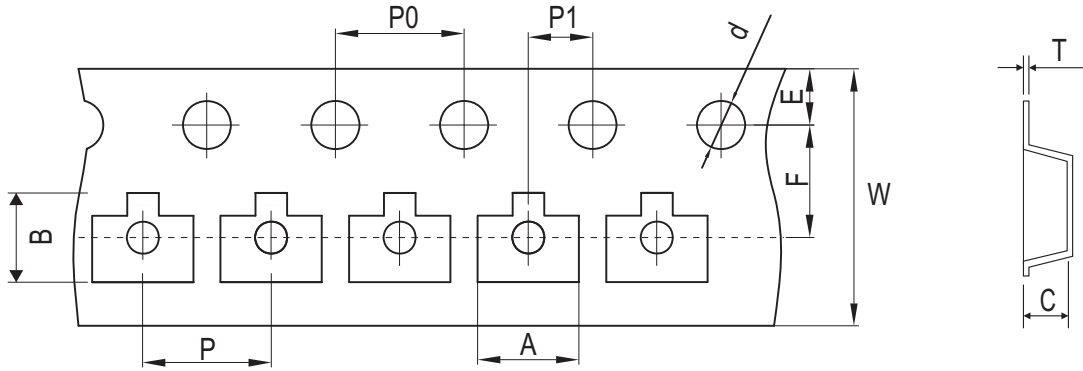

Fig.6 - Threshold Voltage



Company reserves the right to improve product design, functions and reliability without notice.

Reel Taping Specification



SOT-523	SYMBOL	A	B	C	d	D	D1	D2
	(mm)	1.85 ± 0.05	1.85 ± 0.05	0.875 ± 0.05	1.50 ± 0.10	178 ± 2.00	54.40 ± 1.00	13.00 ± 1.00
	(inch)	0.073 ± 0.002	0.073 ± 0.002	0.034 ± 0.002	0.059 ± 0.004	7.008 ± 0.079	2.142 ± 0.039	0.512 ± 0.039

SOT-523	SYMBOL	E	F	P	P0	P1	W	W1
	(mm)	1.75 ± 0.10	3.50 ± 0.10	4.00 ± 0.10	4.00 ± 0.10	2.00 ± 0.10	8.00 + 0.30 / - 0.10	12.30 ± 1.00
	(inch)	0.069 ± 0.004	0.138 ± 0.004	0.157 ± 0.004	0.157 ± 0.004	0.079 ± 0.004	0.315 + 0.012 / - 0.004	0.484 ± 0.039

Company reserves the right to improve product design , functions and reliability without notice.

Marking Code

Part Number	Marking Code
CJ1012-G	C

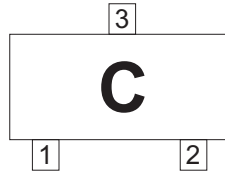

Suggested PAD Layout

SIZE	SOT-523	
	(mm)	(inch)
A	0.60	0.024
B	0.50	0.020
C	0.40	0.016
D	1.00	0.039
E	1.24	0.049
F	1.84	0.072

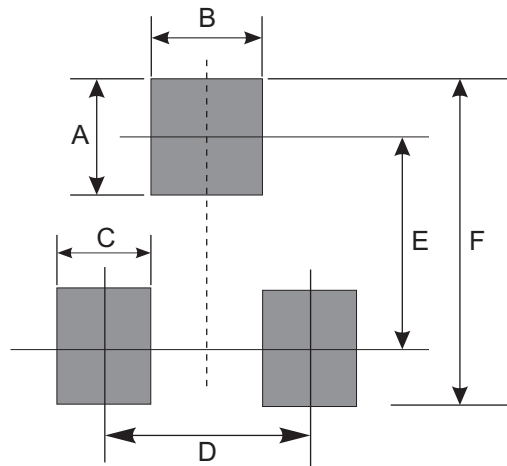

Standard Packaging

Case Type	REEL PACK	
	REEL (pcs)	Reel Size (inch)
SOT-523	3,000	7