

CJ2101-G

RoHS Device

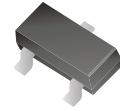

V(BR)DSS	RDS(on)MAX	ID
-20V	100mΩ @ -4.5V	-1.4A
	140mΩ @ -2.5V	
	210mΩ @ -1.8V	

Features

- P-Channel MOSFET
- Leading trench technology for low R_{DS(on)} extending battery life

Mechanical data

- Case: SOT-323, molded plastic.
- Terminals: Solderable per MIL-STD-750, method 2026.
- Weight: 0.008 grams(approx.).

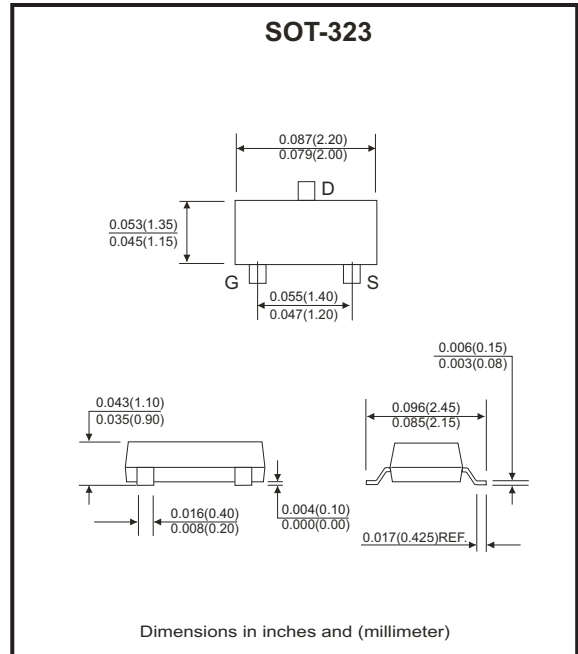

Circuit diagram

- 1. GATE
- 2. SOURCE
- 3. DRAIN

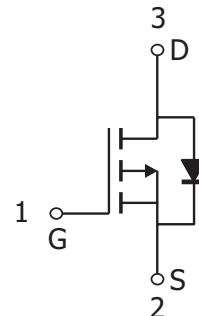

Maximum Ratings (at Ta=25 °C unless otherwise noted)

Parameter	Symbol	Value	Unit
Drain-source voltage	V _{DS}	-20	V
Gate-source voltage	V _{GS}	±8	V
Continuous drain current	I _D	-1.4	A
Pulsed drain current (tp=10μs)	I _{DM}	-3.0	
Power dissipation	P _D	0.29	W
Thermal resistance from junction to ambient	R _{θJA}	431	°C/W
Junction temperature range	T _J	150	°C
Storage temperature range	T _{STG}	-50 ~ +150	°C

Electrical Characteristics (at TA=25°C unless otherwise noted)

Parameter	Symbol	Conditions	Min	Typ	Max	Unit
OFF CHARACTERISTICS						
Drain-source breakdown voltage	V _{DSS}	V _{GS} = 0V , I _D = -250μA	-20			V
Gate-source leakage	I _{GSS}	V _{DS} = 0V , V _{GS} = ±8V			±100	nA
Zero gate voltage drain current	I _{DSS}	V _{DS} = -20V , V _{GS} = 0V			-1	μA
OFF CHARACTERISTICS (note 1)						
Gate-source threshold voltage	V _{GS(th)}	V _{DS} = V _{GS} , I _D = -250μA	-0.45	-0.7		V
Drain-source on-state resistance	R _{DS(on)}	V _{GS} = -4.5V , I _D = -1.0A			100	mΩ
		V _{GS} = -2.5V , I _D = -0.5A			140	
		V _{GS} = -1.8V , I _D = -0.3A			210	
CHARGE AND CAPACITANCES (note 3)						
Input capacitance	C _{iss}	V _{DS} = -8.0V , V _{GS} = 0V, f = 1MHz		640		pF
Output capacitance	C _{oss}			120		
Reverse transfer capacitance	C _{rss}			82		
SWITCHING CHARACTERISTICS (note 2,3)						
Turn-on delay time	t _{d(on)}	V _{GS} = -4.5V , V _{DD} = -4.0V I _D = -1.0A , R _g = 6.2Ω		6.2		nS
Rise time	t _r			15		
Turn-off delay time	t _{d(off)}			26		
Fall time	t _f			18		
DRAIN-SOURCE BODY DIODE CHARACTERISTICS						
Forward Diode Voltage	V _{SD}	V _{GS} = 0V , I _s = -0.3A		-0.62	-1.2	V

Notes:

1. Pulse test: Pulse width ≤ 300μs, Duty cycle ≤ 2%
2. Switching characteristics are independent of operating junction temperature.
3. These parameters have no way to verify.

RATING AND TYPICAL CHARACTERISTIC CURVES (CJ2101-G)

Fig.1 - Output Characteristics

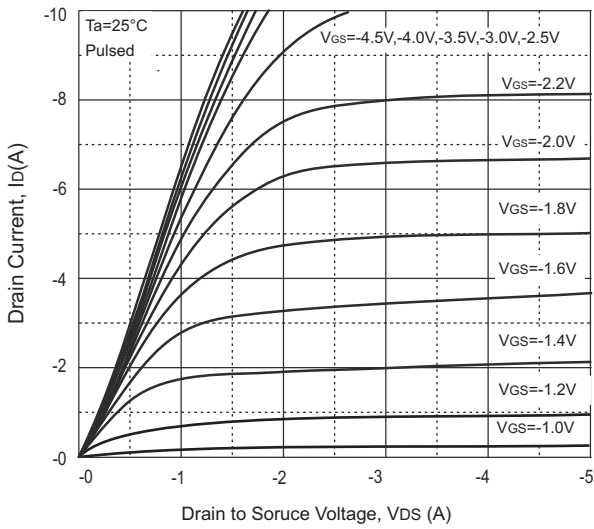

Fig.2 - Transfer Characteristics

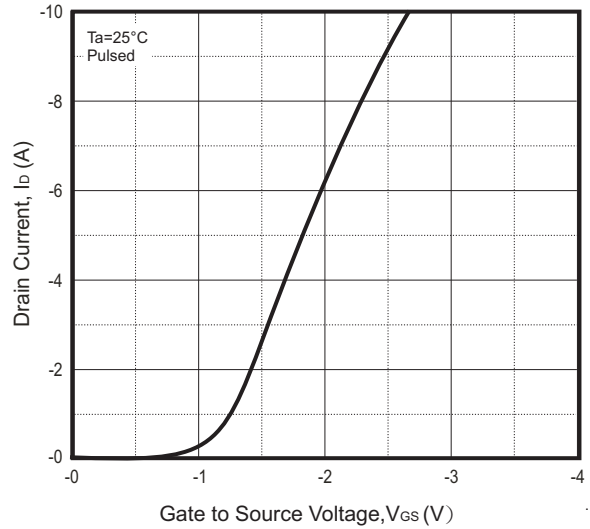

Fig.3 - $R_{DS(ON)} - I_D$

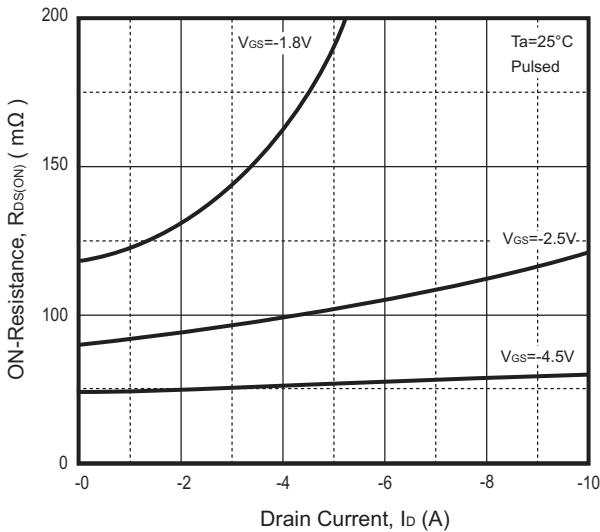

Fig.4 - $R_{DS(ON)} - V_{GS}$

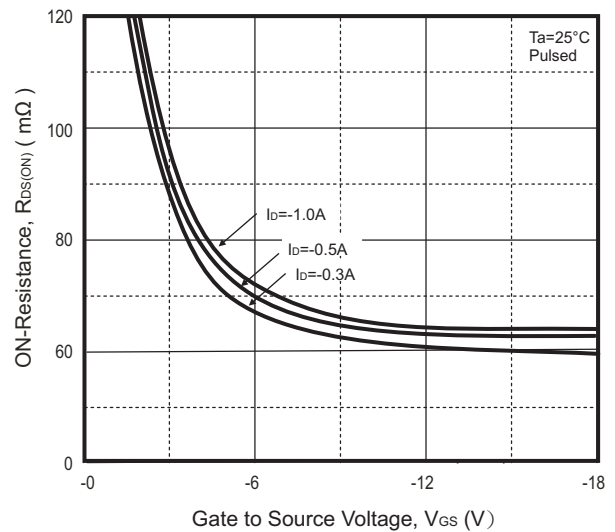
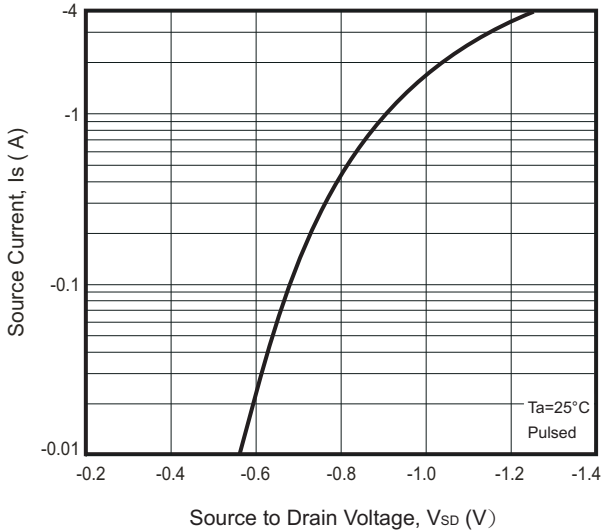
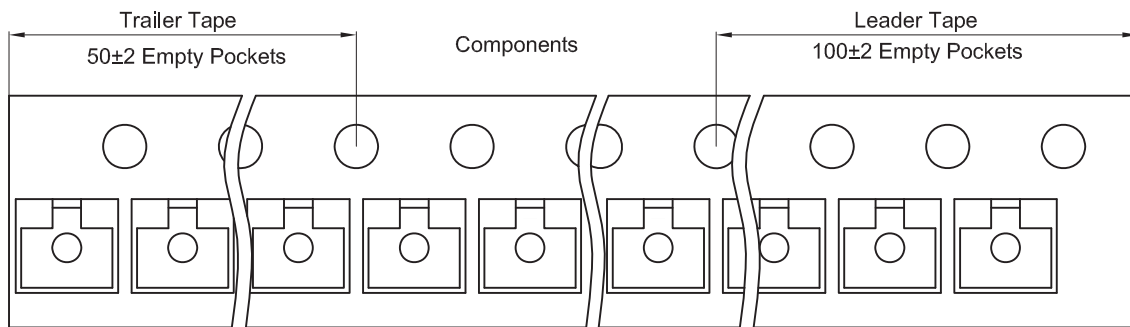
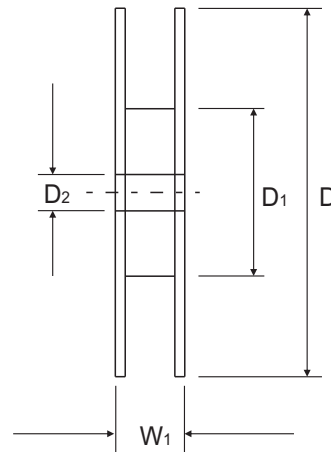
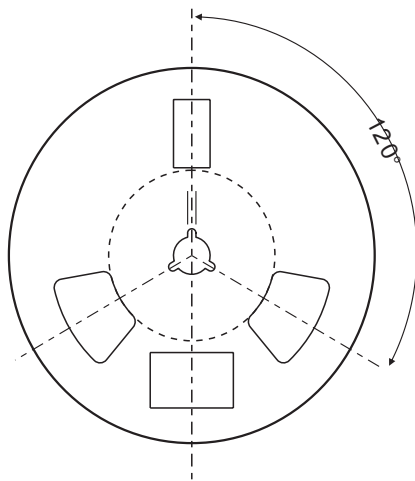
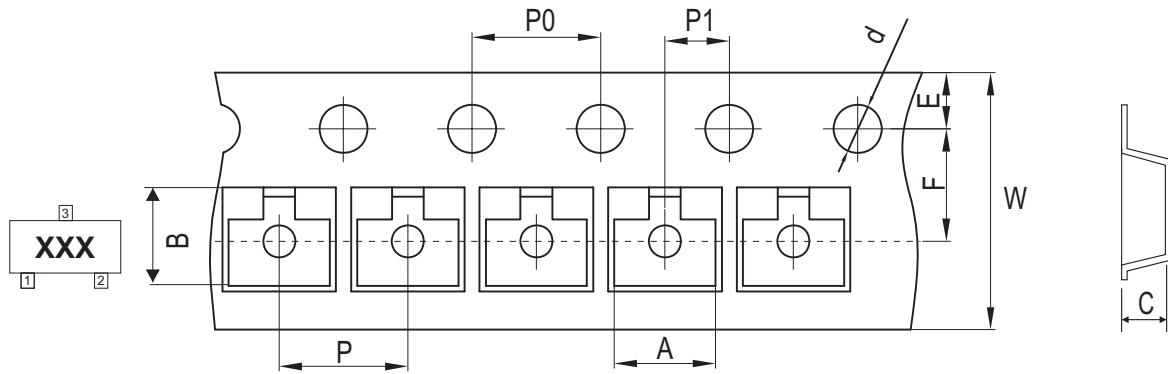

Fig.5 - $I_S - V_{SD}$



Reel Taping Specification



SOT-323	SYMBOL	A	B	C	d	D	D1	D2
	(mm)	2.25 ± 0.05	2.55 ± 0.05	1.19 ± 0.05	1.55 ± 0.10	178.00 ± 2.00	54.40 ± 1.00	13.00 ± 1.00
	(inch)	0.089 ± 0.002	0.100 ± 0.002	0.047 ± 0.002	0.061 ± 0.004	7.008 ± 0.079	2.142 ± 0.039	0.512 ± 0.039

SOT-323	SYMBOL	E	F	P	P0	P1	W	W1
	(mm)	1.75 ± 0.10	3.50 ± 0.10	4.00 ± 0.10	4.00 ± 0.10	2.00 ± 0.10	8.00 + 0.30/-0.10	12.30 ± 1.00
	(inch)	0.069 ± 0.004	0.138 ± 0.004	0.157 ± 0.004	0.157 ± 0.004	0.079 ± 0.004	0.315 + 0.012/-0.004	0.484 ± 0.039

Company reserves the right to improve product design , functions and reliability without notice.

Marking Code

Part Number	Marking Code
CJ2101-G	TS1

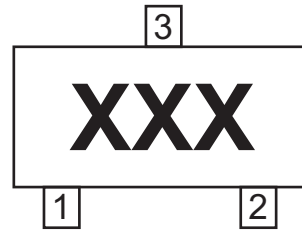

xxx = Product type marking code

Suggested PAD Layout

SIZE	SOT-323	
	(mm)	(inch)
A	0.50	0.020
B	0.80	0.031
C	1.30	0.012
D	2.20	0.087
E	3.00	0.118

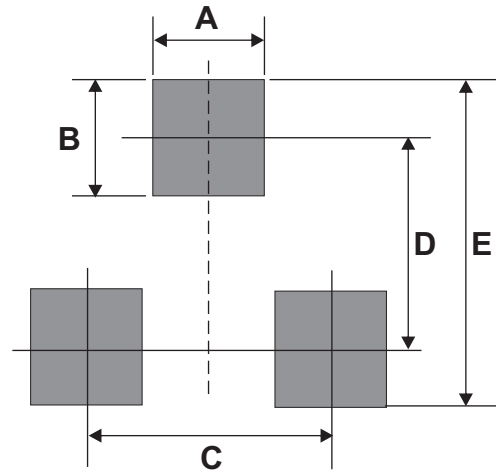

Standard Packaging

Case Type	REEL PACK	
	REEL (pcs)	Reel Size (inch)
SOT-323	3,000	7