

CPDQR12VEU-HF

RoHS Device
Halogen Free

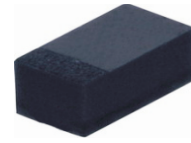

Features

- Uni-directional ESD protection.
- Surface mount package.
- Ultra small SMD package:0402.
- High component density.

Mechanical data

- Case: 0402/SOD-923F standard package, molded plastic.
- Terminals: Gold plated, solderable per MIL-STD-750,method 2026.
- Mounting position: Any.
- Weight: 0.001 grams(approx.).

Circuit Diagram

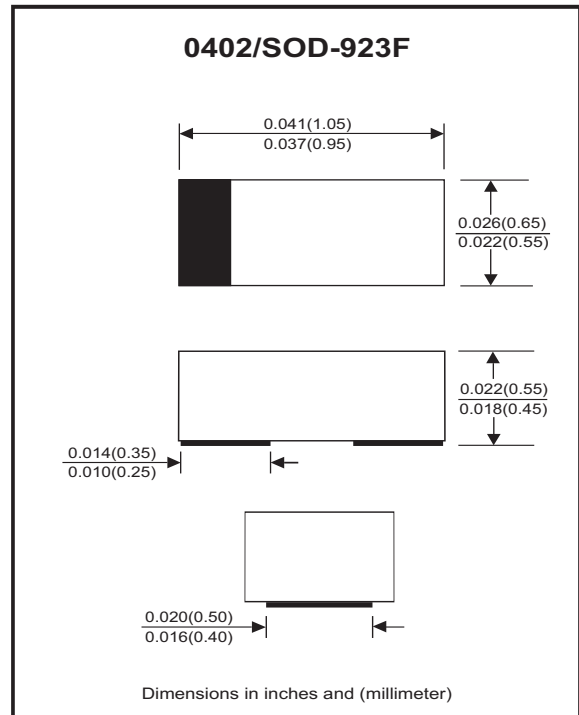

Maximum Rating (at TA=25°C unless otherwise noted)

Parameter	Conditions	Symbol	Value	Unit
Peak pulse power	T _P = 8/20us	P _{PP}	110	W
Peak pulse current	T _P = 8/20us	I _{PP}	5	A
ESD capability	IEC 61000-4-2(air) IEC 61000-4-2(contact)	ESD	±30	kV
Operation temperature range		T _J	-55~+125	°C
Storage temperature range		T _{STG}	-55~+150	°C

Electrical Characteristics (at TA=25°C unless otherwise noted)

Parameter	Conditions	Symbol	Min	Typ	Max	Unit
Working peak reverse voltage		V _{RWM}			12	V
Forward voltage	I _F = 10mA	V _F		0.8		V
Breakdown voltage	I _T = 1mA	V _{BR}	13.5	14.5	15.6	V
Reverse leakage current	V _{RWM} = 12V	I _R		<5	100	nA
Clamping voltage	I _{PP} = 1A, T _P = 8/20us I _{PP} = 5A, T _P = 8/20us	V _C			18 22	V
Junction capacitance	V _R = 0V, f = 1MHz	C _J			60	pF

RATING AND CHARACTERISTIC CURVES (CPDQR12VEU-HF)

Fig.1 - 8/20us Peak Pulse Current Waveform Acc. IEC 61000-4-5

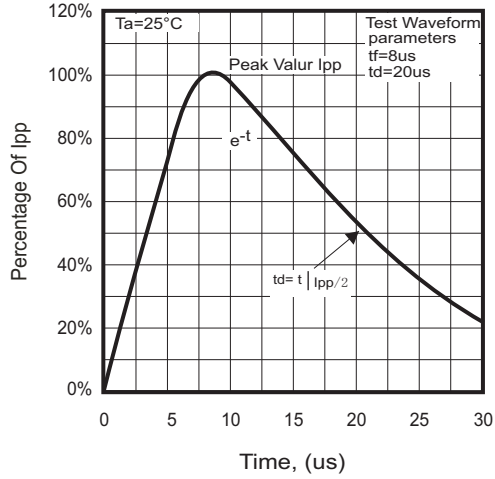

Fig.2 - Power Rating Derating Curve

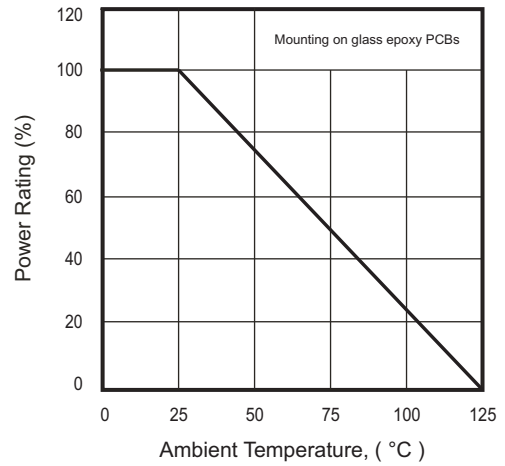

Fig.3 - Clamping Voltage Vs. Peak Pulse Current

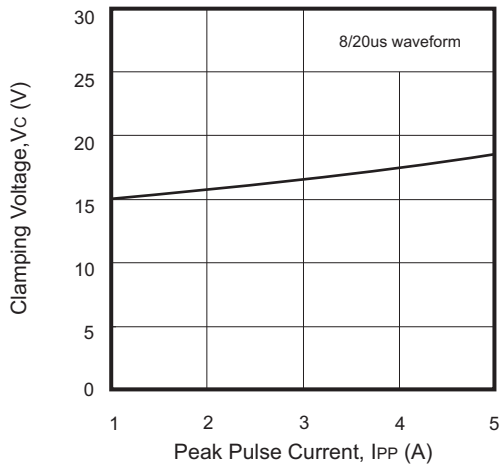
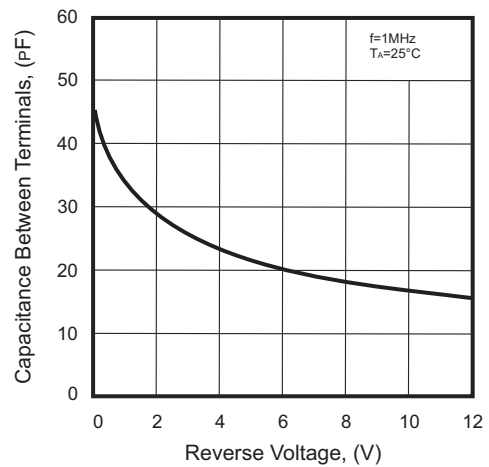
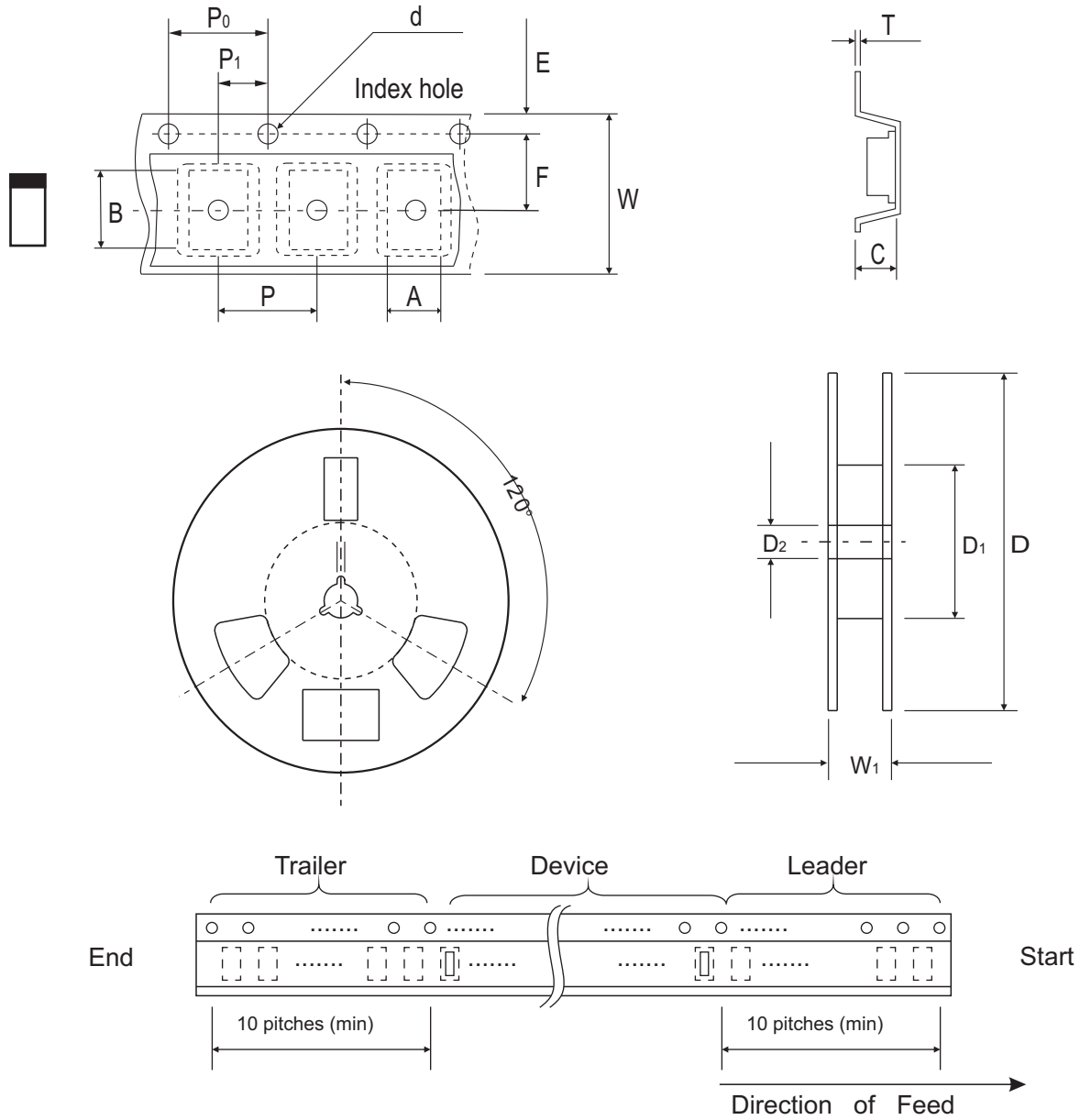

Fig.4 - Capacitance Between Terminals Characteristics



Reel Taping Specification



0402 (SOD-923F)	SYMBOL	A	B	C	d	D	D ₁	D ₂
	(mm)	0.75 ± 0.05	1.17 ± 0.05	0.65 ± 0.05	1.50 + 0.10 - 0	178 ± 1	60.0 + 0.50 - 0	13.0 ± 0.20
	(inch)	0.030 ± 0.002	0.046 ± 0.002	0.026 ± 0.002	0.059 + 0.004 - 0	7.008 ± 0.039	2.362 + 0.020 - 0	0.512 ± 0.008

0402 (SOD-923F)	SYMBOL	E	F	P	P ₀	P ₁	T	W	W ₁
	(mm)	1.75 ± 0.10	3.50 ± 0.10	4.00 ± 0.10	4.00 ± 0.10	2.00 ± 0.10	0.20 + 0.02 - 0.05	8.00 ± 0.20	12.0 + 0.50/-0
	(inch)	0.069 ± 0.004	0.138 ± 0.004	0.157 ± 0.004	0.157 ± 0.004	0.079 ± 0.004	0.008 + 0.001 - 0.002	0.315 ± 0.008	0.472 ± 0.006

Company reserves the right to improve product design, functions and reliability without notice.

Marking Code

Part Number	Marking Code
CPDQR12VEU-HF	E2



Suggested PAD Layout

SIZE	0402/SOD-923F	
	(mm)	(inch)
A	0.750	0.030
B	0.500	0.020
C	0.700	0.028
D	1.250	0.049
E	0.250	0.010

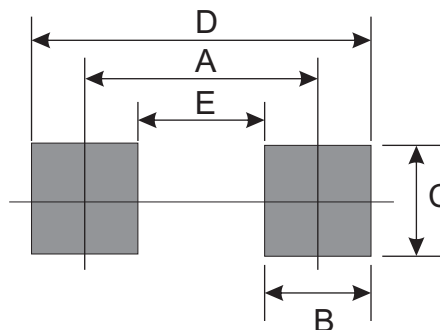

Standard Packaging

Case Type	REEL PACK	
	REEL (pcs)	Reel Size (inch)
0402/SOD-923F	5,000	7