

CPDT-12VEU-HF

RoHS Device
Halogen Free

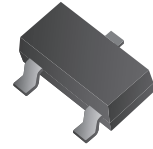

Features

- IEC 61000-4-2 (ESD) ; ± 30 KV (Contact)
- Surface mount package.
- High component density.
- Low clamping voltage.
- Low leakage current.

Mechanical data

- Case: SOT-23 Standard package, molded plastic.
- Terminals: Solderable per MIL-STD-750, method 2026.
- Mounting position: Any.
- Weight: 0.0078 grams(approx.).

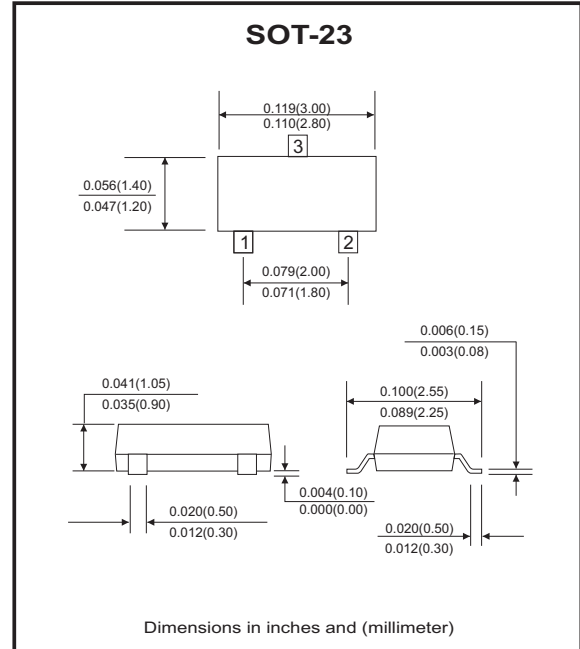

Circuit diagram

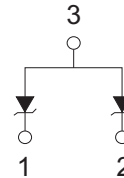

Maximum Rating (at $T_A=25^\circ\text{C}$ unless otherwise noted)

Parameter	Conditions	Symbol	Value	Unit
Peak pulse power	$T_P = 8/20\mu\text{s}$	P_{PP}	110	W
Peak pulse current	$T_P = 8/20\mu\text{s}$	I_{PP}	5	A
ESD capability	IEC 61000-4-2(air) IEC 61000-4-2(contact)	ESD	± 30	kV
Operation temperature range		T_j	-55~+125	$^\circ\text{C}$
Storage temperature range		T_{STG}	-55~+150	$^\circ\text{C}$

Electrical Characteristics (at $T_A=25^\circ\text{C}$ unless otherwise noted)

Parameter	Conditions	Symbol	Min	Typ	Max	Unit
Working peak reverse voltage		V_{RWM}			12	V
Forward voltage	$I_F = 10\text{mA}$	V_F		0.8	1.2	V
Breakdown voltage	$I_T = 1\text{mA}$	V_{BR}	13.5	14.5	15.6	V
Reverse leakage current	$V_{RWM} = 12\text{V}$	I_R		<5	100	nA
Clamping voltage	$I_{PP} = 1\text{A}, T_P = 8/20\mu\text{s}$ $I_{PP} = 5\text{A}, T_P = 8/20\mu\text{s}$	V_C			18 22	V
Junction capacitance	$V_R = 0\text{V}, f = 1\text{MHz}$	C_J			60	pF

RATING AND CHARACTERISTIC CURVES (CPDT-12VEU-HF)

Fig.1 - 8/20us Peak Pulse Current Waveform Acc. IEC 61000-4-5

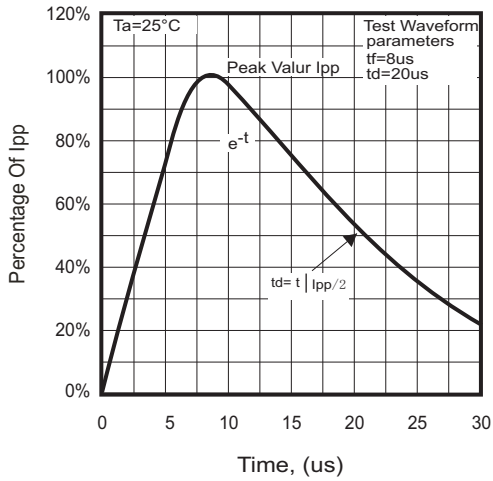

Fig.2 - Power Rating Derating Curve

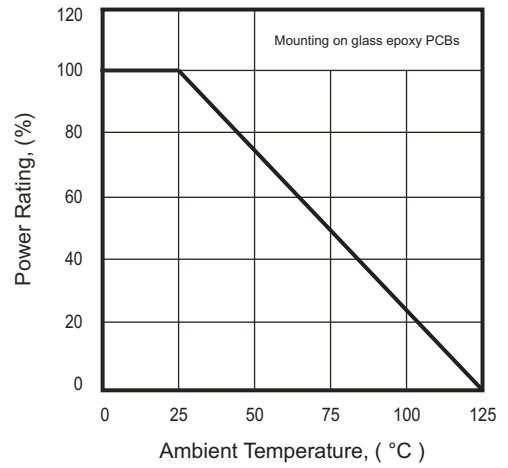

Fig.3 - Clamping Voltage Vs. Peak Pulse Current

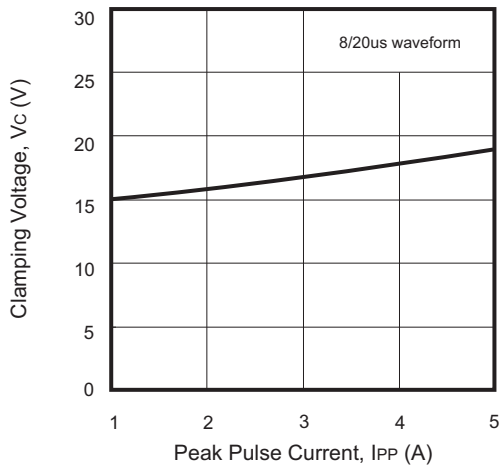
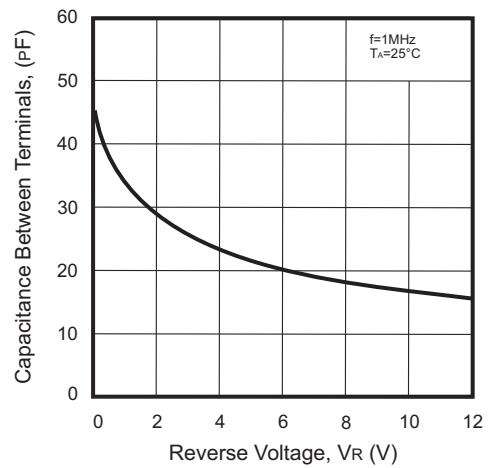
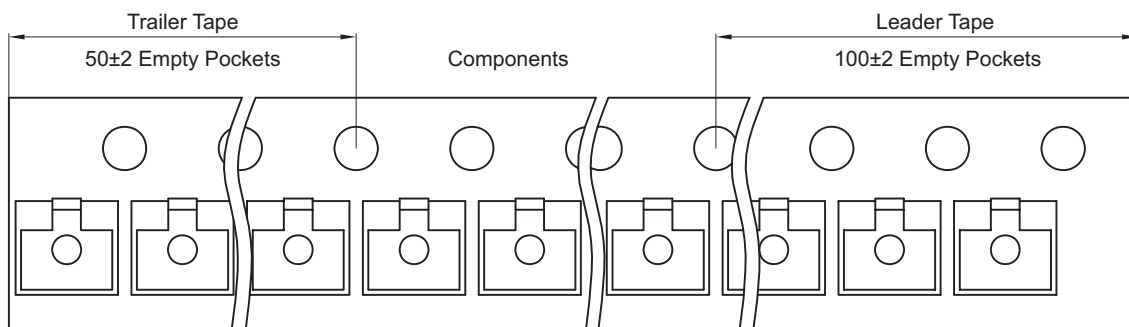
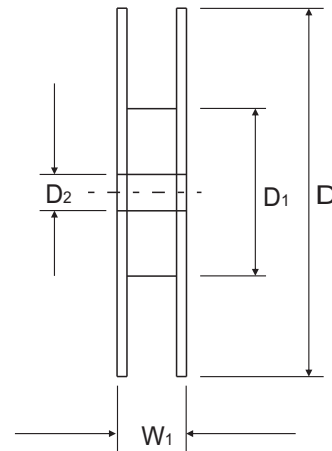
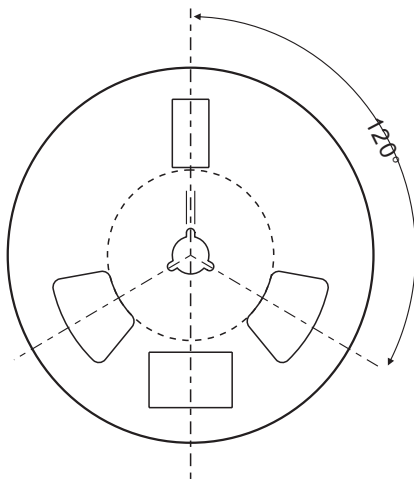
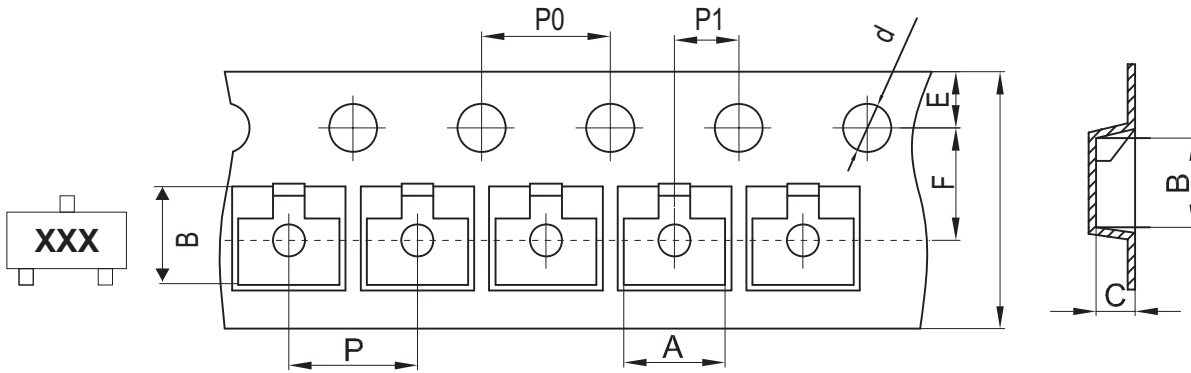

Fig.4 - Capacitance Between Terminals Characteristics



Reel Taping Specification



SOT-23	SYMBOL	A	B	C	d	D	D1	D2
	(mm)	3.15 ± 0.10	2.77 ± 0.10	1.22 ± 0.10	1.50 ± 0.10	178.00 ± 2.00	54.40 ± 1.00	13.00 ± 1.00
	(inch)	0.124 ± 0.004	0.109 ± 0.004	0.048 ± 0.004	0.059 ± 0.004	7.008 ± 0.079	2.142 ± 0.039	0.512 ± 0.039

SOT-23	SYMBOL	E	F	P	P0	P1	W	W1
	(mm)	1.75 ± 0.10	3.50 ± 0.10	4.00 ± 0.10	4.00 ± 0.10	2.00 ± 0.10	8.00 + 0.30 / - 0.10	12.30 ± 1.00
	(inch)	0.069 ± 0.004	0.138 ± 0.004	0.157 ± 0.004	0.157 ± 0.004	0.079 ± 0.004	0.315 + 0.012 / - 0.004	0.484 ± 0.039

Marking Code

Part Number	Marking Code
CPDT-12VEU-HF	E12



Suggested PAD Layout

SIZE	SOT-23	
	(mm)	(inch)
A	0.80	0.031
B	1.90	0.075
C	2.02	0.080
D	2.82	0.111
E	0.80	0.031

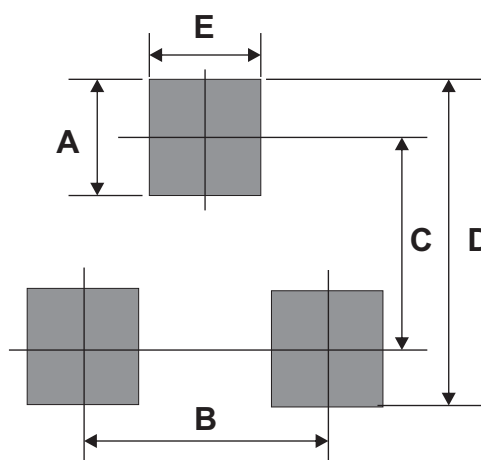

Standard Packaging

Case Type	REEL PACK	
	REEL (pcs)	Reel Size (inch)
SOT-23	3,000	7