

## D882M-G

RoHS Device

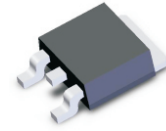

### Features

- Power Dissipation
- High collector current.
- High current gain.
- Low collector-emitter saturation voltage.

### Diagram

- 1. BASE
- 2. COLLECTOR
- 3. EMITTER

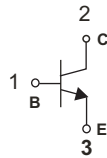

### Maximum Ratings (at TA=25°C unless otherwise noted)

Parameter	Symbol	Value	Unit
Collector-base voltage	V <sub>CB0</sub>	40	V
Collector-emitter voltage	V <sub>CEO</sub>	30	V
Emitter-base voltage	V <sub>EBO</sub>	6	V
Collector current-continuous	I <sub>c</sub>	3	A
Collector power dissipation	P <sub>c</sub>	1.25	W
Junction temperature range	T <sub>J</sub>	150	°C
Storage temperature range	T <sub>STG</sub>	-55 to +150	°C

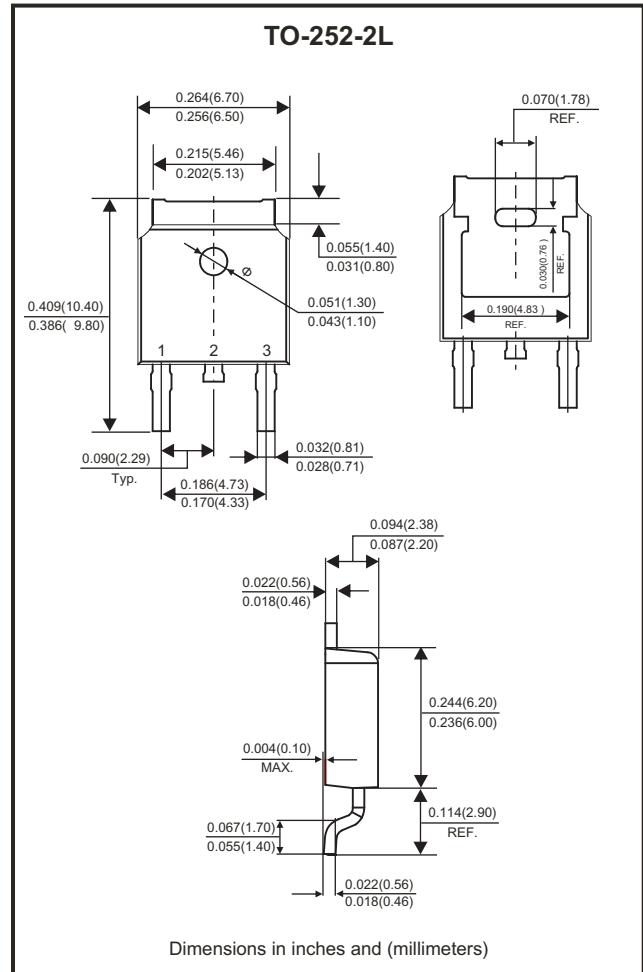

### Electrical Characteristics (at TA=25°C unless otherwise noted)

Parameter	Symbol	Conditions	Min	Typ	Max	Unit
Collector-base breakdown voltage	V <sub>(BR)CBO</sub>	I <sub>c</sub> = 100μA, I <sub>E</sub> = 0	40			V
Collector-emitter breakdown voltage	V <sub>(BR)CEO</sub>	I <sub>c</sub> = 10mA, I <sub>B</sub> = 0	30			V
Emitter-base breakdown voltage	V <sub>(BR)EBO</sub>	I <sub>E</sub> = 100μA, I <sub>c</sub> = 0	6			V
Collector cut-off current	I <sub>CBO</sub>	V <sub>CB</sub> = 40V, I <sub>E</sub> = 0			1	μA
Collector cut-off current	I <sub>CEO</sub>	V <sub>CE</sub> = 30V, I <sub>B</sub> = 0			10	μA
Emitter cut-off current	I <sub>EBO</sub>	V <sub>EB</sub> = 6V, I <sub>c</sub> = 0			1	μA
DC current gain	h <sub>FE</sub>	V <sub>CE</sub> = 2V, I <sub>c</sub> = 1A	100		200	
Collector-emitter saturation voltage	V <sub>CE(sat)</sub>	I <sub>c</sub> = 2A, I <sub>B</sub> = 0.2A			0.5	V
Base-emitter saturation voltage	V <sub>BE(sat)</sub>	I <sub>c</sub> = 2A, I <sub>B</sub> = 0.2A			1.5	V
Transition frequency	f <sub>T</sub>	V <sub>CE</sub> = 5V, I <sub>c</sub> = 0.1A, f = 10MHz		90		MHz

## RATING AND CHARACTERISTIC CURVES (D882M-G)

Fig.1 - Static Characteristic

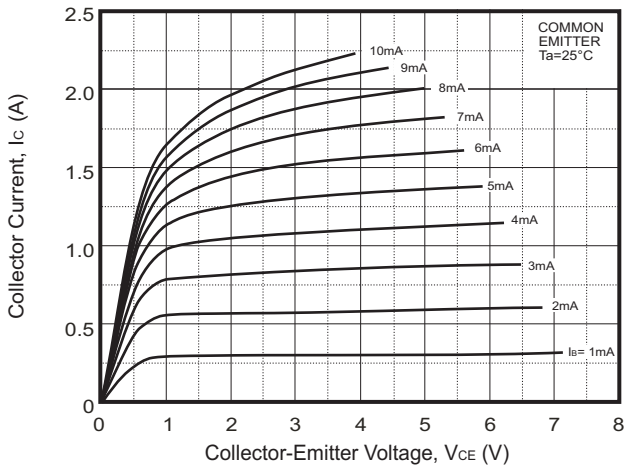

Fig.3 -  $V_{CEsat} - I_c$

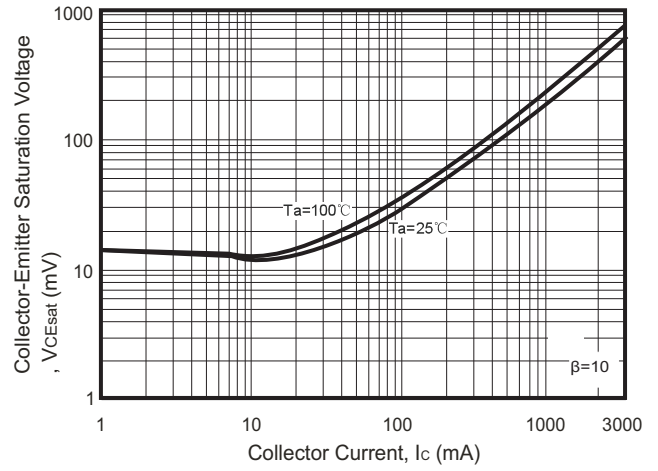

Fig.4 -  $V_{BEsat} - I_c$

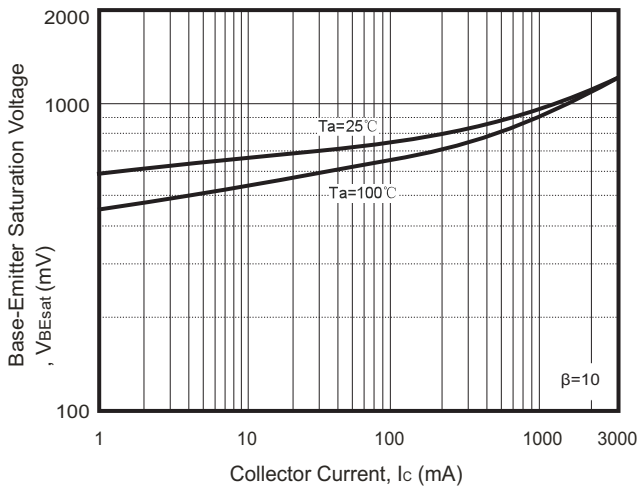

Fig.5 -  $I_c - V_{BE}$

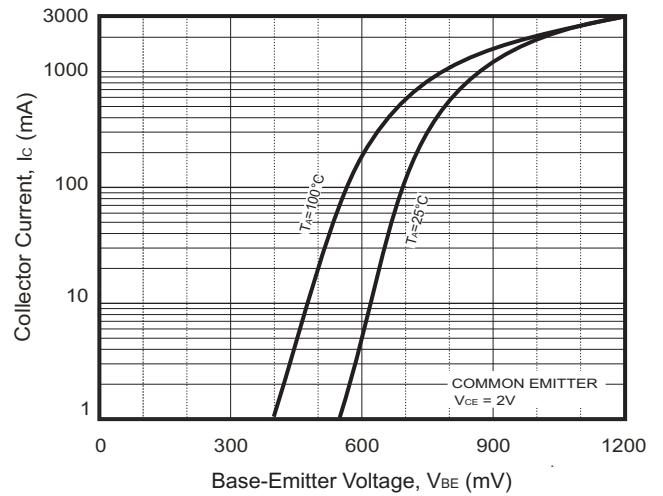

Fig.6 -  $C_{ob} / C_{ib} - V_{CB} / V_{EB}$

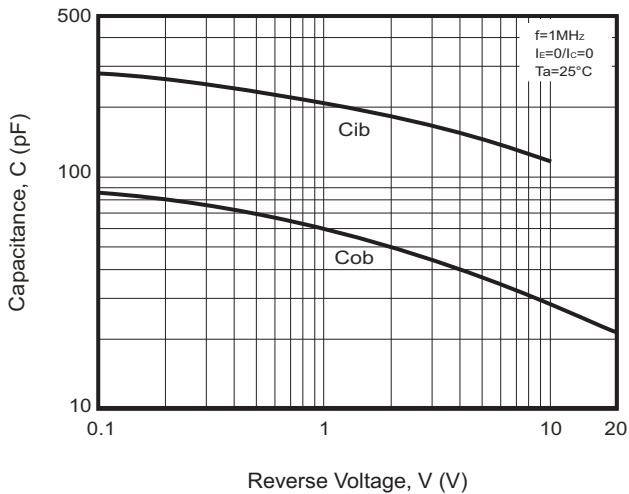
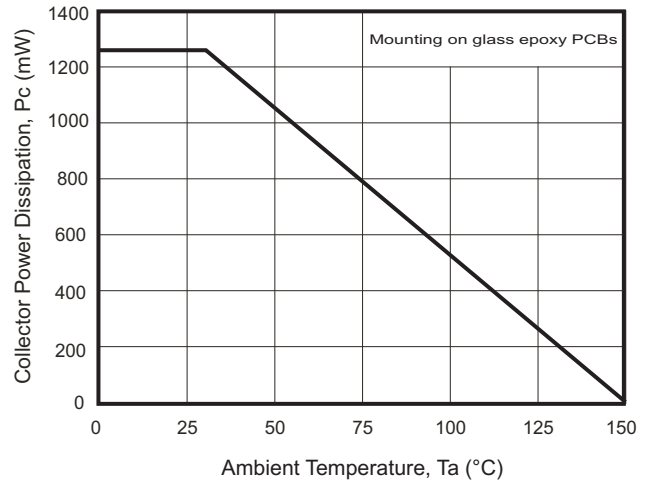
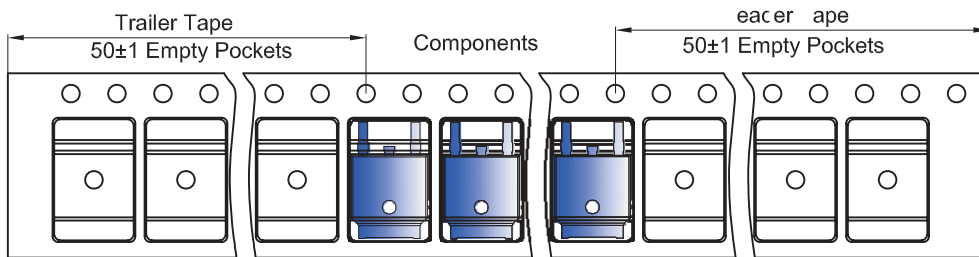
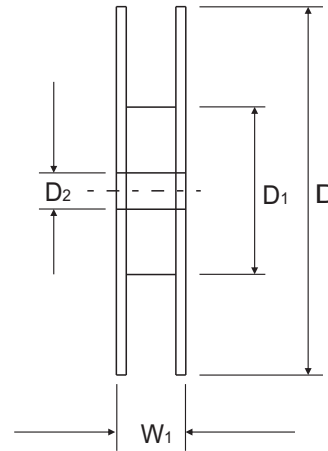
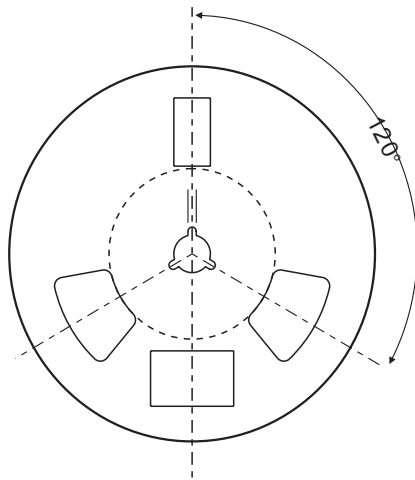
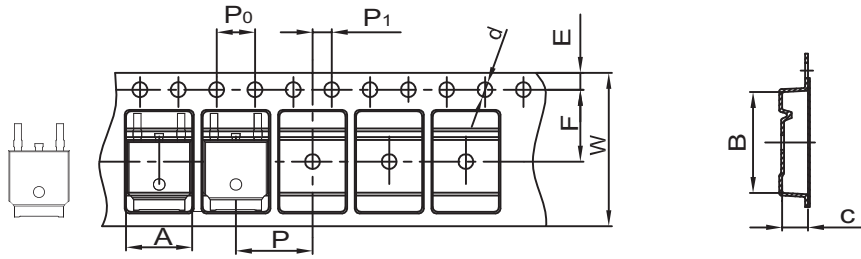

Fig.4 - Typical Power Derating Curve



## Reel Taping Specification



TO-252-2L	SYMBOL	A	B	C	d	D	D <sub>1</sub>	D <sub>2</sub>
	(mm)	6.90 ± 0.10	10.50 ± 0.10	2.70 ± 0.10	Φ1.55 ± 0.10	330.00 ± 2.00	100.00 ± 1.00	21.00 ± 1.00
	(inch)	0.272 ± 0.004	0.413 ± 0.004	0.106 ± 0.004	Φ0.061 ± 0.004	12.992 ± 0.079	3.937 ± 0.039	0.827 ± 0.039

TO-252-2L	SYMBOL	E	F	P	P <sub>0</sub>	P <sub>1</sub>	W	W <sub>1</sub>
	(mm)	1.75 ± 0.10	7.50 ± 0.10	8.00 ± 0.10	4.00 ± 0.10	2.00 ± 0.10	16.00 + 0.30 / -0.10	13.00 ± 1.00
	(inch)	0.069 ± 0.004	0.295 ± 0.004	0.315 ± 0.004	0.157 ± 0.004	0.079 ± 0.004	0.630 + 0.012 / -0.004	0.512 ± 0.039

Company reserves the right to improve product design , functions and reliability without notice.

REV:A

## Marking Code

Part Number	Marking Code
D882M-G	D882M

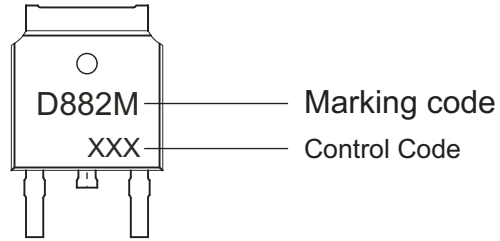

## Suggested PAD Layout

SIZE	TO-252-2L	
	(mm)	(inch)
<b>A</b>	5.80	0.228
<b>B</b>	5.85	0.230
<b>C</b>	3.70	0.146
<b>D</b>	1.20	0.047
<b>E</b>	2.00	0.079
<b>F</b>	4.57	0.180

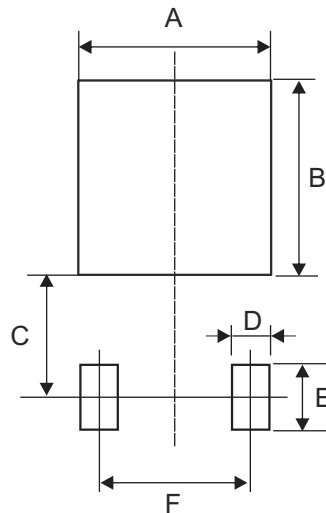

## Standard Packaging

Case Type	REEL PACK	
	REEL ( pcs )	Reel Size (inch)
TO-252-2L	2,500	13