

MMDT3904D-HF (NPN+NPN)

RoHS Device

Halogen Free

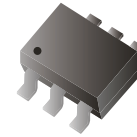

Features

- Epitaxial planar die construction.
- Ideal for low power amplification and switching.
- Ultra small surface mount package.

Mechanical data

- Case: SOT-363 Standard package, molded plastic.
- Terminals: Solderable per MIL-STD-750, method 2026.
- Mounting position: Any.
- Weight: 0.0078 grams(approx.).

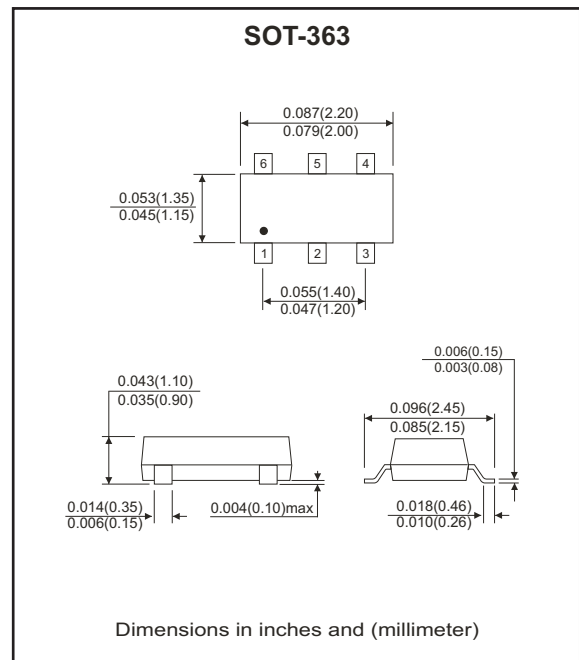
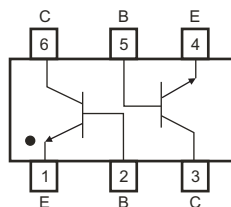

Diagram:

- 1,4 : Emitter
- 2,5 : Base
- 3,6 : Collector



Maximum Ratings (at $T_A=25^\circ\text{C}$ unless otherwise noted)

Parameter	Symbol	Value	Unit
Collector-base voltage	V_{CBO}	60	V
Collector-emitter voltage	V_{CEO}	40	V
Emitter-base voltage	V_{EBO}	5	V
Collector current-continuous	I_C	0.2	A
Collector power dissipation	P_C	0.2	W
Junction temperature range	T_J	150	$^\circ\text{C}$
Storage temperature range	T_{STG}	-55 to +150	$^\circ\text{C}$

Dual General Purpose Transistor

Electrical Characteristics (at $T_A=25^\circ\text{C}$ unless otherwise noted)

Parameter	Conditions	Symbol	Min	Max	Unit
Collector-Base breakdown voltage	$I_C=10\mu\text{A}$, $I_E=0$	$V_{(BR)CBO}$	60		V
Collector-Emitter breakdown voltage	$I_C=1\text{mA}$, $I_B=0$	$V_{(BR)CEO}$	40		V
Emitter-Base breakdown voltage	$I_E=10\mu\text{A}$, $I_C=0$	$V_{(BR)EBO}$	5		V
Collector cut-off current	$V_{CB}=30\text{V}$, $I_E=0$	I_{CBO}		0.05	μA
	$V_{CE}=30\text{V}$, $V_{BE(off)}=3\text{V}$	I_{CEX}		0.05	μA
Emitter cut-off current	$V_{EB}=5\text{V}$, $I_C=0$	I_{EBO}		0.05	μA
DC current gain	$V_{CE}=1\text{V}$, $I_C=0.1\text{mA}$	$h_{FE(1)}$	40		
	$V_{CE}=1\text{V}$, $I_C=1\text{mA}$	$h_{FE(2)}$	70		
	$V_{CE}=1\text{V}$, $I_C=10\text{mA}$	$h_{FE(3)}$	100	300	
	$V_{CE}=1\text{V}$, $I_C=50\text{mA}$	$h_{FE(4)}$	60		
	$V_{CE}=1\text{V}$, $I_C=100\text{mA}$	$h_{FE(5)}$	30		
Collector-emitter saturation voltage	$I_C=10\text{mA}$, $I_B=1\text{mA}$	$V_{CE(sat)1}$		0.2	V
	$I_C=50\text{mA}$, $I_B=5\text{mA}$	$V_{CE(sat)2}$		0.3	V
Base-emitter saturation voltage	$I_C=10\text{mA}$, $I_B=1\text{mA}$	$V_{BE(sat)1}$	0.65	0.85	V
	$I_C=50\text{mA}$, $I_B=5\text{mA}$	$V_{BE(sat)2}$		0.95	V
Transition frequency	$V_{CE}=20\text{V}$, $I_C=10\text{mA}$, $f=100\text{MHz}$	f_T	300		MHz
Collector output capacitance	$V_{CB}=5\text{V}$, $I_E=0$, $f=1\text{MHz}$	C_{ob}		4	pF
Noise figure	$V_{CE}=5\text{V}$, $I_C=0.1\text{mA}$, $f=1\text{KHz}$, $R_s=1\text{K}\Omega$	N_F		5	dB
Delay time	$V_{CC}=3.0\text{V}$, $V_{BE(off)}=-0.5\text{V}$ $I_C=10\text{mA}$, $I_{B1}=-I_{B2}=1\text{mA}$	t_d		35	nS
Rise time		t_r		35	nS
Storage time	$V_{CC}=3.0\text{V}$, $I_C=10\text{mA}$ $I_{B1}=-I_{B2}=1\text{mA}$	t_s		200	nS
Fall time		t_f		50	nS

RATING AND CHARACTERISTIC CURVES (MMDT3904D-HF)

Fig.1 - Static Characteristic

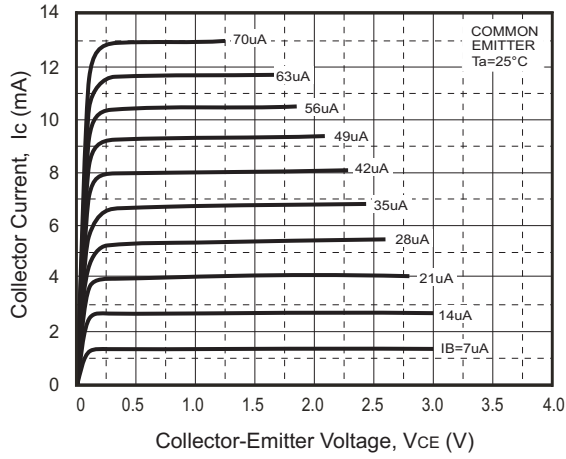

Fig.2 - $h_{FE} - I_c$

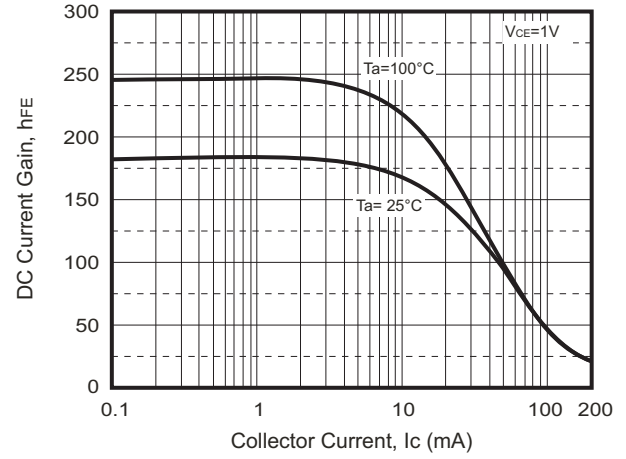

Fig.3 - $V_{BE(sat)} - I_c$

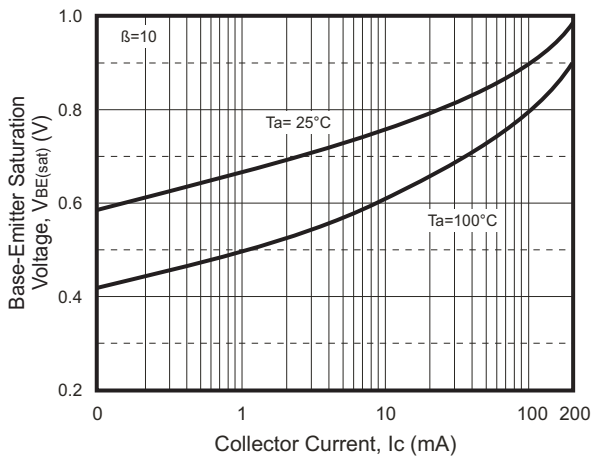

Fig.4 - $V_{CE(sat)} - I_c$

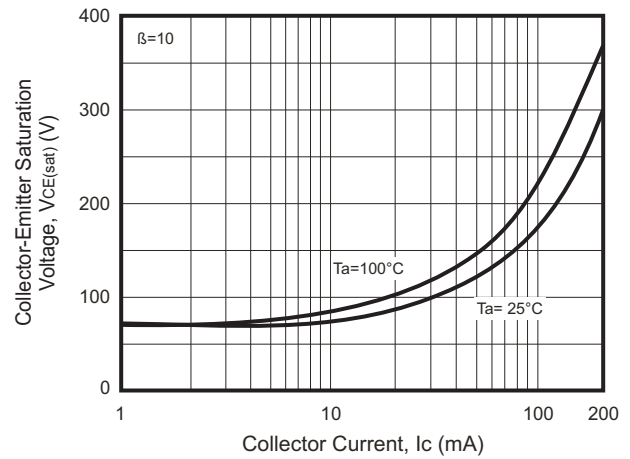

Fig.5 - $I_c - V_{BE}$

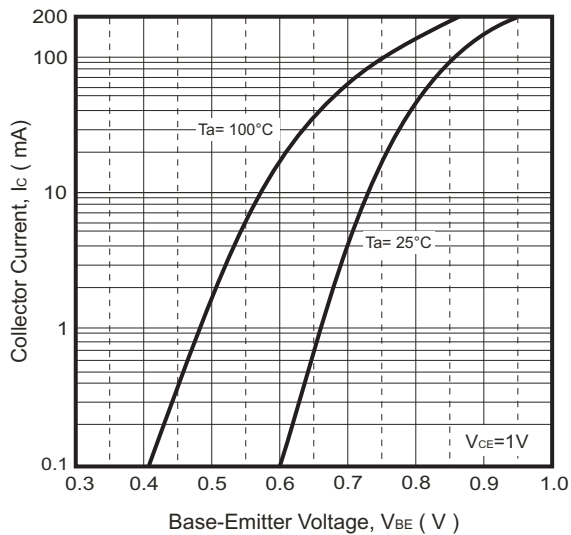
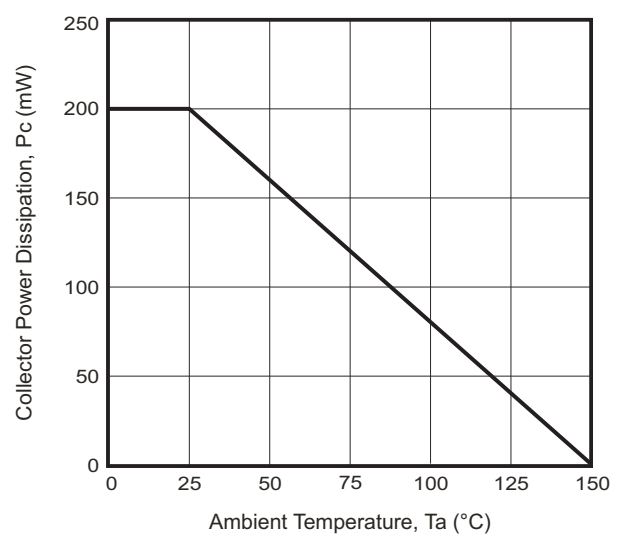

Fig.6 - $P_c - T_a$



Company reserves the right to improve product design, functions and reliability without notice.

REV: A

Reel Taping Specification

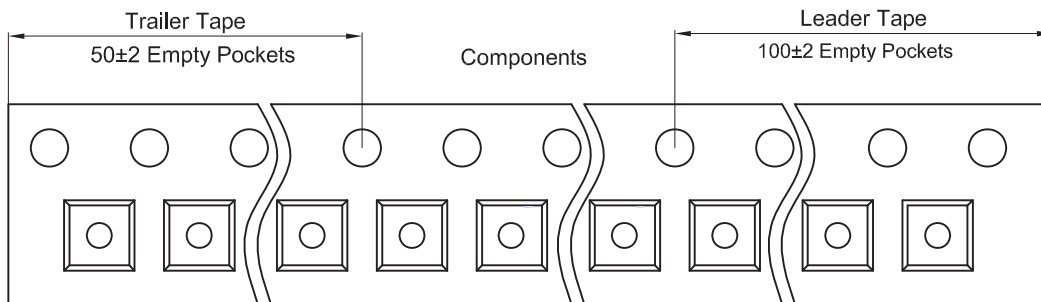
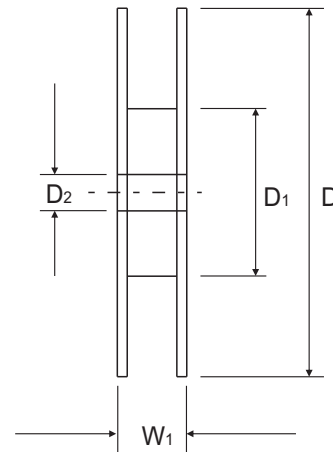
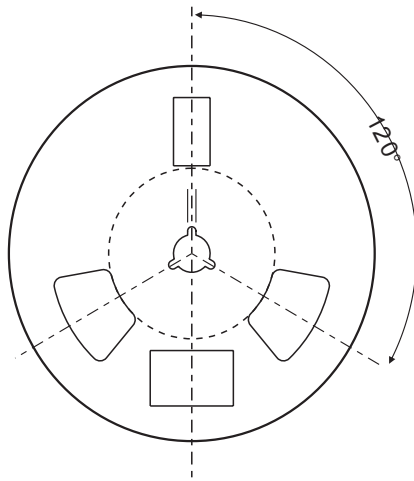
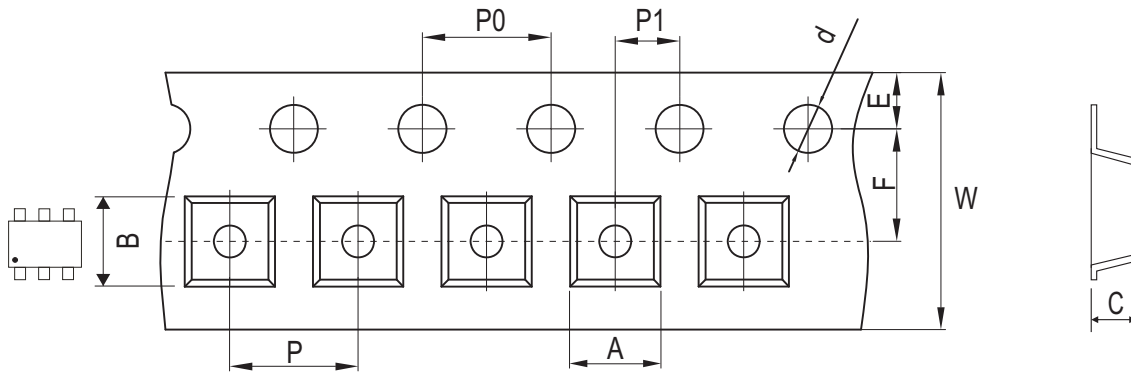

SOT-363	SYMBOL	A	B	C	d	D	D1	D2
	(mm)	2.25 ± 0.10	2.55 ± 0.10	1.20 ± 0.10	1.50 +0.10 - 0.00	178.00 ± 1.00	54.40 ± 0.40	13.00 ± 1.00
	(inch)	0.089 ± 0.004	0.100 ± 0.004	0.047 ± 0.004	0.059 +0.004 - 0.000	7.008 ± 0.039	2.142 ± 0.016	0.512 ± 0.039

SOT-363	SYMBOL	E	F	P	P0	P1	W	W1
	(mm)	1.75 ± 0.10	3.50 ± 0.05	4.00 ± 0.10	4.00 ± 0.10	2.00 ± 0.10	8.00 +0.30 - 0.10	12.30 ± 1.00
	(inch)	0.069 ± 0.004	0.138 ± 0.002	0.157 ± 0.004	0.157 ± 0.004	0.079 ± 0.004	0.315 +0.012 - 0.004	0.484 ± 0.039

Company reserves the right to improve product design, functions and reliability without notice.

REV: A

Marking Code

Part Number	Marking Code
MMDT3904D-HF	. K6N

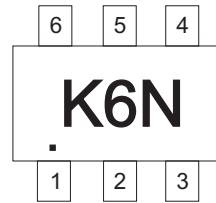

Suggested PAD Layout

SIZE	SOT-363	
	(mm)	(inch)
A	0.40	0.016
B	0.80	0.031
C	0.65	0.026
D	1.94	0.076

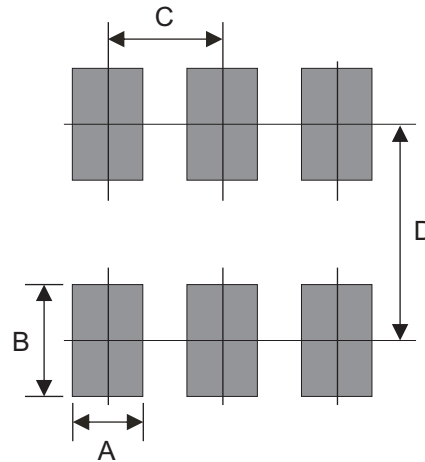

Note:

1. General tolerance: $\pm 0.05\text{mm}$.
2. The pad layout is for reference purposes only.

Standard Packaging

Case Type	REEL PACK	
	REEL (pcs)	Reel Size (inch)
SOT-363	3,000	7