



Frequency Range:

24.00MHz to 60.00MHz

Features:

- High Reliability & Low Cost Unit
- Tight Stability & Extended Temperature Available
- Lead-free Type



Actual Size



QUARTZ
CRYSTALS

■ Standard Specifications

Item	Value
Frequency Range	24.00 to 60.00MHz
Frequency Tolerance	±30ppm (tighter tolerance also available)
Frequency Tolerance over Temperature range	±50ppm (tighter tolerance also available)
Operating Temperature Range	-10 °C to +60 °C (other operating range also available)
Operable Temperature Range	-40 °C to +85 °C
Equivalent Series Resistance (ESR)	Please refer to the ESR Table
Drive Level	50µW Typ. (100µW Max.)
Load Capacitance	8pF (3pF, 4.5pF, 6pF and series also available)
Ageing	±5ppm/year

■ ESR Table

Frequency Range (MHz)	Mode	Standard ESR (Ohm)
24 to 40	AT Cut Fund.	150
40 to 60	AT Cut Fund.	100

Note:

1. Manufacturer reserves the right to change the specification and content of this product for improvement without notification.
2. Custom specification is welcome. Please contact our sales representative for further details.
3. If the crystal is intended for applications which have direct impact on human life and properties, and require a high degree of reliability and safety concerns, customers must provide full information such as but not limit to the application, electrical and reliability specification at the inquiry beginning stage.
4. Customers have to agree to the "Guideline for handling crystal units" and "Standard Terms and Condition of Sales" which is printed this catalog before placing orders to our company or our distributors. There are also unpredictable factors such as applied condition, oscillation margin and etc and customers must check them beforehand. In case of queries, please do not fail to send inquiry to our company before ordering.

Ver.1.2



■ Dimensions (mm) and Solder Pad Layout (mm)

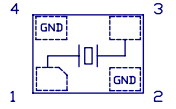
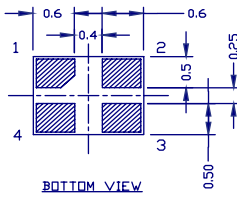
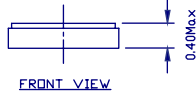
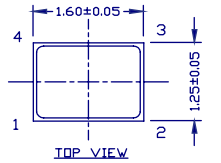

REMARK: 1,3 - CRYSTAL
2,4 - GND

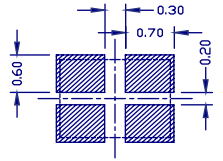

MARKING INFORMATION

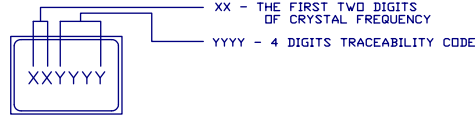

■ Tape & Reel (mm)

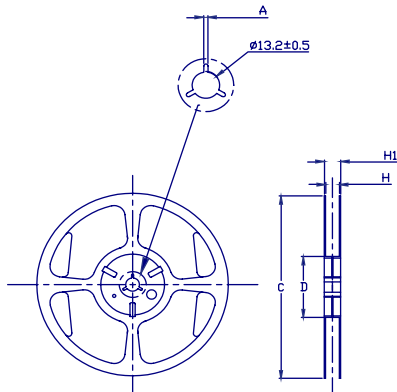
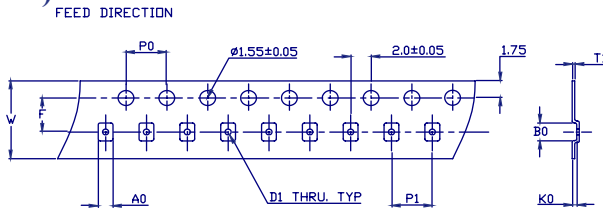

16x1.25 - CT CERAMIC SMD CRYSTAL		
T A P E	W	8.0±0.2
	P1	4.0±0.1
	A0	1.45±0.1
	B0	1.85±0.1
	K0	0.45±0.1
	P0	4.0±0.1
	10P0	40.0±0.1
	F	3.50±0.05
	D1	φ0.6±0.05
	T1	0.25±0.02
R E E L	C	φ178.3
	A	2.5±0.1
	D	φ60.2±0.5
	H	9.0±0.3
	H1	12±1.4
STANDARD PACKING QTY/REEL		3000PCS
MAXIMUM PACKING QTY/REEL		3000PCS

Ver.1.2