

FEATURES

- 3.3V, 5V, 12V and Adjustable output versions
- Adjustable version output voltage range, 1.23V to 57V
- $\pm 4\%$ max over line and load condition
- Available in TO-220, TO-263 and SOP-8PP
- Guaranteed 3A output load current
- Input voltage range up to 60V
- Requires only 4 external components
- Excellent line and load regulation specifications
- 150kHz fixed frequency internal oscillator
- Low power standby mode, I_{STB} typically 30uA
- High efficiency
- Thermal shutdown and current limit protection
- Output short protection by reduction of frequency by 3 times

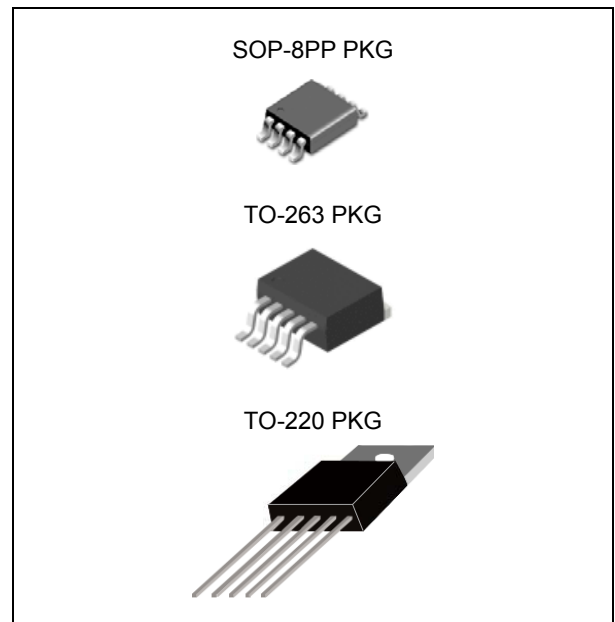

ORDERING INFORMATION

Device	Package
LM2596HVGDP-ADJ	SOP-8PP
LM2596HVGDP-X.X	
LM2596HVGR-ADJ	TO-263 5L
LM2596HVGR-X.X	
LM2596HVGT-ADJ	TO-220 5L
LM2596HVGT-X.X	

X.X = Output Voltage = 3.3, 5.0, 12

APPLICATION

- Simple high-efficiency step-down (buck) regulator
- Efficient pre-regulator for linear regulators
- On-card switching regulators

DESCRIPTION

The LM2596HV series of regulators are monolithic integrated circuits that provide all the active functions for a step-down (buck) switching regulator, capable of driving a 3A load with excellent line and load regulation. These devices are available in fixed output voltages of 3.3V, 5V, 12V, and an adjustable output version.

Available in a standard 5-lead TO-220 package and a 5-lead TO-263 surface mount package.

External shutdown is included, featuring typically 30 μ A standby current. The output switch includes cycle-by-cycle current limiting, as well as thermal shutdown, and protection from output short for full protection under fault conditions.

Absolute Maximum Ratings ^(Note 1)

CHARACTERISTIC	SYMBOL	MIN.	MAX.	UNIT
Supply Voltage	V_{IN}	-	63	V
ON/OFF Pin Input Voltage	$V_{ON/OFF}$	-0.3	60 (or V_{IN})	V
FB pin voltage	V_{FB}	-0.3	25 (or V_{IN})	V
Output voltage to GND	V_{OUT}	-1		V
Storage Temperature Range	T_{STG}	-65	150	$^{\circ}$ C
Maximum Junction Temperature Range	$T_{J,MAX}$	-	150	$^{\circ}$ C

60V, 3A, 150kHz, Step-down Switching Regulator

LM2596HV

Operating Ratings

CHARACTERISTIC	SYMBOL	MIN.	MAX.	UNIT
Supply Voltage	V_{IN}	4.5	60	V
Load Current	I_{LOAD}	-	3.0	A
Temperature Range	T_J	-40	125	°C

Ordering Information

V_{OUT}	Package	Order No.	Description	Supplied As	Status
ADJ	SOP-8PP-8L	LM2596HVGDP-ADJ	3A, 150kHz, Adjustable	Reel	Contact us
	TO-263-5L	LM2596HVGR-ADJ	3A, 150kHz, Adjustable	Reel	Active
	TO-220-5L	LM2596HVGT-ADJ	3A, 150kHz, Adjustable	Tube	Contact us
3.3V	SOP-8PP-8L	LM2596HVGDP-3.3	3A, 150kHz, Fixed	Reel	Contact us
	TO-263-5L	LM2596HVGR-3.3	3A, 150kHz, Fixed	Reel	Contact us
	TO-220-5L	LM2596HVGT-3.3	3A, 150kHz, Fixed	Tube	Contact us
5.0V	SOP-8PP-8L	LM2596HVGDP-5.0	3A, 150kHz, Fixed	Reel	Contact us
	TO-263-5L	LM2596HVGR-5.0	3A, 150kHz, Fixed	Reel	Contact us
	TO-220-5L	LM2596HVGT-5.0	3A, 150kHz, Fixed	Tube	Contact us
12V	SOP-8PP-8L	LM2596HVGDP-12	3A, 150kHz, Fixed	Reel	Contact us
	TO-263-5L	LM2596HVGR-12	3A, 150kHz, Fixed	Reel	Contact us
	TO-220-5L	LM2596HVGT-12	3A, 150kHz, Fixed	Tube	Contact us

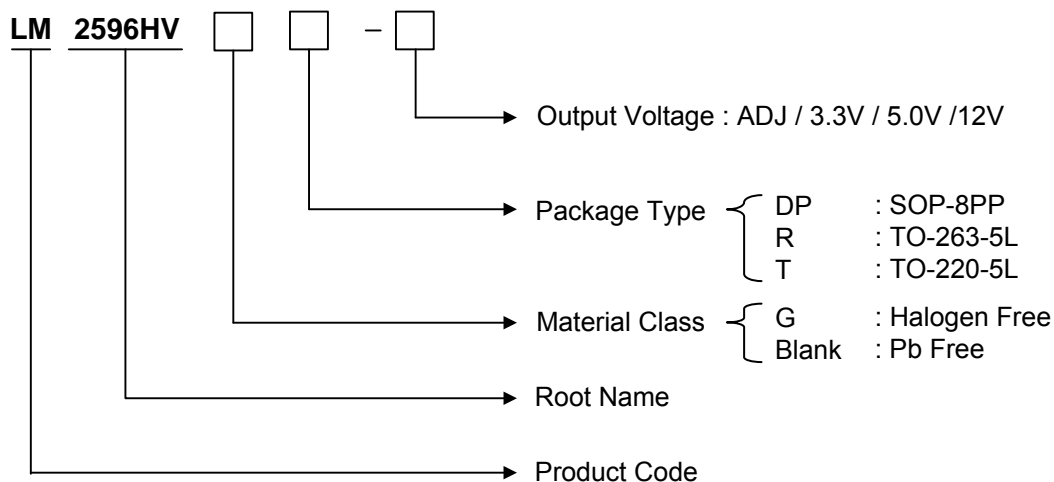

PIN CONFIGURATION

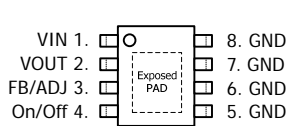

SOP-8PP

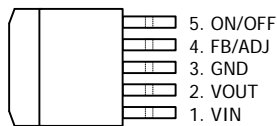

TO-263-5L

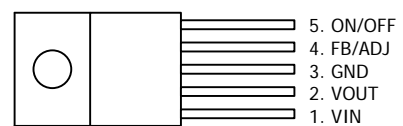

TO-220-5L

PIN DESCRIPTION

Pin No.	TO-263 / TO-220 5 LEAD		Pin No.	SOP-8PP 8 LEAD	
	Name	Function		Name	Function
1	VIN	Input Supply	1	VIN	Input Supply
2	VOUT	Output Voltage	2	VOUT	Output Voltage
3	GND	Ground	3	FB / ADJ	Output Voltage Feedback or Output Adjust
4	FB / ADJ	Output Voltage Feedback or Output Adjust	4	ON/OFF	ON/OFF Shutdown
5	ON/OFF	ON/OFF Shutdown	5 / 6 / 7 / 8	GND	Ground

* Exposed Pad of SOP8-PP package should be externally connected to GND.

TYPICAL APPLICATION

- Fixed Output Voltage Version

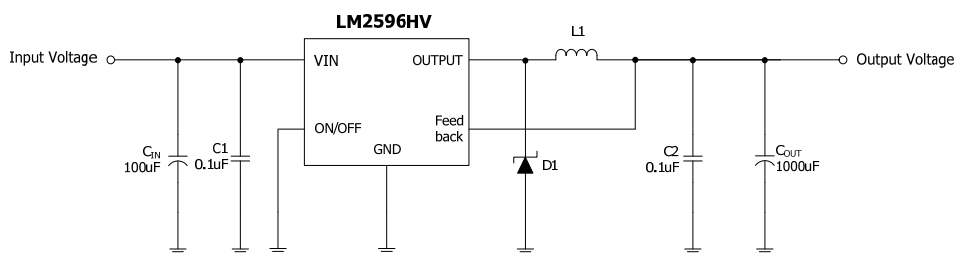

- Adjustable Output Voltage Version

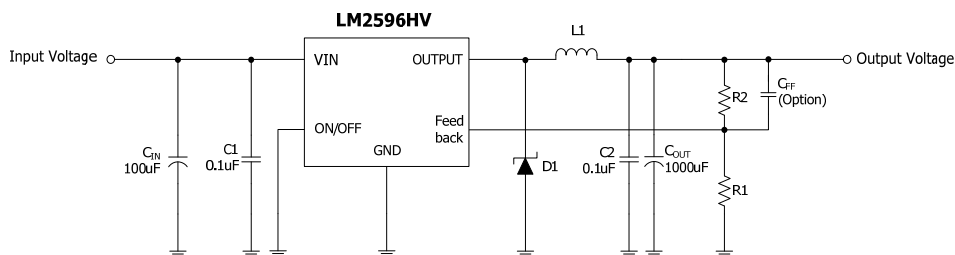

ELECTRICAL CHARACTERISTICS

Unless specified otherwise, $V_{IN} = 12V$ for the 3.3V, 5V and adjustable versions, $I_{LOAD} = 0.5A$, $V_{IN} = 18V$ for 12V version. The boldface type denotes the specifications, which apply over full operating temperature range $T_J = -40$ to $+125^\circ C$.

PARAMETER	SYMBOL	TEST CONDITION ^(Note 2)		MIN.	TYP.	MAX.	UNIT
SYSTEM PARAMETERS ^(Note 3)							
Feedback Voltage	V_{FB}	LM2596HV-ADJ	$8V \leq V_{IN} \leq 60V$, $0.2A \leq I_{LOAD} \leq 3A$	1.193	1.230	1.273	V
				1.180		1.285	
Output Voltage	V_O	LM2596HV-3.3	$5.5V \leq V_{IN} \leq 60V$, $0.2A \leq I_{LOAD} \leq 3A$	3.185	3.30	3.432	V
				3.152		3.465	
		LM2596HV-5.0	$8V \leq V_{IN} \leq 60V$, $0.2A \leq I_{LOAD} \leq 3A$	4.825	5.00	5.20	V
				4.775		5.25	
		LM2596HV-12	$15V \leq V_{IN} \leq 60V$, $0.2A \leq I_{LOAD} \leq 3A$	11.58	12.00	12.48	V
				11.46		12.60	
Line Regulation	Line Reg	$8 \leq V_{IN} \leq 60V$, $I_{LOAD} = 0.2A$			0.3		%
Load Regulation	Load Reg	$10mA \leq I_{LOAD} \leq 3A$, $V_{IN} = 12V$			0.3		%
Efficiency	η	LM2596HV-ADJ	$V_{IN} = 12V$, $I_{LOAD} = 3A$, $V_{OUT} = 5V$		79		%
		LM2596HV-3.3	$V_{IN} = 12V$, $I_{LOAD} = 3A$		77		%
		LM2596HV-5.0	$V_{IN} = 12V$, $I_{LOAD} = 3A$		79		%
		LM2596HV-12	$V_{IN} = 15V$, $I_{LOAD} = 3A$		83		%
DEVICE PARAMETERS							
Quiescent Current	I_Q	$V_{FB} = 12V$ force driver off ^(Note 6)			5	8	mA
Feedback Bias Current	I_{FB}	$V_{FB} = 1.3V$ (Adjustable version only)		-250	-70		nA
				-450			
Shutdown Supply Current	I_{STB}	$V_{ON/OFF} = 5V$, $V_{IN} = 60V$			30	220	uA
						280	
Oscillator Frequency	F_{OSC}	^(Note 8)		133	150	168	KHz
				120		180	
Oscillator Frequency of short Circuit Protect	F_{SCP}	When $V_{OUT} < 40\%$ from nominal, $I_{OUT} = CL$ ^(Note 8)			50		KHz
Max. duty Cycle	$DC_{(MAX.)}$	$V_{FB} = 0V$ force driver on ^(Note 5)		100			%
Min. duty Cycle	$DC_{(MIN.)}$	$V_{FB} = 12V$ force driver off ($V_{FB} = 15V$, For 12V Version)				0	

Current Limit	CL	Peak Current. No outside circuit. $V_{FB}=0V$ (Note 4, 8)	4.1	5.3	6.7	A
			3.8		7.0	
Saturation Voltage	V_{SAT}	$I_{OUT}=3A$. No outside circuit. $V_{FB}=0V$ (Note 4)		1.35	1.50	V
					1.70	
Output Leakage Current	I_L	$V_{OUT}=0V$. No outside circuit. $V_{FB}=12V$ (Note 6, 7)	-300	-50		μA
Output Leakage Current	I_{L1}	$V_{OUT}=-1V$. No outside circuit. $V_{FB}=12V$ (Note 6, 7)	-30	-3		mA
ON/OFF Input Threshold	V_{TH}		0.6	1.3	2.0	V
ON/OFF Input Current	I_H	$V_{ON/OFF}=2.5V$	-5	-0.1	5	μA
	I_L	$V_{ON/OFF}=0.5V$	-1	-0.01	1	μA
Thermal Shutdown Temperature	T_{SD}	T_J		160		$^{\circ}C$

Note 1. Absolute Maximum Ratings indicate limits beyond which damage to the device may occur. Operating Ratings indicate conditions for which the device is intended to be functional, but do not guarantee specific performance limits. For guaranteed specifications and test conditions, see the Electrical Characteristics.

Note 2. All limits guaranteed at room temperature (standard type face) and at temperature extremes (bold type face).

Note 3. External components such as the schottky diode, inductor, input and output capacitors can affect switching regulator system performance. When the 2596HV is used as shown in the Figure 2 test circuit, system performance will be as shown in system parameters section of Electrical Characteristics.

Note 4. Output pin sourcing current. No diode, inductor or capacitor connected to output.

Note 5. Feedback pin removed from output and connected to 0V.

Note 6. Feedback pin removed from output and connected to +12V for the Adjustable, 3.3V, and 5V, versions, and +25V for the 12V and 15V versions, to force the output transistor OFF.

Note 7. $V_{IN}=60V$.

Note 8. The oscillator frequency reduces to approximately 50KHz in the event of an output short or an overload which causes the regulated output voltage to drop approximately 40% from the nominal output voltage. This self protections feature lowers the average power dissipation of the IC by lowering the minimum duty cycle from 5% down to approximately 2%.

TYPICAL OPERATING CHARACTERISTIC

Efficiency vs. IO_{UT}

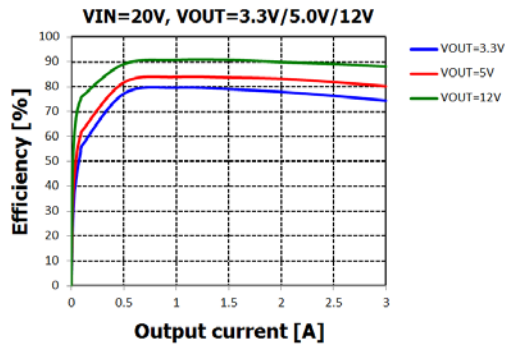

Line Regulation vs. VIN

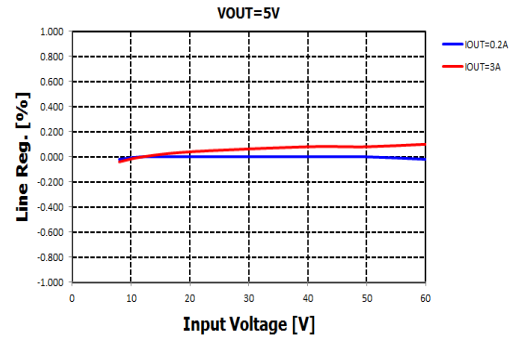

Load Regulation vs. IO_{UT}

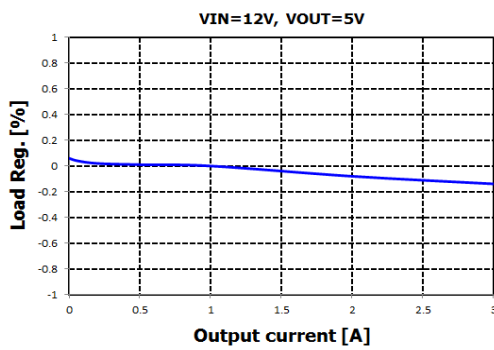

V_{OUT} vs. T_J

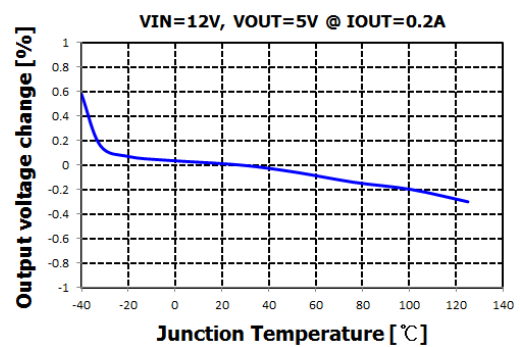

FOSC vs. T_J

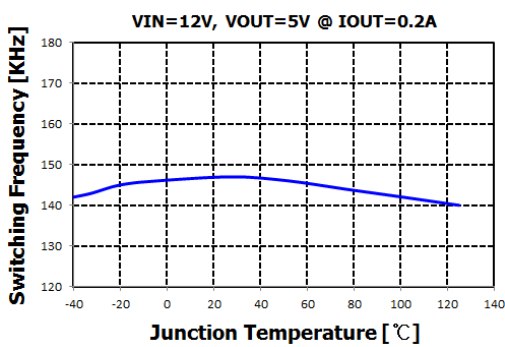

V_{SAT} vs. IO_{UT}

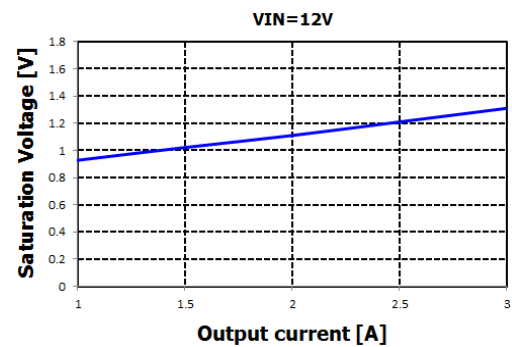

IQ vs. VIN

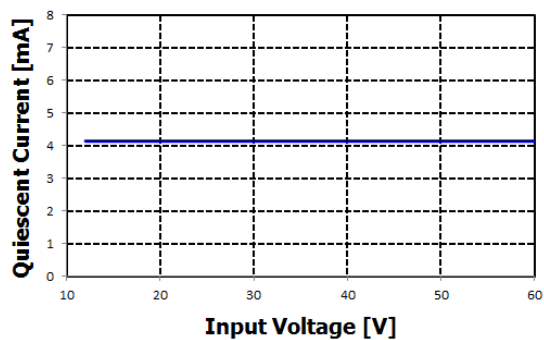

ISTB vs. VIN

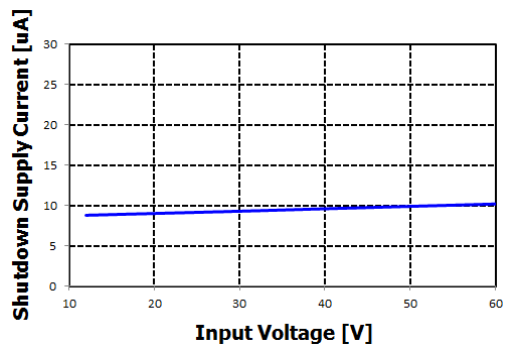

APPLICATION INFORMATION

As in any switching regulator, layout is very important. Rapidly switching currents associated with wiring inductance generate voltage transients which can cause problems. For minimal inductance and ground loops, the length of the wires should be kept as short as possible. Single-point grounding or ground plane construction should be used for best results. Keep the feedback wiring away from the inductor flux

- Fixed Output Voltage Version

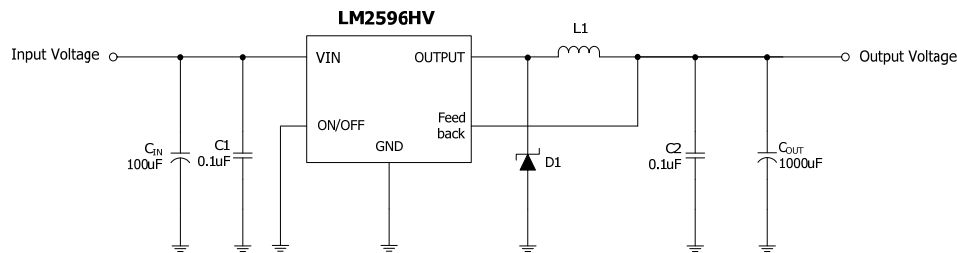

[Figure 1]

- Adjustable Output Voltage Version

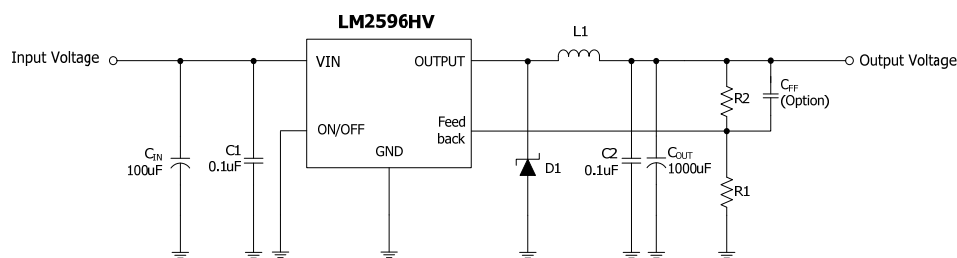

[Figure 2]

$$* V_{OUT} = V_{FB} \left(1 + \frac{R2}{R1}\right)$$

where $V_{FB} = 1.23V$, $R1$ between $1K\Omega$ and $5K\Omega$.

REVISION NOTICE

The description in this datasheet can be revised without any notice to describe its electrical characteristics properly.