

## FEATURES

- Fixed and adjustable output voltages to 1.24V
- 410mV typical dropout at 1A  
Ideal for 3.0V to 2.5V conversion  
Ideal for 2.5V to 1.8V or 1.5V conversion
- 1A minimum guaranteed output current
- 1% initial accuracy
- Low ground current
- Current limiting and thermal shutdown
- Reversed-battery protection
- Reversed-leakage protection
- Fast transient response
- Low-profile SOT-223 package
- Moisture Sensitivity Level 3

## APPLICATION

- Battery Powered Equipments
- Motherboards and Graphic Cards
- Microprocessor Power Supplies
- Peripheral Cards
- High Efficiency Linear Regulators
- Battery Chargers

## DESCRIPTION

The LM39100/1/2 is 1A low-dropout linear voltage regulators that provide low-voltage, high-current output.

The LM39100/1/2 offers extremely low dropout (typically 410mV at 1A) and low ground current (typically 12mA at 1A). The LM39100 is a fixed output regulator offered in the SOT-223 package. The LM39101 and LM39102 are fixed and adjustable regulators, respectively, in SOP-8 and TO-252 Packages.

The LM39100/1/2 is ideal for PC add-in cards that need to convert from standard 5V to 3.3V, 3.3V to 2.5V or 2.5V to 1.8V. A guaranteed maximum dropout voltage of 630mV overall operating conditions allows the LM39100/1/2 to provide 2.5V from a supply as low as 3.13V and 1.8V from a supply as low as 2.43V. The LM39100/1/2 is fully protected with over current limiting, thermal shutdown, and reversed-battery protection. Fixed voltages of 5.0V, 3.3V, 2.5V, 1.8V and 1.5V are available on LM39100/1 with adjustable output voltages to 1.24V on LM39102.

## Absolute Maximum Ratings <sup>(Note 1)</sup>

CHARACTERISTIC	SYMBOL	MIN.	MAX.	UNIT
Supply Voltage	$V_{IN}$	- 0.3	+ 20	V
Enable Voltage	$V_{EN}$	-	+ 20	V
Output Voltage	$V_{OUT}$	-0.3	$V_{IN} + 0.3$	V
Lead Temperature (Soldering, 5 sec)	$T_{SOL}$	-	260	°C
Storage Temperature Range	$T_{STG}$	-65	+ 150	°C

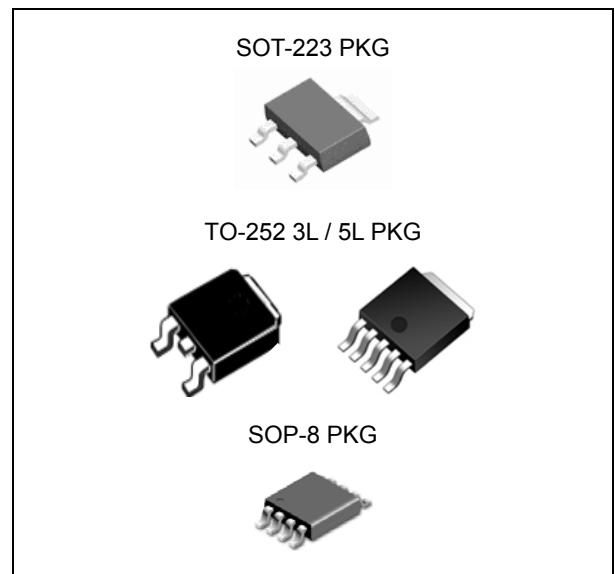

## ORDERING INFORMATION

Device	Package
LM39100S-X.X	SOT-223
LM39100GS-X.X	
LM39100RS-X.X	TO-252 3L
LM39100GRS-X.X	
LM39101RS-X.X	TO-252 5L
LM39101GRS-X.X	
LM39102RS	
LM39102GRS	
LM39101D-X.X	SOP-8
LM39102D	

X.X = Output Voltage = 1.5, 1.8, 2.5, 3.3, 5.0

# 1A Low-Voltage Low-Dropout Regulator

# LM39100/39101/39102

## Operating Ratings (Note 2)

CHARACTERISTIC	SYMBOL	MIN.	MAX.	UNIT
Supply Voltage	$V_{IN}$	+ 2.25	+ 16	V
Enable Voltage	$V_{EN}$	+ 2.25	+ 16	V
Maximum Power Dissipation	$PD_{(max)}$	(Note 3)	(Note 3)	
Junction Temperature	$T_J$	-40	+ 125	°C
Package Thermal Resistance	$\theta_{JA-SOT-223}$	115		°C/W
	$\theta_{JA-TO252}$	95		°C/W
	$\theta_{JA-SOP-8}$	130		°C/W

## Ordering Information

$V_{OUT}$	Package	Order No.	Description	Supplied As	Status
1.5 V	SOT-223	LM39100S-1.5V	1A, Fixed	Reel	Active
	SOT-223	LM39100GS-1.5V	1A, Fixed	Reel	Contact us
	TO-252 3L	LM39100RS-1.5V	1A, Fixed	Reel	Active
	TO-252 3L	LM39100GRS-1.5V	1A, Fixed	Reel	Active
	TO-252 5L	LM39101RS-1.5V	1A, Fixed, Enable	Reel	Active
	TO-252 5L	LM39101GRS-1.5V	1A, Fixed, Enable	Reel	Active
	SOP-8	LM39101D-1.5V	1A, Fixed, Enable	Reel	Active
1.8 V	SOT-223	LM39100S-1.8V	1A, Fixed	Reel	Active
	SOT-223	LM39100GS-1.8V	1A, Fixed	Reel	Contact us
	TO-252 3L	LM39100RS-1.8V	1A, Fixed	Reel	Active
	TO-252 3L	LM39100GRS-1.8V	1A, Fixed	Reel	Active
	TO-252 5L	LM39101RS-1.8V	1A, Fixed, Enable	Reel	Active
	TO-252 5L	LM39101GRS-1.8V	1A, Fixed, Enable	Reel	Active
	SOP-8	LM39101D-1.8V	1A, Fixed, Enable	Reel	Active
2.5 V	SOT-223	LM39100S-2.5V	1A, Fixed	Reel	Active
	SOT-223	LM39100GS-2.5V	1A, Fixed	Reel	Contact us
	TO-252 3L	LM39100RS-2.5V	1A, Fixed	Reel	Active
	TO-252 3L	LM39100GRS-2.5V	1A, Fixed	Reel	Active
	TO-252 5L	LM39101RS-2.5V	1A, Fixed, Enable	Reel	Active
	TO-252 5L	LM39101GRS-2.5V	1A, Fixed, Enable	Reel	Active
	SOP-8	LM39101D-2.5V	1A, Fixed, Enable	Reel	Active
3.3 V	SOT-223	LM39100S-3.3V	1A, Fixed	Reel	Active
	SOT-223	LM39100GS-3.3V	1A, Fixed	Reel	Contact us
	TO-252 3L	LM39100RS-3.3V	1A, Fixed	Reel	Active
	TO-252 3L	LM39100GRS-3.3V	1A, Fixed	Reel	Active
	TO-252 5L	LM39101RS-3.3V	1A, Fixed, Enable	Reel	Active
	TO-252 5L	LM39101GRS-3.3V	1A, Fixed, Enable	Reel	Active
	SOP-8	LM39101D-3.3V	1A, Fixed, Enable	Reel	Active

# 1A Low-Voltage Low-Dropout Regulator LM39100/39101/39102

## Ordering Information

V <sub>OUT</sub>	Package	Order No.	Description	Supplied As	Status
5.0 V	SOT-223	LM39100S-5.0V	1A, Fixed	Reel	Active
	SOT-223	LM39100GS-5.0V	1A, Fixed	Reel	Contact us
	TO-252 3L	LM39100RS-5.0V	1A, Fixed	Reel	Active
	TO-252 3L	LM39100GRS-5.0V	1A, Fixed	Reel	Active
	TO-252 5L	LM39101RS-5.0V	1A, Fixed, Enable	Reel	Active
	TO-252 5L	LM39101GRS-5.0V	1A, Fixed, Enable	Reel	Active
	SOP-8	LM39101D-5.0V	1A, Fixed, Enable	Reel	Active
ADJ	TO-252 5L	LM39102RS	1A, Adjustable, Enable	Reel	Active
	TO-252 5L	LM39102GRS	1A, Adjustable, Enable	Reel	Active
	SOP-8	LM39102D	1A, Adjustable, Enable	Reel	Active

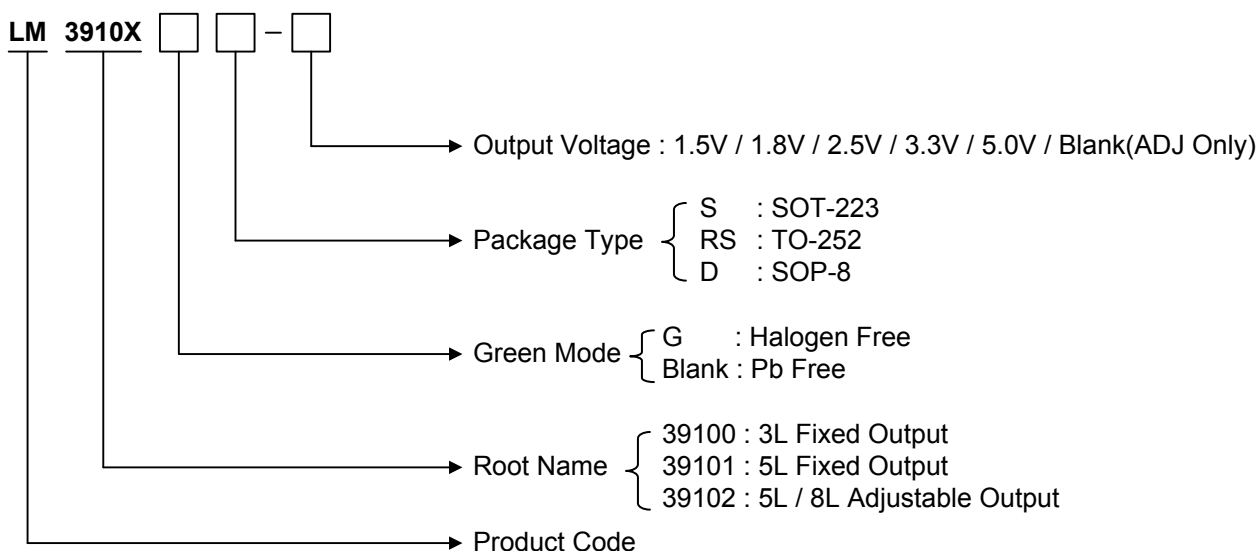

## PIN CONFIGURATION

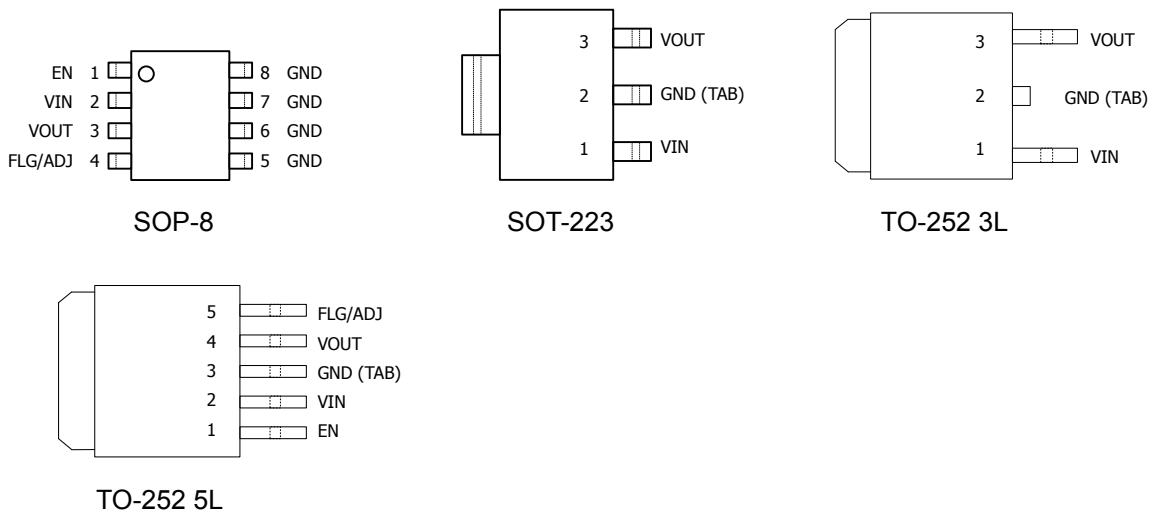

## PIN DESCRIPTION

Pin No.	SOT-223 & TO-252 3L (for 39100)	
	Name	Function
1	VIN	Input Supply
2	GND	Ground
3	VOUT	Output Voltage

Pin No.	TO-252 5L (for 39101/2)		SOP-8 (for 39101/2)	
	Name	Function	Name	Function
1	EN	Chip Enable	EN	Chip Enable
2	VIN	Input Supply	VIN	Input Supply
3	GND	Ground	VOUT	Output Voltage
4	VOUT	Output Voltage	FLG / ADJ	Error Flag Output or Output Adjust
5	FLG / ADJ	Error Flag Output or Output Adjust	GND	Ground
6 / 7 / 8	-	-	GND	Ground

## TYPICAL APPLICATION

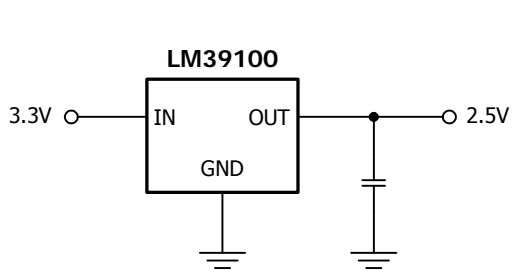

**2.5V / 1A Regulator**

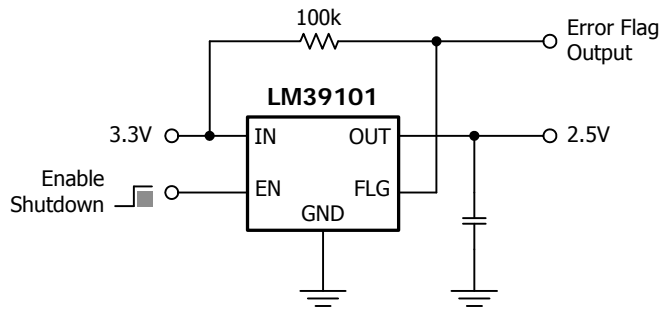

**2.5V / 1A Regulator with Error Flag**

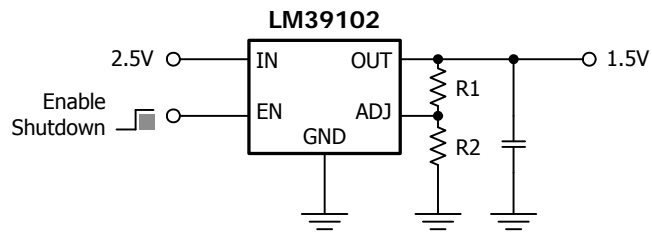

**1.5V / 1A Adjustable Regulator**

## ELECTRICAL CHARACTERISTICS

$V_{IN} = V_{OUT} + 1V$ ;  $V_{EN} = 2.25V$ ;  $T_J = 25^\circ C$ , **bold** values indicate  $-40^\circ C \leq T_J \leq +125^\circ C$ ; unless noted

Symbol	Parameters	Condition	Min.	Typ.	Max.	Unit
$V_{OUT}$	Output Voltage	10mA	-1		1	%
		$10mA \leq I_{OUT} \leq 1A$ , $V_{OUT} + 1V \leq V_{IN} \leq 8V$	<b>-2</b>		<b>2</b>	%
	Line Regulation	$I_{OUT} = 10mA$ , $V_{OUT} + 1V \leq V_{IN} \leq 16V$		0.06	0.5	%
	Load Regulation	$V_{IN} = V_{OUT} + 1V$ , $10mA \leq I_{OUT} \leq 1A$		0.2	1	%
$\Delta V_{OUT}/\Delta T$	Output Voltage Temp. Coefficient (Note 4)			<b>40</b>	<b>100</b>	ppm/°C
$V_{DO}$	Dropout Voltage (Note 5)	$I_{OUT} = 100mA$ , $\Delta V_{OUT} = -1\%$		150	200 <b>250</b>	mV mV
		$I_{OUT} = 500mA$ , $\Delta V_{OUT} = -1\%$		275		mV
		$I_{OUT} = 750mA$ , $\Delta V_{OUT} = -1\%$		330	<b>500</b>	mV
		$I_{OUT} = 1A$ , $\Delta V_{OUT} = -1\%$		410	550 <b>630</b>	mV mV
$I_{GND}$	Ground Current (Note 6)	$I_{OUT} = 100mA$ , $V_{IN} = V_{OUT} + 1V$		700		$\mu A$
		$I_{OUT} = 500mA$ , $V_{IN} = V_{OUT} + 1V$		4		mA
		$I_{OUT} = 750mA$ , $V_{IN} = V_{OUT} + 1V$		7		mA
$I_{OUT(lim)}$	Current Limit	$V_{OUT} = 0V$ , $V_{IN} = V_{OUT} + 1V$		1.8	2.5	A

### Enable Input

$V_{EN}$	Enable Input Voltage	logic low (off)			0.8	V
		logic high (on)	<b>2.25</b>			V
$I_{EN}$	Enable Input Current	$V_{EN} = 2.25V$	1	15	30 <b>75</b>	$\mu A$ $\mu A$
		$V_{EN} = 0.8V$			2 <b>4</b>	$\mu A$ $\mu A$
$T_{EN}$	Delay time to Nominal Output Voltage (Note 7)	$I_{OUT} = 10mA$ , $V_{IN} = V_{OUT} + 1V$ , $V_{EN} = 0V$ to $V_{IN}$		50	500	$\mu s$
		$I_{OUT} = 500mA$ , $V_{IN} = V_{OUT} + 1V$ , $V_{EN} = 0V$ to $V_{IN}$		250	2000	
		$I_{OUT} = 1.0A$ , $V_{IN} = V_{OUT} + 1V$ , $V_{EN} = 0V$ to $V_{IN}$		350	3000	

### Flag Output

$I_{FLG(leak)}$	Output Leakage Current	$V_{OH} = 16V$		0.01	1 <b>2</b>	$\mu A$ $\mu A$
				240	300 400	mV mV
$V_{FLG(do)}$	Output Low Voltage (Note 8)	$V_{IN} = 0.9 \cdot V_{OUT\ NOMINAL}$ , $I_{OL} = 250\mu A$				
$V_{FLG}$	Low Threshold	% of $V_{OUT}$	93			%
	High Threshold	% of $V_{OUT}$			99.2	%
	Hysteresis			1		%

## LM39102 Only

	Reference Voltage		1.228 <b>1.215</b>	1.24	1.252 <b>1.265</b>	V V
		(Note 9)	<b>1.203</b>		<b>1.277</b>	V
	Adjust Pin Bias Current			40	80 <b>120</b>	nA nA
	Reference Voltage Temp. Coefficient (Note 4)			20		ppm/ °C
	Adjust Pin Bias Current Temp. Coefficient			0.1	99.2	nA/ °C

Note 1. Exceeding the absolute maximum ratings may damage the device.

Note 2. The device is not guaranteed to function outside its operating rating.

Note 3.  $PD (max) = (T_{J(max)} - T_A) \div \theta_{JA}$ , where  $\theta_{JA}$  - junction-to-ambient thermal resistance.

Note 4. Output voltage temperature coefficient is  $\Delta V_{OUT} (worst\ case) \div (T_{J(max)} - T_{J(min)})$  where  $T_{J(max)}$  is +125°C and  $T_{J(min)}$  is 0°C.

Note 5.  $V_{DO} = V_{IN} - V_{OUT}$  when  $V_{OUT}$  decreases to 99% of its nominal output voltage with  $V_{IN} = V_{OUT} + 1V$ . For output voltages below 2.25V, dropout voltage is the input-to-output voltage differential with the minimum input voltage being 2.25V. Minimum input operating voltage is 2.25V.

Note 6.  $I_{GND}$  is the quiescent current.  $I_{IN} = I_{GND} + I_{OUT}$ .

Note 7. Delay time is measured after  $V_{EN} = V_{IN}$ .  $C_{IN} = C_{OUT} = 10\mu F$ .

Note 8. For adjustable device and fixed device with  $V_{OUT} \geq 2.5V$

Note 9.  $V_{REF} \leq V_{OUT} \leq (V_{IN} - 1V)$ ,  $2.25V \leq V_{IN} \leq 16V$ ,  $10mA \leq I_L \leq 1A$ .

## TYPICAL OPERATING CHARACTERISTICS

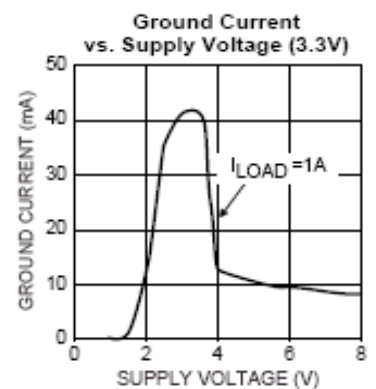
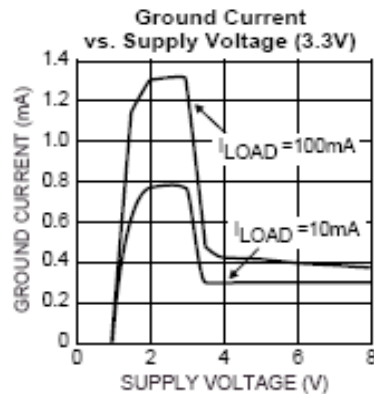
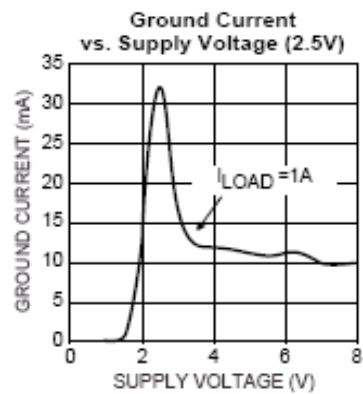
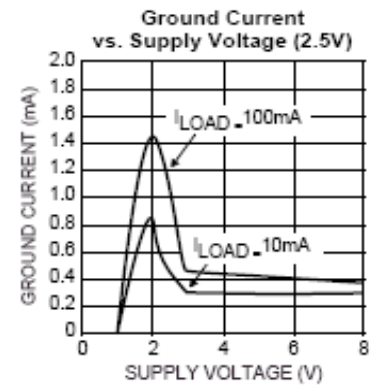
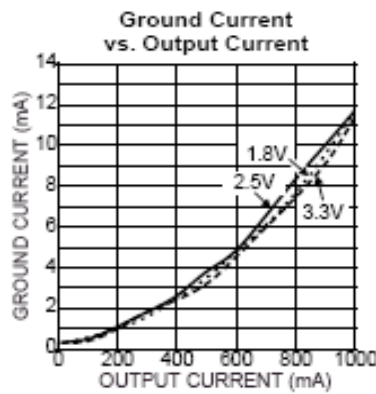
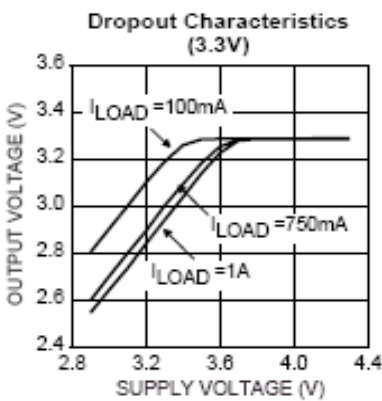
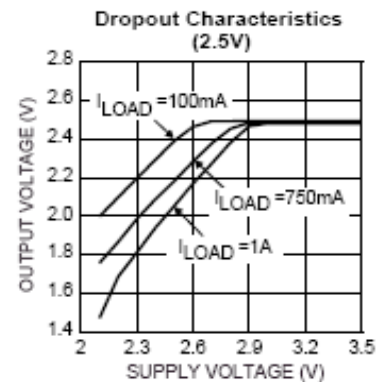
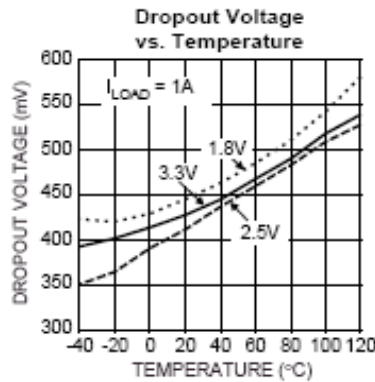
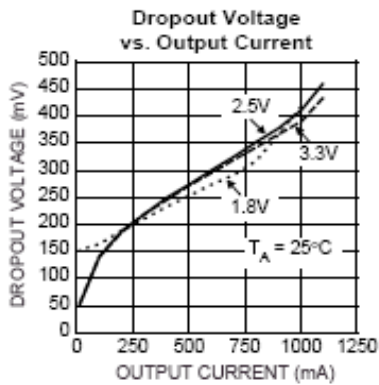



## TYPICAL OPERATING CHARACTERISTICS

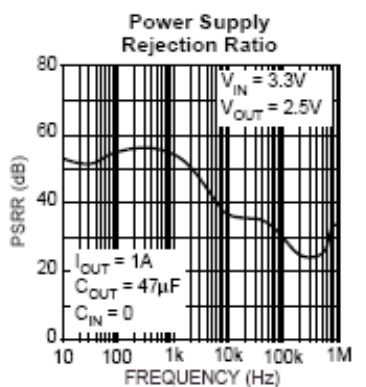
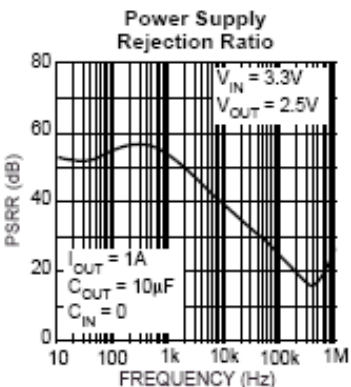
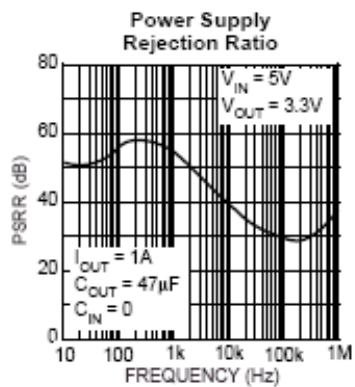
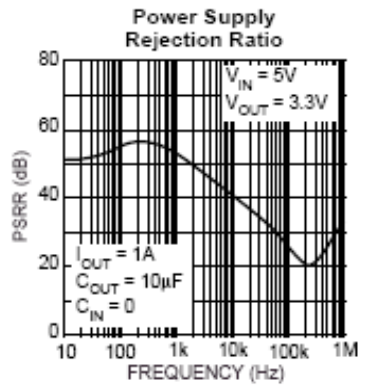
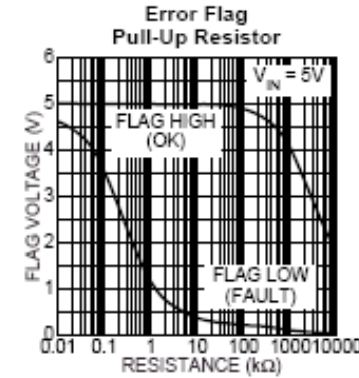
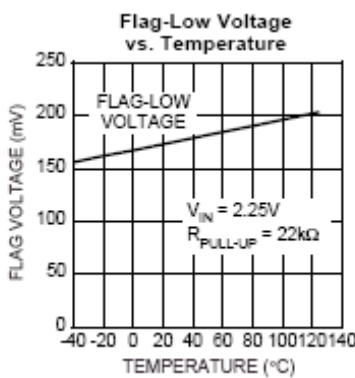
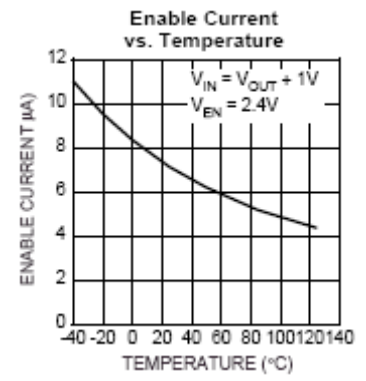
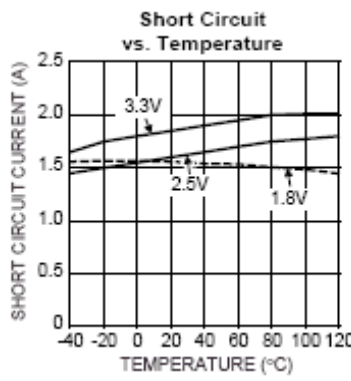
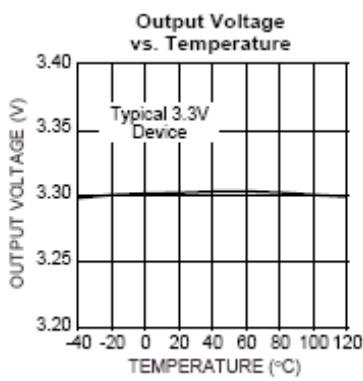
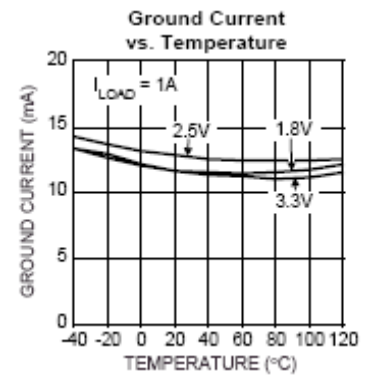
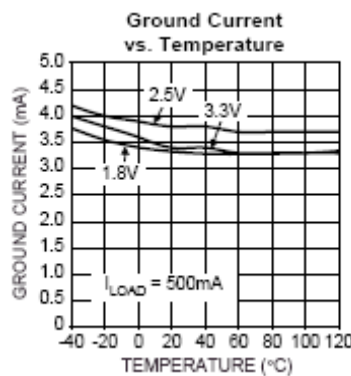
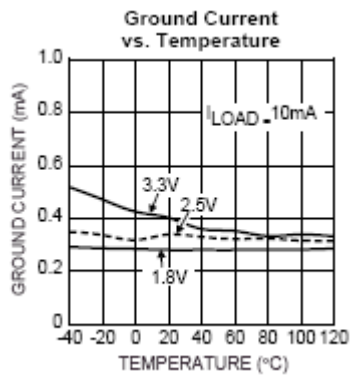

## APPLICATION INFORMATION

The **LM39100/1/2** is a high-performance low-dropout voltage regulator suitable for moderate to high-current voltage regulator applications. Its 630mV dropout voltage at full load and over temperature makes it especially valuable in battery-powered systems and as high-efficiency noise filters in post-regulator applications. Unlike older NPN-pass transistor designs, where the minimum dropout voltage is limited by the base-to-emitter voltage drop and collector-to-emitter saturation voltage, dropout performance of the PNP output of these devices is limited only by the low VCE saturation voltage. A trade-off for the low dropout voltage is a varying base drive requirement.

The LM39100/1/2 regulator is fully protected from damage due to fault conditions. Linear current limiting is provided. Output current during overload conditions is constant. Thermal shutdown disables the device when the die temperature exceeds the maximum safe operating temperature. Transient protection allows device (and load) survival even when the input voltage spikes above and below nominal. The output structure of these regulators allows voltages in excess of the desired output voltage to be applied without reverse current flow.

### Output Capacitor

The LM39100/1/2 requires an output capacitor to maintain stability and improve transient response. Proper capacitor selection is important to ensure proper operation. The LM39100/1/2 output capacitor selection is dependent upon the ESR (equivalent series resistance) of the output capacitor to maintain stability. When the output capacitor is 10 $\mu$ F or greater, the output capacitor should have an ESR less than 2 $\Omega$ . This will improve transient response as well as promote stability. Ultra-low ESR capacitors (<100m $\Omega$ ), such as ceramic chip capacitors, may promote the instability. These very low ESR levels may cause an oscillation and/or underdamped transient response. A low ESR solid tantalum capacitor works extremely well and provides a good transient response and the stability over the temperature range. Aluminum electrolytes can also be used, as long as the capacitor ESR is <2 $\Omega$ . The value of the output capacitor can be increased without limit. Higher capacitance values help one to improve transient response and ripple rejection and reduce an output noise.

### Input Capacitor

An input capacitor of 1 $\mu$ F or greater is recommended when the device is more than 4 inches away from the bulk ac supply capacitance or when the supply is a battery. In the case of ceramic chip capacitor, 10 $\mu$ F capacitance is recommended. Larger values will help to improve ripple rejection by bypassing the input to the regulator, further improving the integrity of the output voltage.

### Error Flag

The LM39101 features an error flag (FLG), which monitors the output voltage and signals an error condition when this voltage drops 5% below its expected value. The error flag is an open-collector output that pulls low under fault conditions and may sink up to 10mA. Low output voltage signifies a number of possible problems, including an over current fault (the device is in current limit) or low input voltage. The flag output is inoperative during over temperature conditions. A pull-up resistor from FLG to either  $V_{IN}$  or  $V_{OUT}$  is required for proper operation. For information regarding the minimum and maximum values of pull-up resistance, refer to the graph in the typical characteristics section of the data sheet.

### Enable Input

The LM39101 and LM39102 versions feature an active-high enable input (EN) that allows on-off control of the regulator. Current drain reduces to “zero” when the device is shutdown, with only micro amperes of leakage current. The EN input has TTL/CMOS compatible thresholds for simple logic interfacing. EN may be directly tied to  $V_{IN}$  and pulled up to the maximum supply voltage

### Transient Response and 3.3V to 2.5V or 2.5V to 1.8V Conversion

The LM39100/1/2 has excellent transient response to variations in input voltage and load current. The device has been designed to respond quickly to load current variations and input voltage variations. Large output capacitors are not required to obtain this performance. A standard 10 $\mu$ F output capacitor, preferably tantalum, is all that is required. Larger values help to improve performance even further.

By virtue of its low-dropout voltage, this device does not saturate into dropout as readily as similar NPN-based de-signs. When converting from 3.3V to 2.5V or 2.5V to 1.8V, the NPN based regulators are already operating in dropout, with typical dropout requirements of 1.2V or greater. To convert down to 2.5V or 1.8V without operating in dropout, NPN-based regulators require an input voltage of 3.7V at the very least. The LM39100 regulator will provide excellent performance with an input as low as 3.0V or 2.5V respectively. This gives the PNP based regulators a distinct advantage over older, NPN based linear regulators.

### Minimum Load Current

The LM39100/1/2 regulator is specified between finite loads. If the output current is too small, leakage currents dominate and the output voltage rises. A 10mA minimum load current is necessary for proper regulation.

### Adjustable Regulator Design

The LM39102 allows programming the output voltage any-where between 1.24V and the 16V maximum operating rating of the family. Two resistors are used. Resistors can be quite large, up to 1M $\Omega$ , because of the very high input impedance and low bias current of the sense comparator: The resistor values are calculated by :  $R1=R2(V_{out}/1.240-1)$  Where  $V_{out}$  is the desired output voltage. Figure 1 shows component definition. Applications with widely varying load currents may scale the resistors to draw the minimum load current required for proper operation (see below). The current consumed by feedback resistors R1 and R2 is calculated by:  $I_{res} = V_{out} / (R1+ R2)$ .

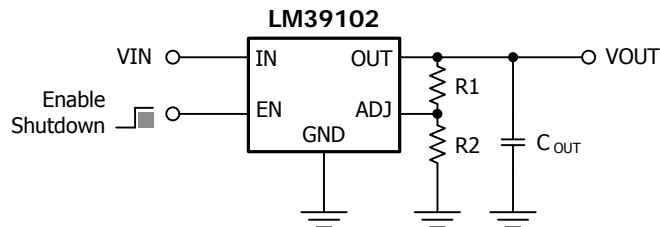

Figure 1. Adjustable Regulator with Resistors

### Maximum Output Current Capability

The LM39100/1/2 can deliver a continuous current of 1A over the full operating junction temperature range. However, the output current is limited by the restriction of power dissipation which differs from packages. A

# 1A Low-Voltage Low-Dropout Regulator LM39100/39101/39102

heat sink may be required depending on the maximum power dissipation and maximum ambient temperature of application. With respect to the applied package, the maximum output current of 1A may be still undeliverable due to the restriction of the power dissipation of LM39100/1/2. Under all possible conditions, the junction temperature must be within the range specified under operating conditions. The temperatures over the device are given by:

$$T_C = T_A + P_D \times \theta_{CA} / \quad T_J = T_C + P_D \times \theta_{JC} / \quad T_J = T_A + P_D \times \theta_{JA}$$

Where  $T_J$  is the junction temperature,  $T_C$  is the case temperature,  $T_A$  is the ambient temperature,  $P_D$  is the total power dissipation of the device,  $\theta_{CA}$  is the thermal resistance of case-to-ambient,  $\theta_{JC}$  is the thermal resistance of junction-to-case, and  $\theta_{JA}$  is the thermal resistance of junction to ambient. The total power dissipation of the device is given by:

$$\begin{aligned} P_D &= P_{IN} - P_{OUT} = (V_{IN} \times I_{IN}) - (V_{OUT} \times I_{OUT}) \\ &= (V_{IN} \times (I_{OUT} + I_{GND})) - (V_{OUT} \times I_{OUT}) = (V_{IN} - V_{OUT}) \times I_{OUT} + V_{IN} \times I_{GND} \end{aligned}$$

Where  $I_{GND}$  is the operating ground current of the device which is specified at the Electrical Characteristics. The maximum allowable temperature rise ( $T_{Rmax}$ ) depends on the maximum ambient temperature ( $T_{Amax}$ ) of the application, and the maximum allowable junction temperature ( $T_{Jmax}$ ):

$$T_{Rmax} = T_{Jmax} - T_{Amax}$$

The maximum allowable value for junction-to-ambient thermal resistance,  $\theta_{JA}$ , can be calculated using the formula:

$$\theta_{JA} = T_{Rmax} / P_D = (T_{Jmax} - T_{Amax}) / P_D$$

LM39100/1/2 is available in SOT-223, TO-252, and SOP-8 package. The thermal resistance depends on amount of copper area or heat sink, and on air flow. If the maximum allowable value of  $\theta_{JA}$  calculated above is over 115°C/W for SOT-223 package, 95°C/W for TO-252 package, 130°C/W for SOP-8 package, no heat sink is needed since the package can dissipate enough heat to satisfy these requirements. If the value for allowable  $\theta_{JA}$  falls near or below these limits, a heat sink or proper area of copper plane is required. In summary, the absolute maximum ratings of thermal resistances are as follow:

## Absolute Maximum Ratings of Thermal Resistance

Characteristic	Symbol	Rating	Unit
Thermal Resistance Junction-To-Ambient / SOT-223	$\theta_{JA-SOT-223}$	115	°C/W
Thermal Resistance Junction-To-Ambient / TO-252	$\theta_{JA-TO-252}$	95	°C/W
Thermal Resistance Junction-To-Ambient / SOP-8	$\theta_{JA-SOP-8}$	130	°C/W

No heat sink / No air flow / No adjacent heat source / 20 mm<sup>2</sup> copper area. ( $T_A=25^\circ\text{C}$ )

Power Dissipation(Pd)  
vs. Copper Area (SOP-8)

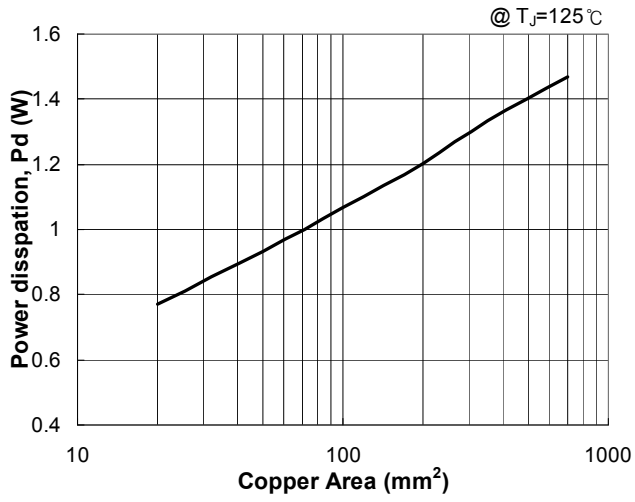

Thermal Resistance(θJA)  
vs. Copper Area (SOP-8)

