

DIODE MODULE

DD60KB

UL:E76102(M)

Power Diode Module **DD60KB** Series are designed for various rectifier circuits. **DD60KB** has two diode chips connected in series and the mounting base is electrically isolated from elements for simple heatsink construction. Wide voltage rating up to, 1600V is available for various input voltages.

- Isolated mounting base
- Two elements in a package for simple (single and three phase) bridge connections
- Highly reliable glass passivated chips
- High surge current capability

(Applications)

- Various rectifiers, Battery chargers, DC motor drives

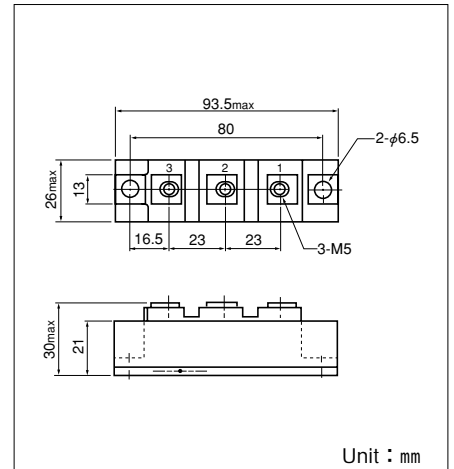
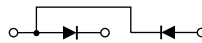

Unit : mm

Maximum Ratings

(T_j=25°C unless otherwise specified)

Symbol	Item	Ratings		Unit
		DD60KB80	DD60KB160	
V _{RRM}	Repetitive Peak Reverse Voltage	800	1600	V
V _{RSM}	Non-Repetitive Peak Reverse Voltage	960	1700	V

Symbol	Item	Conditions	Ratings	Unit	
I _{F(AV)}	Average Forward Current	Single phase, half wave, 180°C conduction, T _c =110°C	60	A	
I _{F(RMS)}	R.M.S. Forward Current	Single phase, half wave, 180°C conduction, T _c =110°C	95	A	
I _{FSM}	Surge Forward Current	½cycle, 50/60Hz, peak value, non-repetitive	1100/1200	A	
I ² t	I ² t	Value for one cycle of surge current	6000	A ² S	
T _j	Operating Junction Temperature		-40 to +150	°C	
T _{stg}	Storage Temperature		-40 to +125	°C	
V _{ISO}	Isolation Breakdown Voltage (R.M.S.)	A.C. 1minute	2500	V	
	Mounting Torque	Mounting (M6)	Recommended Value 2.5-3.9 (25-40)	4.7 (48)	N·m (kgf·cm)
		Terminal (M5)	Recommended Value 1.5-2.5 (15-25)	2.7 (28)	
	Mass	Typical Value	170	g	

Electrical Characteristics

Symbol	Item	Conditions	Ratings	Unit
I _{RRM}	Repetitive Peak Reverse Current, max.	at V _{RRM} Single phase, half wave, T _j =150°C	20	mA
V _{FM}	Forward Voltage Drop, max.	Forward current 180A, Inst measurement	1.35	V
R _{th(j-c)}	Thermal Impedance, max.	Junction to case	0.52	°C/W

