

Eport-E20/Eport-E20-PIN Super Port User Manual

V 1.1



Overview of Characteristic

- ✧ MIPS MCU with **2MB Flash** and **128KB RAM**
- ✧ Use **FreeRTOS** Operation System
- ✧ Support TCP/IP/Telnet/**Modbus** TCP Protocol
- ✧ Support **Serial To 10/100M Ethernet** Conversion, Serial Speed Upto 921600 bps
- ✧ Support 10/100M Ethernet **Auto-Negotiation**
- ✧ Support Easy Configuration Through a **Web** Interface
- ✧ Support Security Protocol Such As **TLS/AES/DES3**
- ✧ Support Web OTA **Wireless Upgrade**
- ✧ Single +3.3V Power Supply
- ✧ Size: 50 x 23 x 11 mm (L x W x H)
- ✧ FCC/CE/RoHS Certificated

TABLE OF CONTENTS TABLE OF CONTENTS

TABLE OF CONTENTS TABLE OF CONTENTS	2
LIST OF FIGURES.....	5
LIST OF TABLES	7
HISTORY.....	7
1. PRODUCT OVERVIEW.....	8
1.1. General Description	8
1.2. Device Parameters.....	8
1.3. Key Application	9
2. HARDWARE INTRODUCTION	10
2.1. Appearance	10
2.2. Eport-E20 Pins Definition.....	11
2.3. Eport-E20-PIN Pins Definition	12
2.4. Electrical Characteristics	13
2.5. Ethernet Interface	13
2.6. Ethernet LED Interface	14
2.7. Eport-E20 Mechanical Size	14
2.8. Eport-E20-PIN Mechanical Size	14
2.9. Order Information	16
2.10. Evaluation Kits	16
2.11. Typical Application	17
3. FUNCTIONAL DESCRIPTION.....	19
3.1. Basic Network Protocol.....	19
3.2. Ethernet Interface Function	19
3.3. Typical Network Architecture	20
3.4. Working Mode	21
3.4.1 Transparent Transmission Mode.....	21
3.4.2 TCP Server	21
3.4.3 HTTP Mode.....	22
3.4.4 Telnetd Mode	24
3.5. AES/DES3/TLS Data Encryption.....	26
3.6. Keepalive	26
3.7. Timeout	27
3.8. Route Setup.....	27
3.9. UART Frame Scheme	28
3.10.1. UART Free-Frame	28
3.10.2. UART Auto-Frame.....	29
3.10.3. Tag Function	29
3.10. Modbus Protocol.....	30

3.11.	Cli Command	30
3.12.	UART Flow Control and RS485 Function	31
3.13.	Firmware Upgrade	32
3.14.	Web Page Function	32
3.15.	Auto-IP Function	33
3.16.	Other Function	34
3.17.	NTP Function	34
3.18.	Heartbeat Function	35
3.19.	UART Fast Config	35
4.	CLI COMMAND NOTES	36
4.1.	Working Mode	36
4.1.1.	Switch Transparent Transmission Mode to Cli Command Mode	36
4.2.	Cli Command Overview	37
4.2.1.	Cli Command Format	40
4.2.1.1.	Show Command.....	40
4.2.1.2.	SYS Directory	41
4.2.1.3.	SYS/Auth Directory	41
4.2.1.4.	SYS/Auth/User Command.....	41
4.2.1.5.	SYS/Auth/Password Command	42
4.2.1.6.	SYS/Network Directory.....	42
4.2.1.7.	SYS/Network/Show Command	42
4.2.1.8.	SYS/Network/DHCP Command	42
4.2.1.9.	SYS/Network/DNS Command	42
4.2.1.10.	SYS/Network/Hostname Instruction	43
4.2.1.11.	SYS/Telnet Instruction.....	43
4.2.1.12.	SYS/Web Instruction	43
4.2.1.13.	SYS/MAC Instruction.....	44
4.2.1.14.	SYS/JCMD Instruction.....	44
4.2.1.15.	SYS/NTP Instruction.....	44
4.2.1.16.	UART Directory	44
4.2.1.17.	UART/Show Instruction	45
4.2.1.18.	UART/Baudrate Instruction.....	45
4.2.1.19.	UART/Databits Instruction.....	45
4.2.1.20.	UART/Stopbits Instruction	45
4.2.1.21.	UART/Parity Instruction	46
4.2.1.22.	UART/Buf Directory	46
4.2.1.23.	UART/Buf/Bufsize Instruction	46
4.2.1.24.	UART/Buf/GapTime Instruction	46
4.2.1.25.	UART/Buf/FlowCtrl Command.....	47
4.2.1.26.	UART/Buf/SWFlowCtrl Command.....	47
4.2.1.27.	UART/Cli-Getin Command	47
4.2.1.28.	UART/Cli-WaitTime Command.....	48
4.2.1.29.	UART/Proto command	48
4.2.1.30.	UART/Frame Directory	48

4.2.1.31. UART/Frame/FrameLen Command	48
4.2.1.32. UART/Frame/FrameTime Command	49
4.2.1.33. UART/Frame/Tag Command.....	49
4.2.1.34. UART/Edit Command.....	49
4.2.1.35. UART/Clean Command.....	49
4.2.1.36. SOCK Directory	50
4.2.1.37. SOCK/Show Command.....	50
4.2.1.38. SOCK/New Command.....	50
4.2.1.39. SOCK/netp directory.....	52
4.2.1.40. SOCK/netp/clean Command	52
4.2.1.41. DATA Directory.....	52
4.2.1.42. Restart Command	52
4.2.1.43. Reload Instruction.....	53
4.2.1.44. Exit Command	53
4.2.1.45. Quit Command	53
4.2.1.46. FwUpgrade Instruction	53
APPENDIX A: HW REFERENCE DESIGN.....	54
APPENDIX B:REFERENCES	55
B.1. Test Tools	55
B.2. Application usage material	55
B.2. More materials.....	55
APPENDIX C:TELNET COMMUNICATION FUNCTION	56
C.1. Telnet Use Scene:	56
C.2. Telnet Features:	56
C.3. Telnet Usage:.....	56
APPENDIX D: CONTACT INFORMATION	60

LIST OF FIGURES

Figure 1.	Eport-E20 Appearance	10
Figure 2.	Eport-E20-PIN Appearance	10
Figure 3.	Eport-E20 Pins Map.....	11
Figure 4.	Eport-E20-PIN Pins Map.....	12
Figure 5.	Eport-E20 Mechanical Dimension.....	14
Figure 6.	Eport-E20 Mechanical Dimension.....	15
Figure 7.	Eport-E20-PIN recommended PCB layout.....	15
Figure 8.	Eport-E20 Product Number Defination	16
Figure 9.	Eport-E20 EVK	16
Figure 10.	Eport-E20 Hardware Typical Application	17
Figure 11.	Eport-E20 Software Protocol Structure	19
Figure 12.	Ethernet Interface Function.....	20
Figure 13.	Network application	20
Figure 14.	Transparent data transmission example	21
Figure 15.	TCP Server data transmission example	22
Figure 16.	Multi Socket data transmission example.....	22
Figure 17.	Webpage set up multi Socket channel.....	22
Figure 18.	IOTService Software Configure	23
Figure 19.	Web Page Configure	23
Figure 20.	HTTP transmit example	24
Figure 21.	IOTService Software Configure Protocol	25
Figure 22.	Web page configure protocol	25
Figure 23.	Telnet details example	26
Figure 24.	IOTService Software Configure Encryption	26
Figure 25.	Web Page Configure Encryption.....	26
Figure 26.	Web Page Config Keepalive	27
Figure 27.	Web Page Configure Timeout.....	27
Figure 28.	Route function setup example	28
Figure 29.	Route Function Data Flow Example	28
Figure 30.	UART free-frame function	29
Figure 31.	UART Auto-Frame Function	29
Figure 32.	UART Auto-Frame Function	29
Figure 33.	UART Auto-Frame Tag Function	30
Figure 34.	UART Modbus Function.....	30
Figure 35.	Cli Command Setting.....	30
Figure 36.	UART Flow Control.....	31
Figure 37.	UART Half Duplex Function.....	31
Figure 38.	RS485 Reference Schemetic.....	31
Figure 39.	External web page	32
Figure 40.	Internal web page	32
Figure 41.	Web Page Function Setting	32
Figure 42.	AUTO-IP Connection	33
Figure 43.	AUTO-IP Config Device	33

Figure 44.	Cli Command Query Device IP	33
Figure 45.	Other Function	34
Figure 46.	IOTService Tools NTP Setting.....	34
Figure 47.	Cli Command NTP Setting and Query	35
Figure 48.	Heartbeat Function	35
Figure 49.	Eport-E20 Default: UART Parameters	36
Figure 50.	Switch Transparent Transmission Mode to Cli Command Mode	37
Figure 51.	Cli Command Root Directory	37
Figure 52.	Cli Command SYS Tree.....	38
Figure 53.	Cli Command UART Tree	38
Figure 54.	Cli Command SOCK Tree.....	39
Figure 55.	Cli Other Command	40
Figure 56.	HW REFERENCE DESIGN.....	54

LIST OF TABLES

Table1.	Eport-E20 Series Module Technical Specifications	8
Table2.	Eport-E20 Pins Definition	11
Table3.	Eport-E20-PIN Pins Definition	12
Table4.	Absolute Maximum Ratings:	13
Table5.	Power Supply & Power Consumption:	13
Table6.	Ethernet Interface Definition	13
Table7.	LED Interface Definition.....	14
Table8.	Eport-E20 EVK Interface	17

HISTORY

Ed. V1.0	11-16-2017	First Version
Ed. V1.1	01-10-2018	Add Eport-E20-PIN, Update Eport-E20 size and appearance.

1. PRODUCT OVERVIEW

1.1. General Description

The Eport-E20 series is a fully self-contained small form-factor, most compact, integrated solution, which provide a serial interface to Ethernet connectivity to web enable any device. The Eport-E20 integrate TCP/IP controller, memory, 10/100M Ethernet transceiver, high-speed serial port within a compact RJ45 package and integrates a fully developed TCP/IP network stack and Linux OS. The Eport-E20 also includes an embedded web server used to remotely configure, monitor, or troubleshoot the attached device.

The Eport-E20 series using highly integrated hardware and software platform, It has been optimized for all kinds of applications in the industrial control, smart grid, personal medical application and remote control that have lower data rates, and transmit or receive data on an infrequent basis. By simply adding an Eport-E20 unit to a product Design, device manufacturers can reduce their Design cycle and speed up Time-To-Market with very low risk.

The Eport-E20 series integrates all serial to Ethernet functionality into a low-profile, 50 x 23 x 11mm standard RJ45 module package that can be easily mounted on main PCB with application specific circuits and even not change your original Design.

Eport-E20-PIN is Eport-E20 with PIN transformation board. The function is the same.

1.2. Device Parameters

Table1. Eport-E20 Series Module Technical Specifications

Item	Parameters
System Information	
Processor/Frequency	Cortex-M3/96MHz
Flash/SDRAM	2MB/128KB
Operating System	FreeRTOS
Ethernet Port	
Port Number	1 RJ45 with LED
Interface Standard	10/100 Base-T Auto-Negotiation
Protection	1.5KV Isolation
Transformer	Integrated
Network Protocol	IP, TCP, UDP, DHCP, DNS, HTTP Server/Client, ARP, BOOTP, AutoIP, ICMP, Web socket, Telnet, FTP, TFTP, uPNP, NTP, SNMP, Modbus TCP
Security Protocol	TLS AES 128Bit DES3
IPV6 Support	No
Serial Port	

Port Number	1 + 1 debug
Interface Standard	3.3V TTL: 2 wire (TX,RX)
Data Bits	5,6,7,8
Stop Bit	1,2
Check Bit	None,Even,Odd
Baud Rate	TTL: 6000 bps~921600bps
Flow Control	No Flow control Hardware RTS/CTS、DSR/DTR Software Xon/ Xoff flow control
Software	
Web Pages	Http Web Configuration Customization of HTTP Web Pages
Log	Remote Realtime Log,
Configuration	Web CLI XML import Telnet IOTService PC Software UART Fast Config
Firmware Upgrade	Web, IOTService
Basic Parameter	
Size	Eport-E20: 50 x 23 x 11 mm Eport-E20-PIN: 50 x 23 x 12mm
Operating Temp.	-45 ~ 85°C
Storage Temp.	-45 ~ 105°C, 5 ~ 95% RH (no condensation)
Input Voltage	3.3V
Working Current	~100mA
Power	<400mW
Other Information	
Certificate	CE, FCC, RoHS

1.3. Key Application

The Eport-E20 device connects serial device to Ethernet networks using the TCP/IP protocol:

- Remote equipment monitoring
- Asset tracking and telemetry
- Security Application
- Industrial sensors and controls
- Medical devices
- ATM machines
- Data collection devices
- Universal Power Supply (UPS) management units
- Telecommunications equipment
- Data display devices
- Handheld instruments
- Modems
- Time/attendance clocks and terminals

2. HARDWARE INTRODUCTION

The Eport-E20 series is a complete solution for serial port device connecting to network. Packaged into a RJ45 connector, this powerful device supports a 10/100BASE-T Ethernet connection, a reliable and proven operating system stored in flash memory, an embedded web server, a full TCP/IP protocol stack, and standards-based (AES) encryption.

Through Ethernet cable connect router with Eport –E20 serial server for data transfer, which makes the electromechanical integration very simple. Eport-E20 meet EMC Class B security level, It can pass every countries relevant certification test

2.1. Appearance

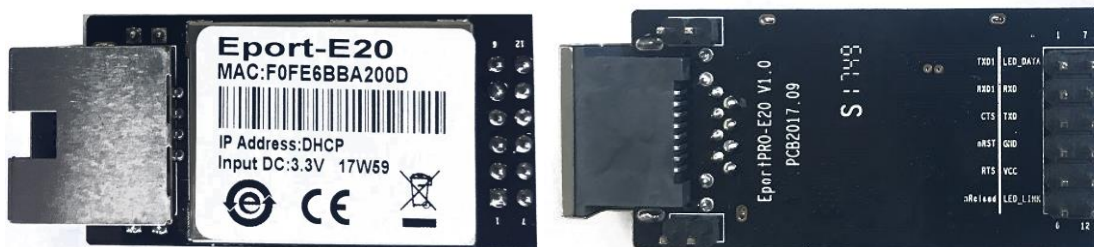

Figure 1. Eport-E20 Appearance

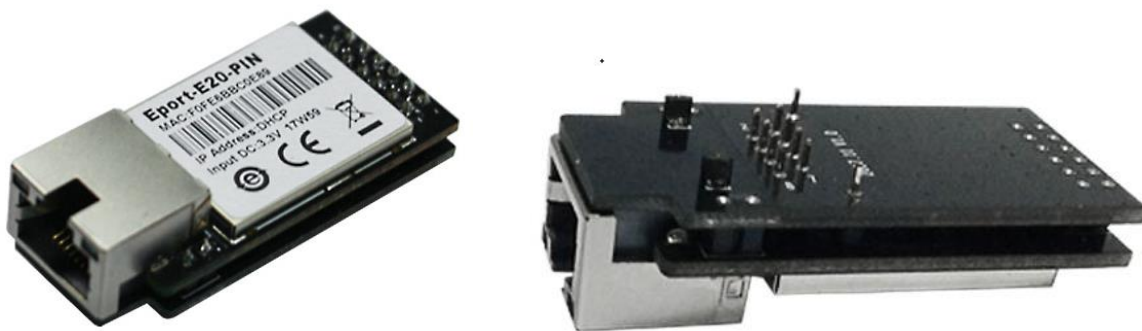

Figure 2. Eport-E20-PIN Appearance

2.2. Eport-E20 Pins Definition



Figure 3. Eport-E20 Pins Map

Table2. Eport-E20 Pins Definition

Pin	DES3cription	Net Name	Signal Type	Comments
1	GPIO	GPIO1	I/O	Can be configured to UART1:TXD2
2	GPIO	GPIO2	I/O	Can be configured to UART1:RXD2
3	UART0	CTS	O	Can be configured to GPIO
4	External Reset In	nRST	I, PU	“Low” effective reset input.
5	UART0	RTS	I	Can be configured as RS485 control pin
6	Multi-Function Pin	nReload	I,PU	Detailed functions see <Notes>
7	LED indicator	LED2_Data	O	Detailed functions see <Notes>
8	UART0	RXD	I	3.3V, TTL.
9	UART0	TXD	O	3.3V, TTL.
10	Ground	GND	GND	Power Ground
11	+3.3V Power	DVDD	Power	+3.3V
12	LED indicator	LED1_Link	O	Detailed functions see <Notes>
EGND	EGND	EGND	EGND	Earth GND, Used to shield EMC signal. Connect to Ethernet Metal Shell Internally. It is not allowed to connect to GND.

<Notes>

nReload Pin function:

1. Put this pin low before the device powered on (or Reset), This device works in mass production mode to upgrade its firmware, this mode is used for upgrade customized firmware. The corresponding PC tools can be download on High Flying website.
2. After device is powered up, If put this pin to low more than 3 seconds and then put to High, It will restore the product parameters to factory setting.

We strongly suggest user to fan out this pin.

LED2_Data Pin

1. When there are data transmitting and receiving, This LED will flashing. If there is no data transmit and receive, It will output High.

LED1_Link Pin

1. When Ethernet connected normal, It will output Low, If there is no Ethernet connection, It will output High.

2.3. Eport-E20-PIN Pins Definition



Figure 4. Eport-E20-PIN Pins Map

Table3. Eport-E20-PIN Pins Definition

Pin	Description	Net Name	Signal Type	Comments
1	Ground	GND	GND	Power Ground
2	Ground	GND	GND	Power Ground
3	External Reset In	nRST	I, PU	"Low" effective reset input.
4	UART0	TXD	O	3.3V, TTL.
5	UART0	RXD	I	3.3V, TTL.
6	UART0	RTS	I	Can be configured as RS485 control pin
7	Multi-Function Pin	nReload	I,PU	Detailed functions see <Notes>
8	UART0	CTS	O	Can be configured to GPIO
EGND	EGND	EGND	EGND	Earth GND, Used to shield EMC signal. Connect to Ethernet Metal Shell Internally. It is not allowed to connect to GND.

<Notes>

nReload Pin function: Same as above.

2.4. Electrical Characteristics

Table4. Absolute Maximum Ratings:

Parameter	Condition	Min.	Typ.	Max.	Unit
Storage Temperature Range		-45		125	°C
Maximum Soldering Temperature	IPC/JEDEC J-STD-020			260	°C
Supply Voltage		0		3.8	V
Voltage on any I/O pin		0		3.3	V
ESD (Human Body Model HBM)	TAMB=25°C			2	KV
ESD (Charged Device Model, CDM)	TAMB=25°C			1	KV

Table5. Power Supply & Power Consumption:

Parameter	Condition	Min.	Typ.	Max.	Unit
Operating Supply Voltage		3.0	3.3	3.6	V
Operating Temperature Range		-45		85	°C
Supply Current (10BASE-T activity)@ 96MHz	Without data transmit and receive		40		mA
Supply Current (100BASE-T activity)@ 96MHz	5KB/S data		140		mA
Input Leakage Current	Ii	-10		10	uA
Output high voltage	@IOH=2mA	2.8			V
Output Low Voltage	@IOL=2mA			0.3	V
Input High Voltage		1.6		3.6	V
Input Low Voltage		-0.3		1.4	V
GPIO Input pull-up resistor			200		kΩ
GPIO Input pull-down resistor			200		kΩ

2.5. Ethernet Interface

The 10/100 Ethernet magnetics, network status LEDs, and RJ45 connector are all integrated into the Eport-E20 unit.

Table6. Ethernet Interface Definition

Pin	Description	Net Name	Signal Type
1	Transmit Data +	TX+	O
2	Transmit Data -	TX-	O
3	Receive Data +	RX+	I
4	NC		
5	NC		
6	Receive Data -	RX-	I
7	NC		
8	NC		
9	Case Ground	SHIELD	

2.6. Ethernet LED Interface

The device contains two bi-color Ethernet LED indicator (Detailed position is in dimension drawing .)

Table7. LED Interface Definition

Link LED (Left Side)		Activity LED (Right Side)	
Color	Meaning	Color	Meaning
Off	No Connection	Off	No Data
Yellow	10/100Mbps	Green	Have Data

2.7. Eport-E20 Mechanical Size

The dimensions of Eport-E20 are defined as following picture (mm):

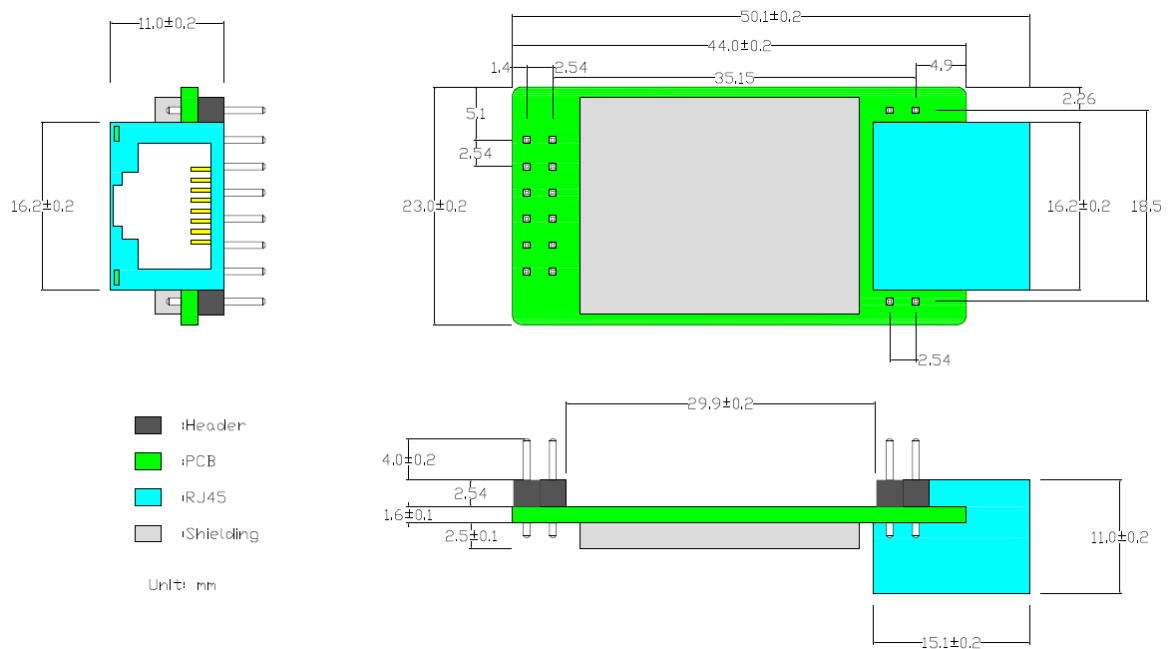

Figure 5. Eport-E20 Mechanical Dimension

2.8. Eport-E20-PIN Mechanical Size

The dimensions of Eport-E20-PIN are defined as following picture (mm):

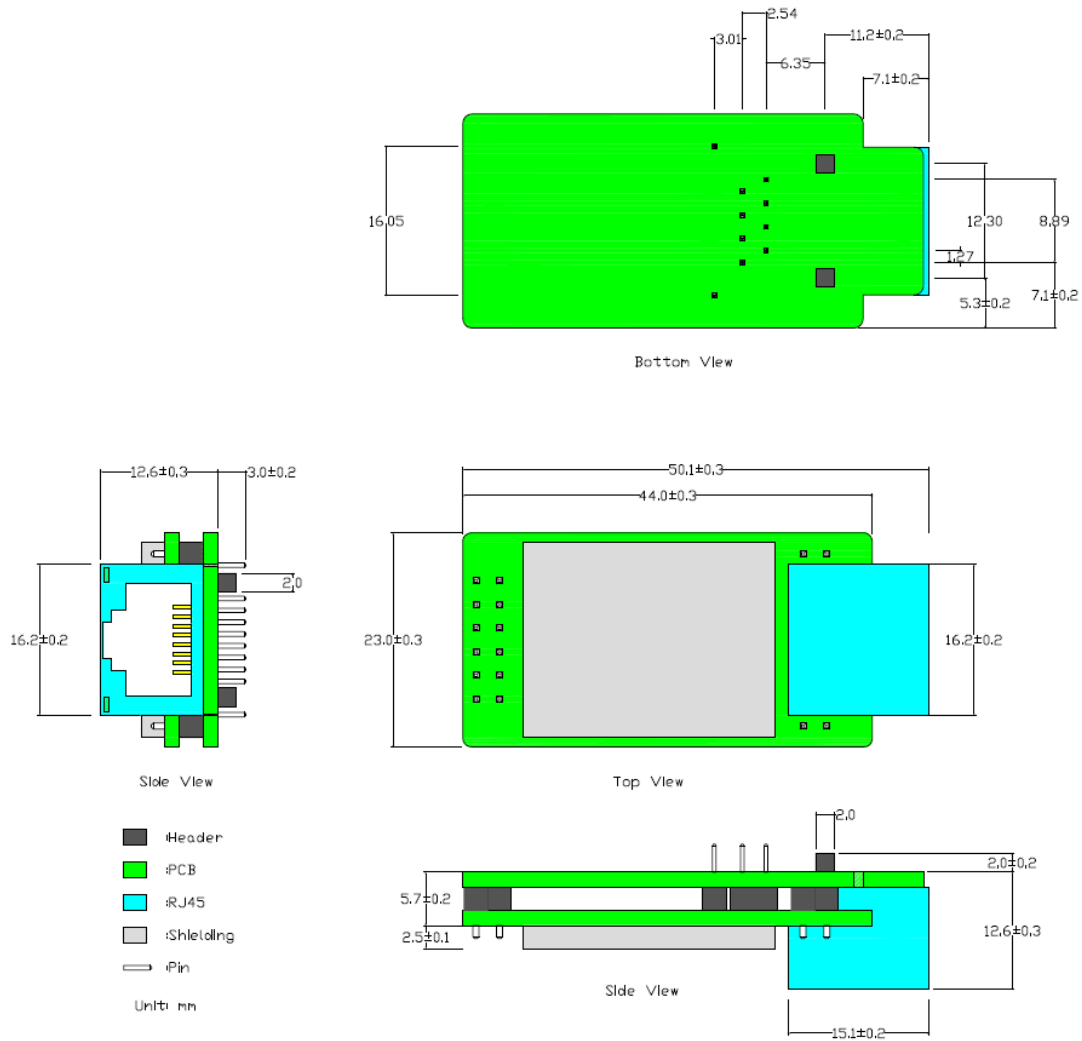

Figure 6. Eport-E20 Mechanical Dimension

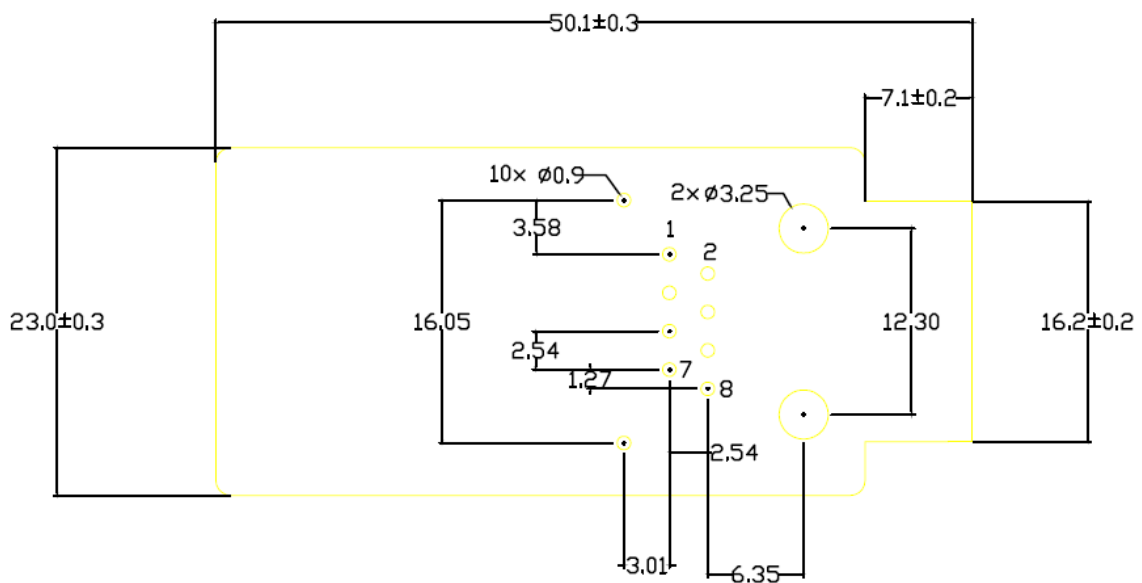

Figure 7. Eport-E20-PIN recommended PCB layout

2.9. Order Information

Base on customer detailed requirement, Eport-E20 provide different configuration version, Details as below:

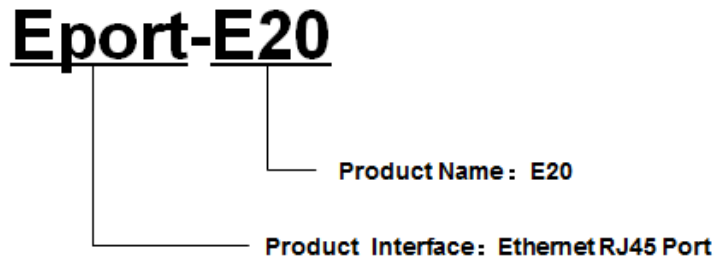

Figure 8. Eport-E20 Product Number Defination

2.10. Evaluation Kits

We provide evaluation kit for user to learn to use Eport-E20(Eport-E20-PIN is the same as Eport-E20, so for evaluation, juse use Eport-E20). Evaluation kit picture is as following, User can use RS232, USB Serial or Ethernet interface to configure parameters, manage equipment and do some function test. (onboard FT232R chip switch, its driver can be download from high flying website, When using USB Serial, the top right corner jumper need to all jump to the left side). .

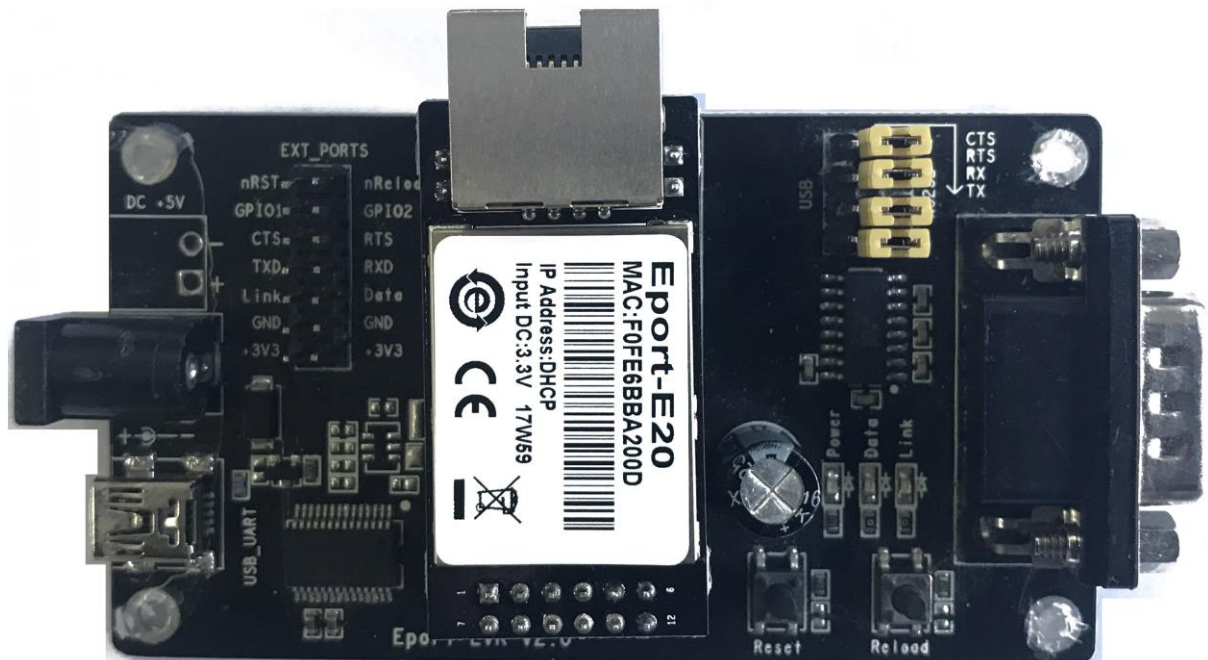

Figure 9. Eport-E20 EVK

Evaluation kit interface details as following:

Table8. Eport-E20 EVK Interface

Function	Name	Describe
External Interface	COM	Main data/command RS-232 interface
	USB_UART	UART to USB debug interface (Used for PC debug envirement which without RS232 interface, Need load drivers to use) , Can be power supply port
	DC5	DC 5V input
	EXT PORT	GPIO Pin interface
	JMP	4Pin USB or RS232 jumper. All jump to left choose USB Serial.. All jump to right choose RS232
LED	Power	3.3V Power Indicate
	Link	Network indicator, Detailed functions see LED1_Link Pin<Notes>
	Data	Communication indicator, Detailed functions see LED2_Data Pin<Notes>
Button	Reset	"Reset" Button
	Reload	Press down the button more than 3s and then loose to restore factory setting

2.11. Typical Application

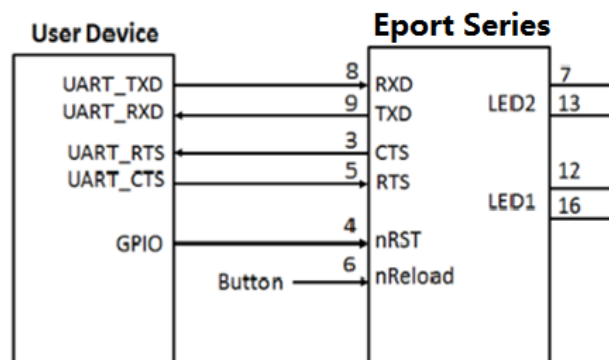

Figure 10. Eport-E20 Hardware Typical Application

Notes:

nRST- Input.Hardware reset signal. Effective Low.

There is internal pull-up resistor to 3.3V and no external pull-up resistor needed. MCU put nRST signal to low for at least 10ms if need to reset the device.

nReload- Input.Device restore to factory default configuration. Effective Low; (**Recommend this pin to connect button or jumper header, Used for batch upgrade and configuration**)

Can connect with external button or chip pin, When press nReload button, pull the pin to Low level more than 3s, then loose, device will restore to factory default setting and restart itself. If nReload function is not required, Can leave this pin open, Don't need any connection.

TXD/RXD- UART port data transmit and receive signal.

3. FUNCTIONAL DESCRIPTION

The Eport-E20 has the following feature:

- Connect customer’s device with PC or server via TCP/UDP/Telnet.
- Contain a HTTP web server allow user to configure through browser with PC or phone.
- Have multi-programmable I/O pins used to monitor or control device directly.

3.1. Basic Network Protocol

The Eport-E20 device uses the IP address for network communications. If uses the TCP to assure that no data is lost or duplicated. If use UDP to assure that data can be fast and effective to destination address. (The following take E20picture as example)

Supported protocols include:

- ARP, UDP, TCP, ICMP, DHCP, Telnet, DHCP, HTTP Server/Client Web socket
- Telnet command configuration, Web server configuration
- Security Protocol: TLS/TLS, AES, DES3 encryption

Eport –E20				
Application Programming Interface	Protocols		Security	Configuration
	DHCP	DNS/DDNS	TLS/TLS	Web
	IGMP	TCP/IP	AES	CLI
	WebSocket	HTTP	DES	Telnet
	TCP/UDP			Log
	IP/ICMP			
Ethernet				
FreeRTOS OS			Drivers	
Cortex-M3 MCU				

Figure 11. Eport-E20 Software Protocol Structure

3.2. Ethernet Interface Function



Figure 12. Ethernet Interface Function

The Eport-E20 device Ethernet interface work in WANN function by default. When connect to router, it will get IP address from router(as picture 192.168.1.100). Then the device and the PC1 are in the same local area network(LAN) for network communication, The data of communication finally pass from UART to network to control or collect PLC device.

Notes:

The device UART is TTL Level voltage. If connect to RS232 interface device, Need to add the external chip to transfer TTL UART to RS232 UART.

3.3. Typical Network Architecture

As the following picture, Eport-E20 and mobile device all connect to the same Router AP. At the same time, Eport-E20 connect to user equipment by RS232 interface(RS485 function can be customized to support, still need additional 485 chip). The whole wireless network is easily to extend in this kind of network structure.

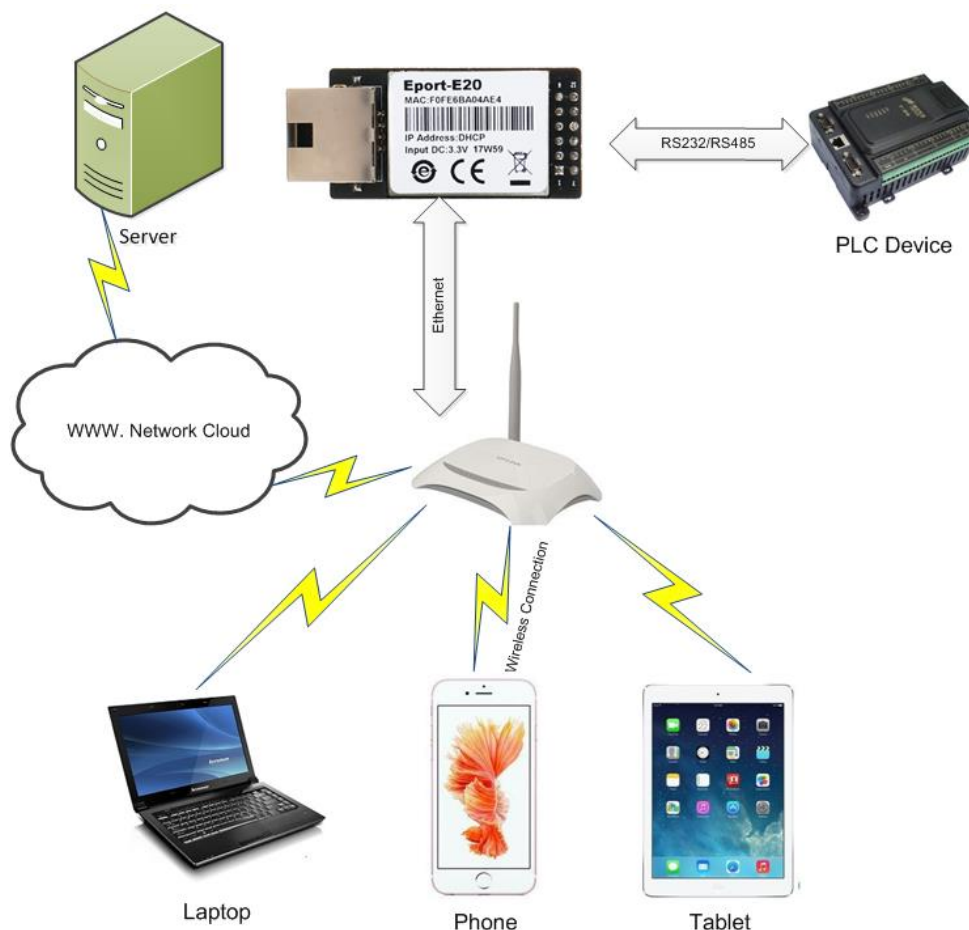

Figure 13. Network application

3.4. Working Mode

3.4.1 Transparent Transmission Mode

The Eport-E20 Device support transparent transmission mode of serial interface, In this mode, User only need to set some necessary parameter(network communication parameter). After power on, the device can auto connect to default socket setting(TCP/UDP). Use web page or PC IOTService software to set commucation parameter.

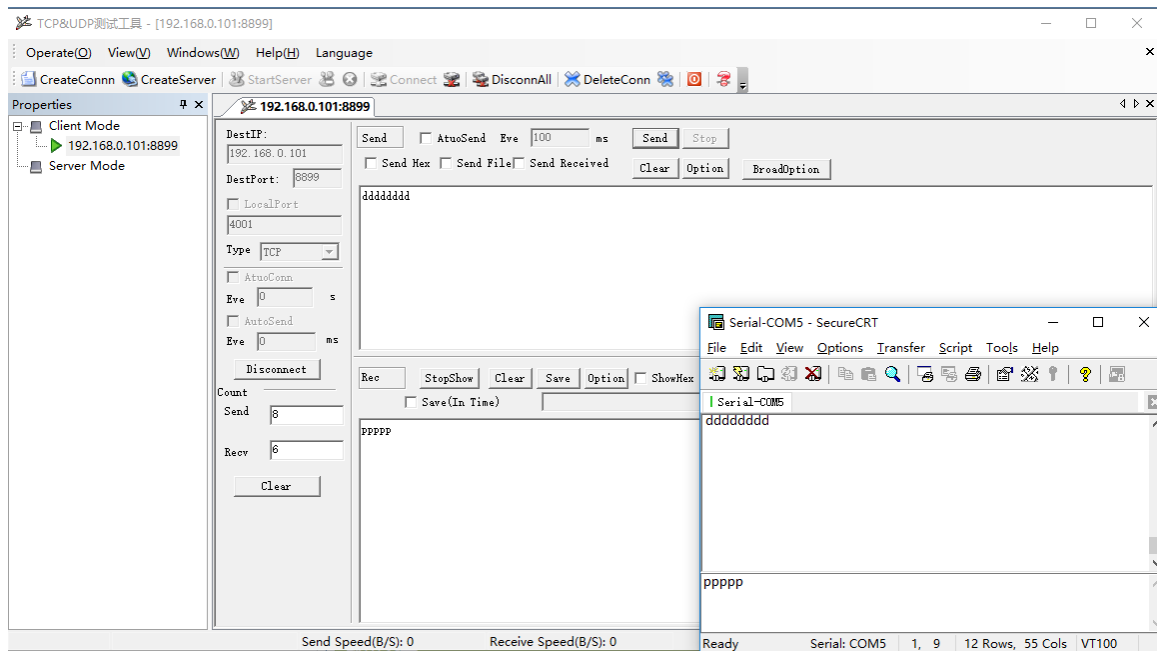

Figure 14. Transparent data transmission example

3.4.2 TCP Server

Transparent transmission mode support TCP Server、TCP Client、UDP Server、UDP Client communication application, UDP Server is special function, Details see following Cli instruction. There is a default tcp server socket created. The Socket can be modified to work at one of the above working mode. When Socket works as TCP server, It will support multiple TCP connection(max 5 TCP client). Multiple TCP connection will work in below structure:

Upload data flow: All the different TCP connection or the Client's data will be continuously transmitter to UART.

Download data flow: All data received from UART will be copied and broadcast to every TCP client.

Detailed multiple TCP connection structure drawing as below:

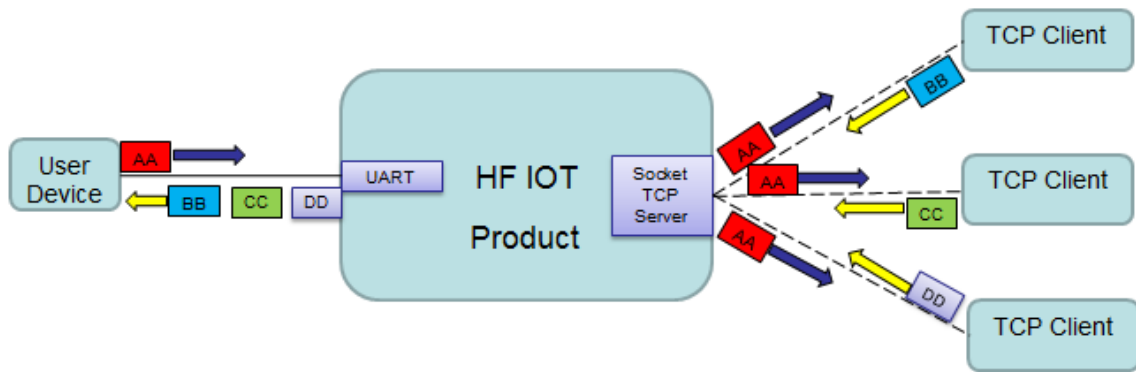

Figure 15. TCP Server data transmission example

The device support max 5 Socket channel, each socket can work individual at TCP/UDP, Multi Socket simultaneous communication of data stream is as following.

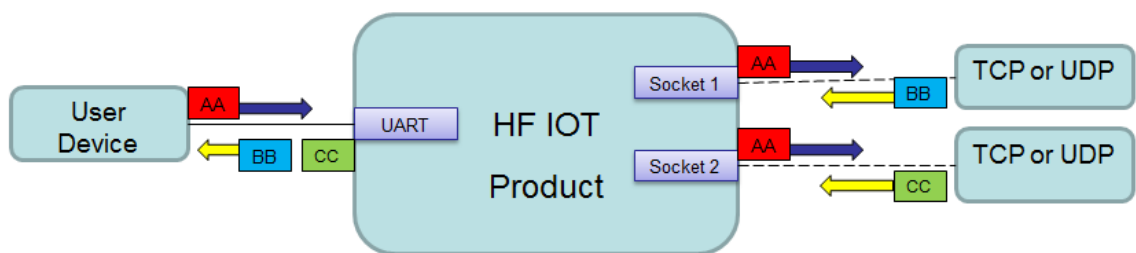

Figure 16. Multi Socket data transmission example

Multi Socket can be created through software configure or webpage configure. The below set up 3 socket channel.

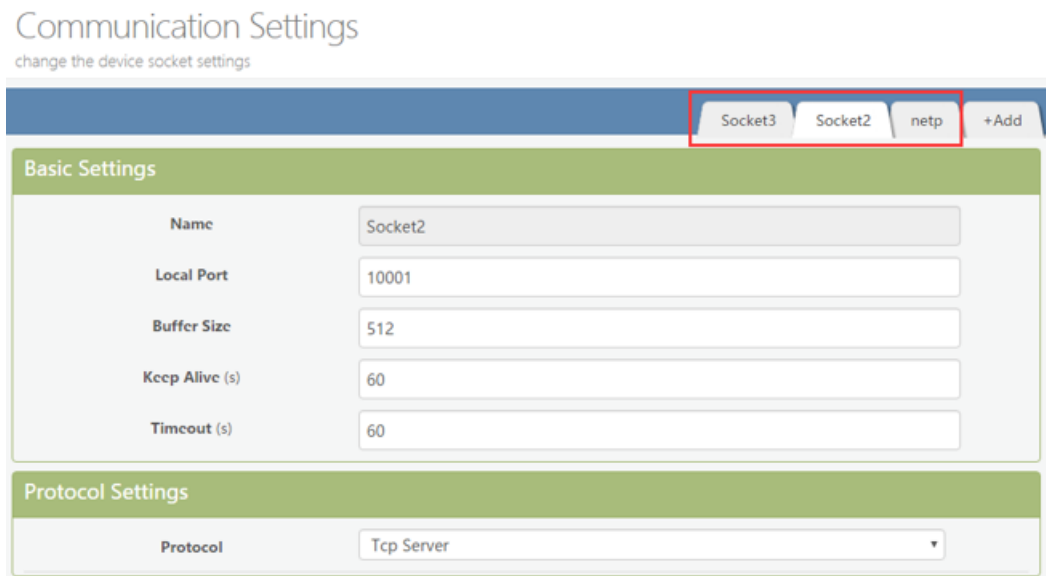

Figure 17. Webpage set up multi Socket channel

3.4.3 HTTP Mode

Eport -E20 device support sending data in HTTP format to HTTP server(Set product working mode by IOTService software or webpage). When device socket works in HTTP mode, All received UART data will automaticly transform to HTTP format(add HTTP header) and transmit to HTTP server. For the received HTTP data from HTTP server, will automaticly remove HTTP header and only output the data packet to UART.

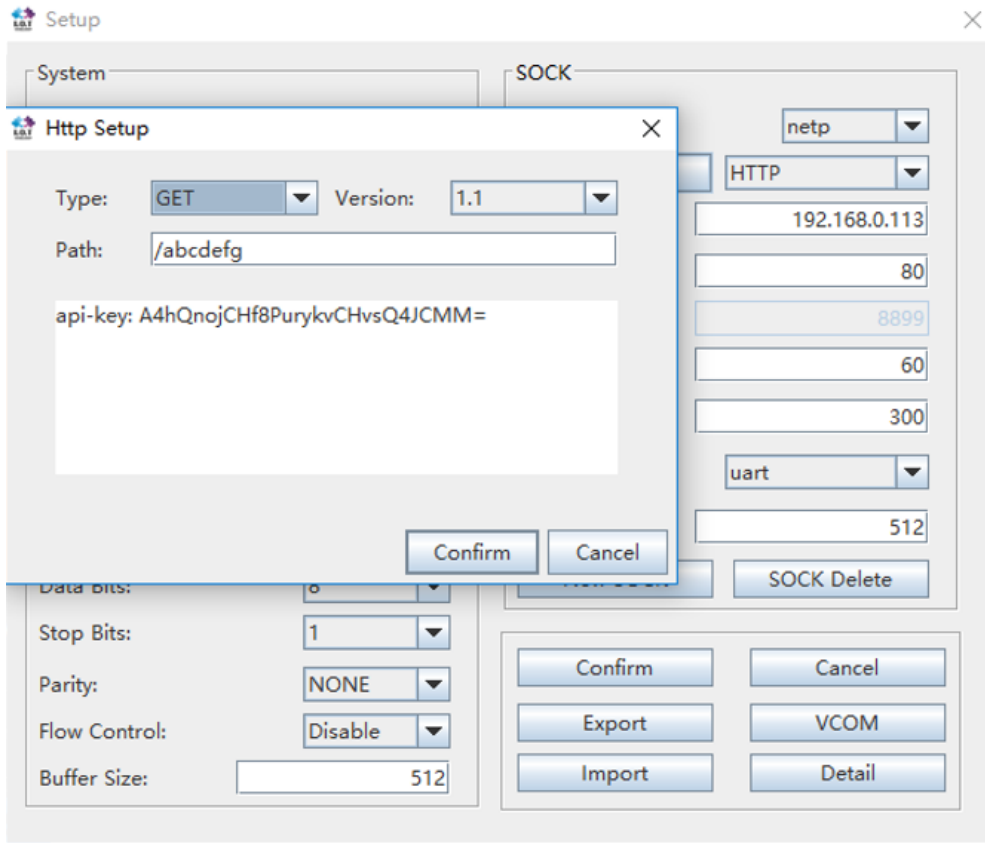

Figure 18. IOTService Software Configure

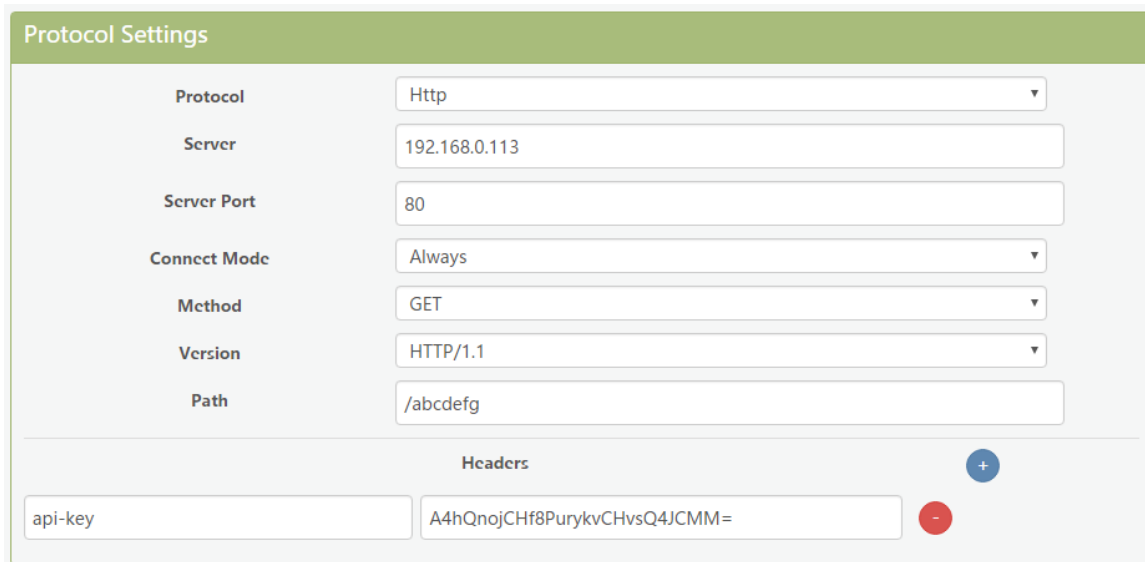

Figure 19. Web Page Configure

Eport-E20 UART received“pppp”data, send below data to HTTP Server.

GET /abcdefg HTTP/1.1

api-key: A4hQnojCHf8PurykvCHvsQ4JCMM=

pppp

HTTP Server send below data, Eport-E20 serial output“abcde”

GET /abcdefg HTTP/1.1

api-key: A4hQnojCHf8PurykvCHvsQ4JCMM=

abcde

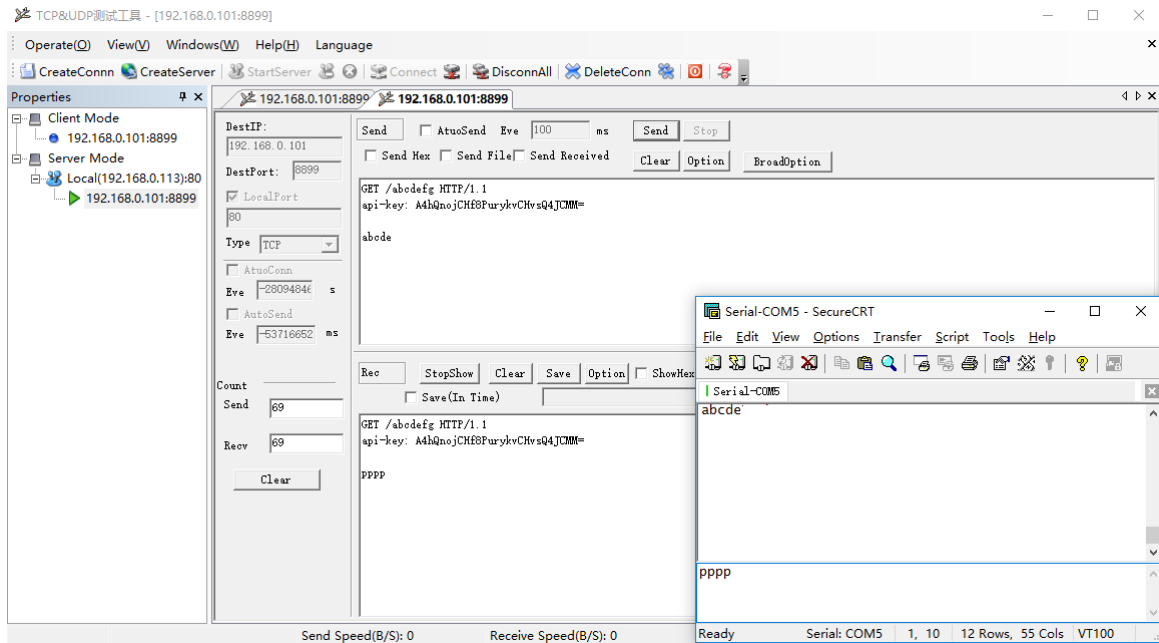

Figure 20. HTTP transmit example

3.4.4 Telnetd Mode

When device work in Telnetd mode, UART port can connect to user device console port(some gateway and switch device may have this console port to set parameters of its working mode). May use Eport-E20 to config user device via Telnetd mode.

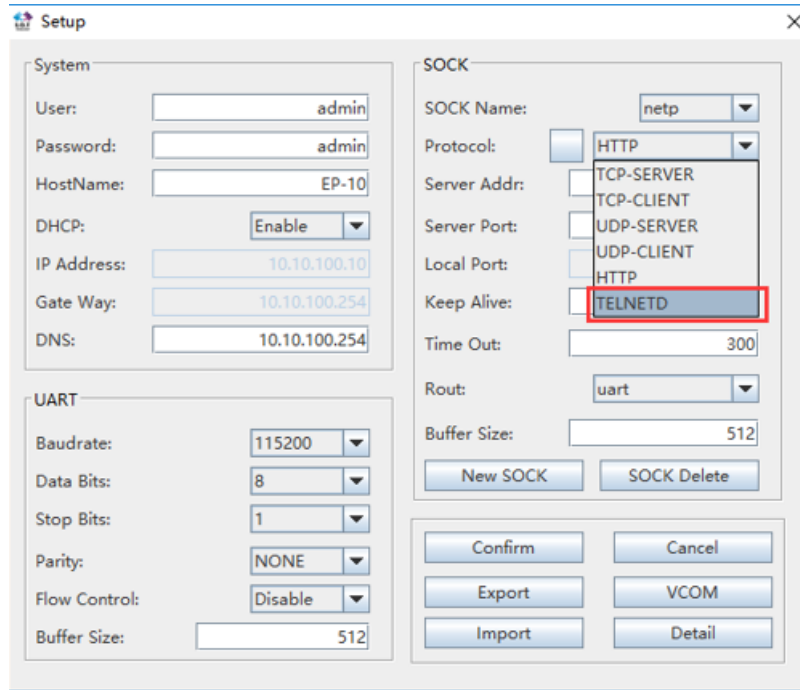

Figure 21. IOTService Software Configure Protocol

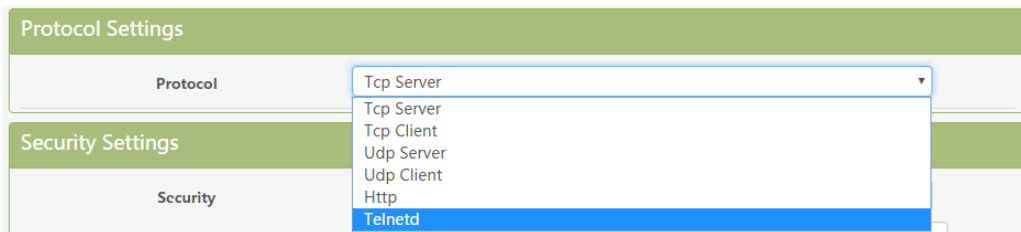

Figure 22. Web page configure protocol

Connect device UART to user device console port(The example use NC916) and create Telnet connection. Then It can directly configure user device.

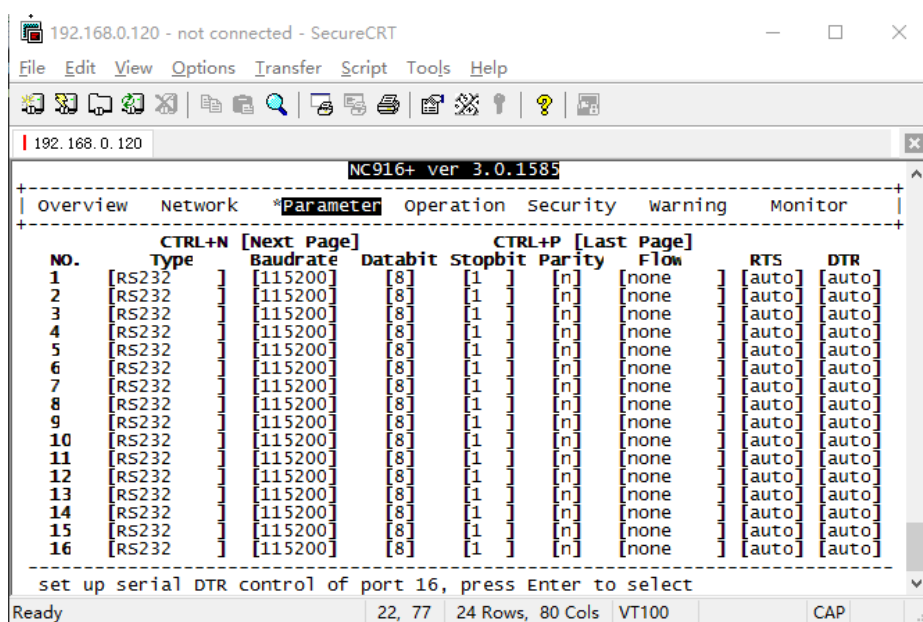
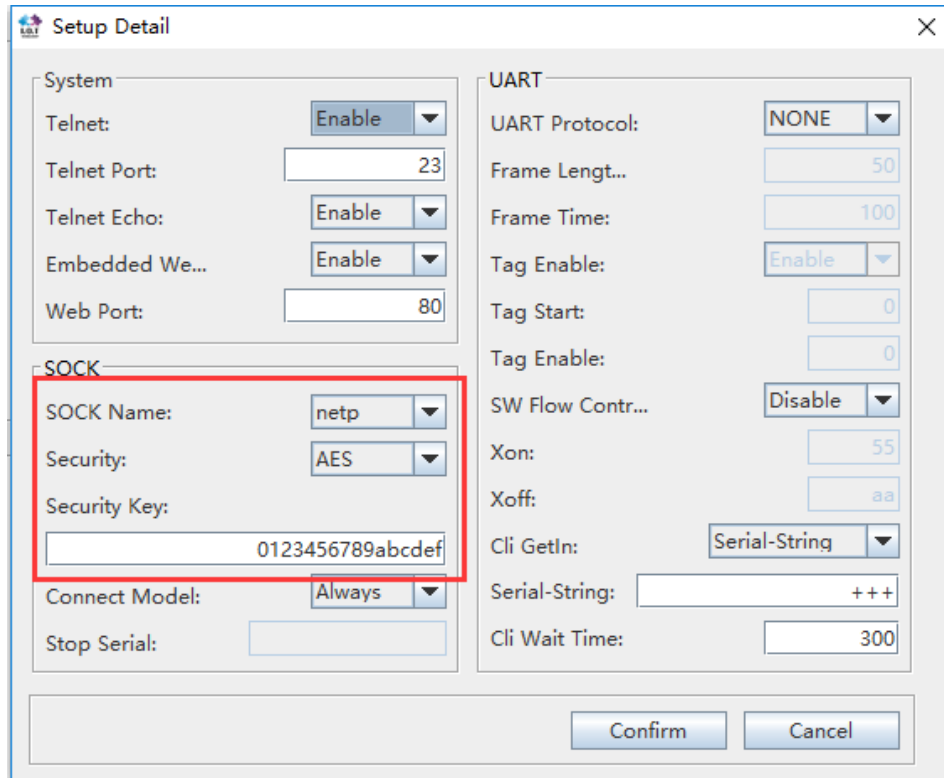

Figure 23. Telnet details example

3.5. AES/DES3/TLS Data Encryption

To improve device security and ensure the data won't be cracked and illegal used, The Eport-E20 device can do encryption to UART data before transmit to network.



The screenshot shows the 'Setup Detail' dialog box with the following configuration:

- System:**
 - Telnet: Enable
 - Telnet Port: 23
 - Telnet Echo: Enable
 - Embedded We...: Enable
 - Web Port: 80
- SOCK (highlighted):**
 - SOCK Name: netp
 - Security: AES
 - Security Key: 0123456789abcdef
 - Connect Model: Always
 - Stop Serial: (empty)
- UART:**
 - UART Protocol: NONE
 - Frame Length...: 50
 - Frame Time: 100
 - Tag Enable: Enable
 - Tag Start: 0
 - Tag Enable: 0
 - SW Flow Contr...: Disable
 - Xon: 55
 - Xoff: aa
 - Cli GetIn: Serial-String
 - Serial-String: +++
 - Cli Wait Time: 300

Buttons: Confirm, Cancel

Figure 24. IOTService Software Configure Encryption

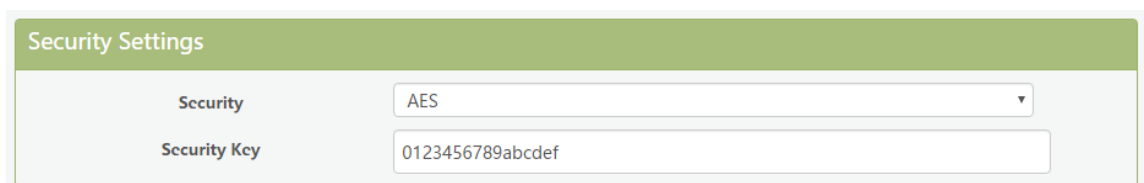

The screenshot shows the 'Security Settings' web page with the following configuration:

- Security: AES
- Security Key: 0123456789abcdef

Figure 25. Web Page Configure Encryption

3.6. Keepalive

When TCP connection between device and server became abnormal. The device will check the abnormal status and reconnect to server (when the device working in TCP Client Mode), When the device working in TCP Server, It will break the TCP client and wait for next connection.

Communication Settings

change the device socket settings

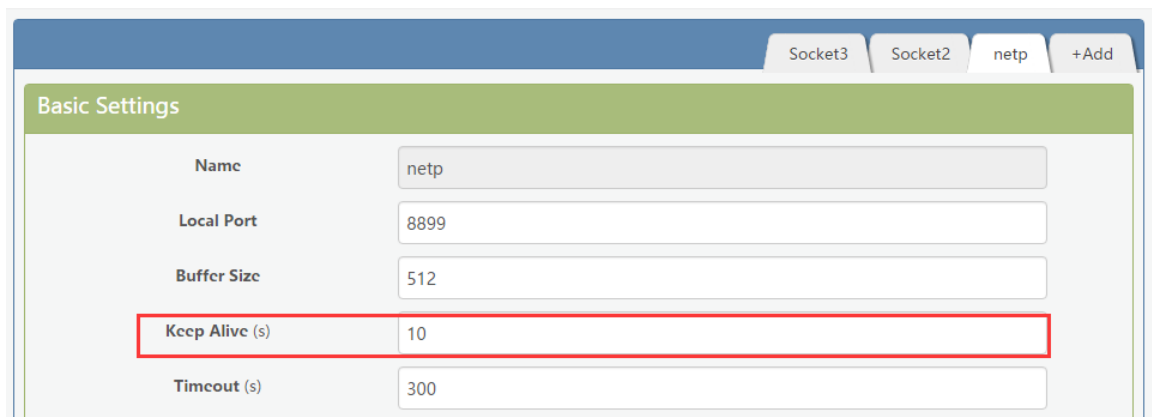

Basic Settings	
Name	netp
Local Port	8899
Buffer Size	512
Keep Alive (s)	10
Timeout (s)	300

Figure 26. Web Page Config Keepalive

3.7. Timeout

The device will break the TCP connection after some time(default is 300 seconds and it can be modified)if there is no data packet received from Destination TCP target . It will reconnect to server(When device works in TCP Client mode). When device working in TCP Server, It will disconnect with TCP Clie. This mechanism can effectively restore TCP abnormal connection.If set it to “0”, this function will be close.

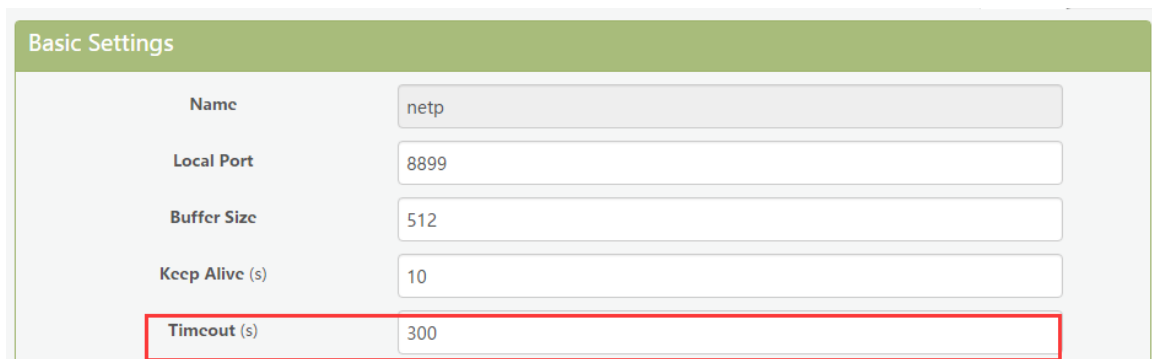

Basic Settings	
Name	netp
Local Port	8899
Buffer Size	512
Keep Alive (s)	10
Timeout (s)	300

Figure 27. Web Page Configure Timeout

3.8. Route Setup

The data received from Socket channel can be set to another socket channel. (Default: socket Destination channel is UART, It also can be other Socket channel, Or take the Socket as log print usage)

The below example shows the default netp Socket channel route setting to Socket1, Socket1 configure as TCP Server mode and route setting to UART. So the netp Socket channel received UART data will output to Socket1, and Socket1 channel will output to serial output.

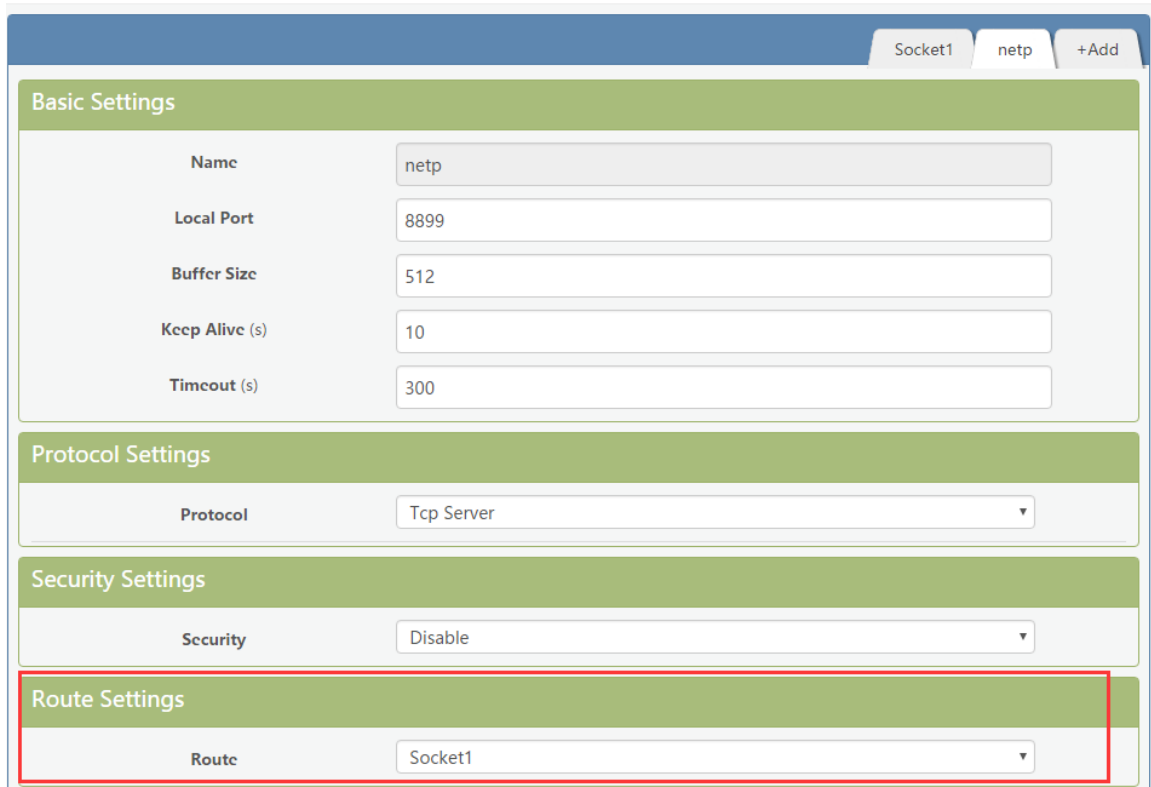

The screenshot shows the configuration interface for a 'netp' service. It is divided into four sections: Basic Settings, Protocol Settings, Security Settings, and Route Settings. The 'Route Settings' section is highlighted with a red border and shows 'Socket1' selected in the 'Route' dropdown menu.

Basic Settings	
Name	netp
Local Port	8899
Buffer Size	512
Keep Alive (s)	10
Timeout (s)	300

Protocol Settings	
Protocol	Tcp Server

Security Settings	
Security	Disable

Route Settings	
Route	Socket1

Figure 28. Route function setup example

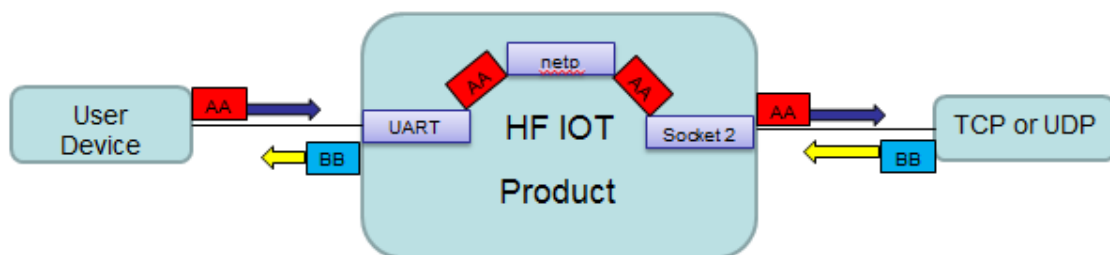

Figure 29. Route Function Data Flow Example

3.9. UART Frame Scheme

3.10.1. UART Free-Frame

Eport-E20 support UART Free-Frame function, If user select to open this function, Module will check the intervals between any two bytes when receiving UART data, If the interval time exceed the setting value, It will think it as the end of one frame, Or it will receive data till greater than internal buffer bytes(Default: 512, the largest 1400 bytes), then transfer to Socket Channel.

Module default UART Free-Frame interval time is 50ms, it will packaged into another frame if received UART data interval time is greater than 50ms. User also can set this interval time to minimum 10ms through Cli command and webpage.

If interval time is set to 10ms and customer MCU can't send next byte within 10ms, The serial data will be break into two frame.

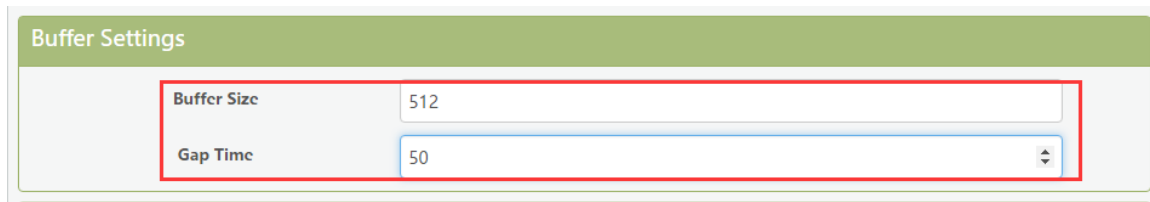

Figure 30. UART free-frame function

3.10.2. UART Auto-Frame

Eport-E20 support UART Auto-Frame function, If user select to open this function, setting frame trigger length and auto frame trigger time parameters, Then the product will auto framing the data which received from UART port and transmitting to the network as pre-defined data structure.

Auto-Frame trigger length: The fixed data length that product used to transmitting to the network.

Auto-Frame trigger time: After the trigger time, If UART port received data can't reach auto-frame trigger length, Then product will transmitting available data to network and bypass the auto-frame trigger length condition.

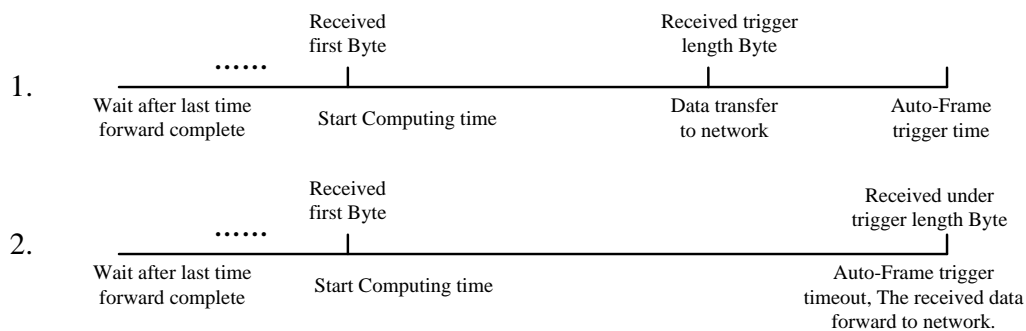

Figure 31. UART Auto-Frame Function

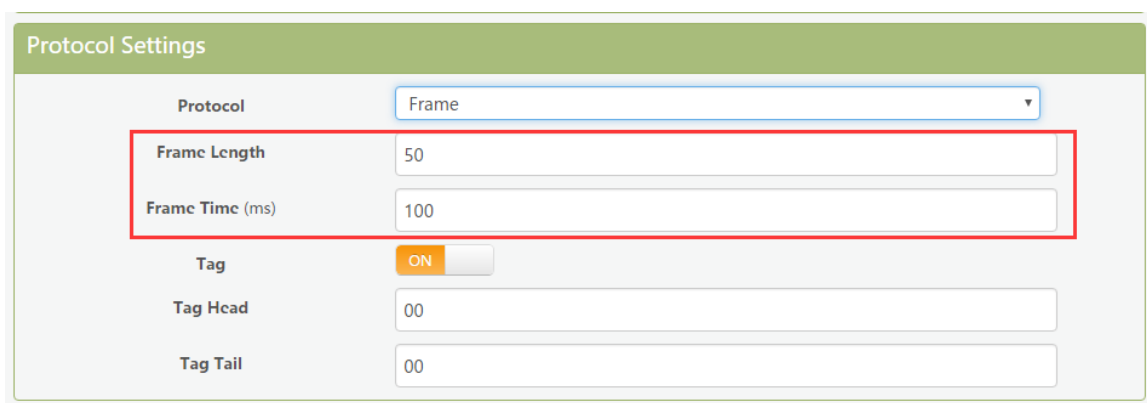
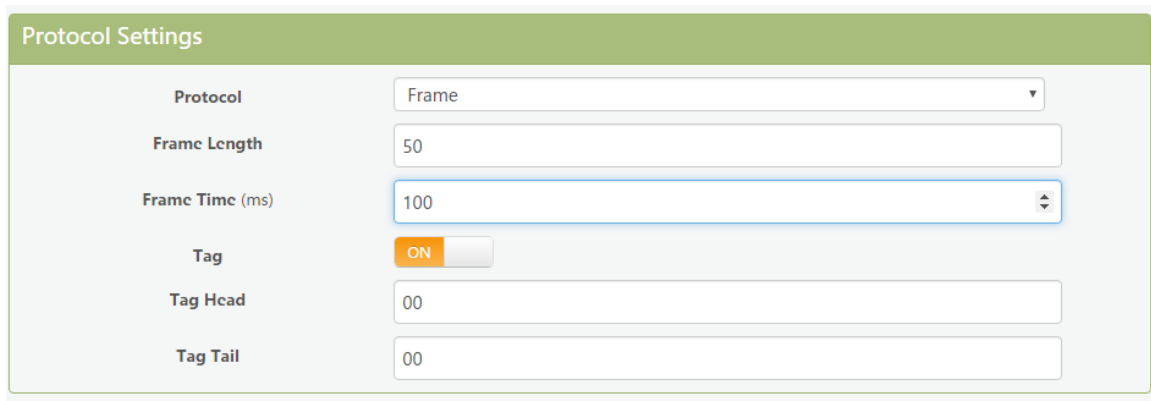

Figure 32. UART Auto-Frame Function

3.10.3. Tag Function

Eport E20 support lable function, If user select to open this function, The UART port will send all suitable one frame data to network.



The image shows a 'Protocol Settings' window with the following fields:

Protocol	Frame
Frame Length	50
Frame Time (ms)	100
Tag	ON
Tag Head	00
Tag Tail	00

Figure 33. UART Auto-Frame Tag Function

3.10. Modbus Protocol

Eport-E20 support ModbusRTU to ModbusTCP and ModbusTCP to ModbusRTU. It's very convenient to connect with Modbus device. Modbus protocol setting as below:

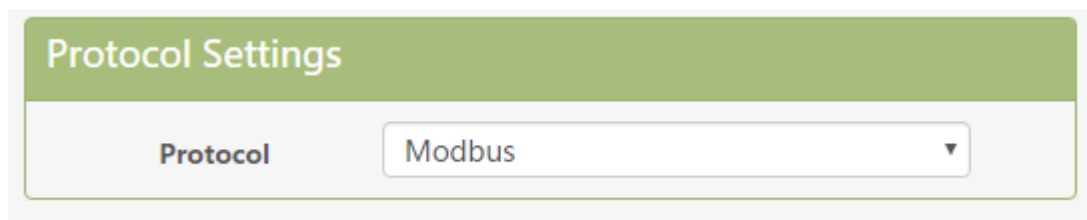

The image shows a 'Protocol Settings' window with the following field:

Protocol	Modbus
----------	--------

Figure 34. UART Modbus Function

3.11. Cli Command

Cli command is used for setting module configure parameters. Detailed command function and setting is in next chapter, Cli command can be set through UART port or Telnet function (Appendix C), The waiting time of below picture means use timeout time. If it exceed default 300s when no Cli command is input, it will exit Cli command mode. When the Eport-E20 receive continuous UART data of “+++”, it will enter into Cli command. (The device working in transparent transmission mode by default) May also set the device working in Cli command mode by default or disable this function .

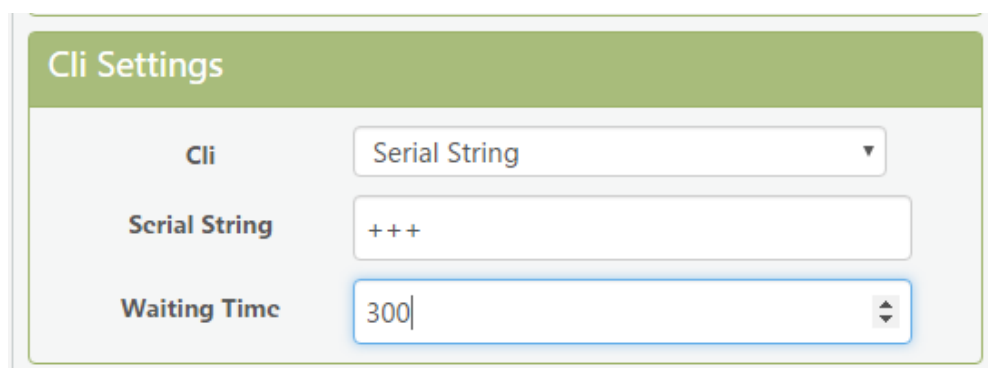

The image shows a 'Cli Settings' window with the following fields:

Cli	Serial String
Serial String	+++
Waiting Time	300

Figure 35. Cli Command Setting

3.12. UART Flow Control and RS485 Function

Eport-E20 support software and hardware UART flow control. If use hardware follow control, CTS/RTS Pin are used to control UART data. If use software follow control, then It allowed the device output UART data after receive single UART 0x11 data(Default: value can be modified). It will stop output UART data after receive single UART 0x13 data(Default: value can be modified).

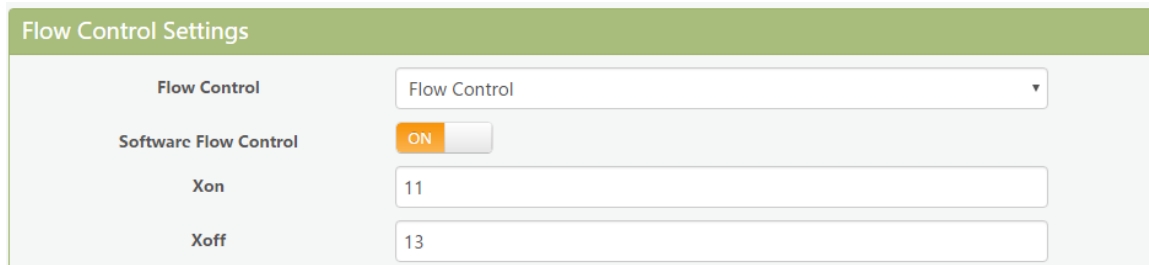

Figure 36. UART Flow Control

If set to “Half Duplex”, UART0_RTS pin is used for RS485 control.

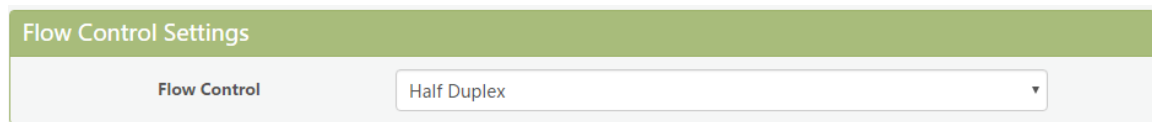

Figure 37. UART Half Duplex Function

RS485 reference schematic is as following.

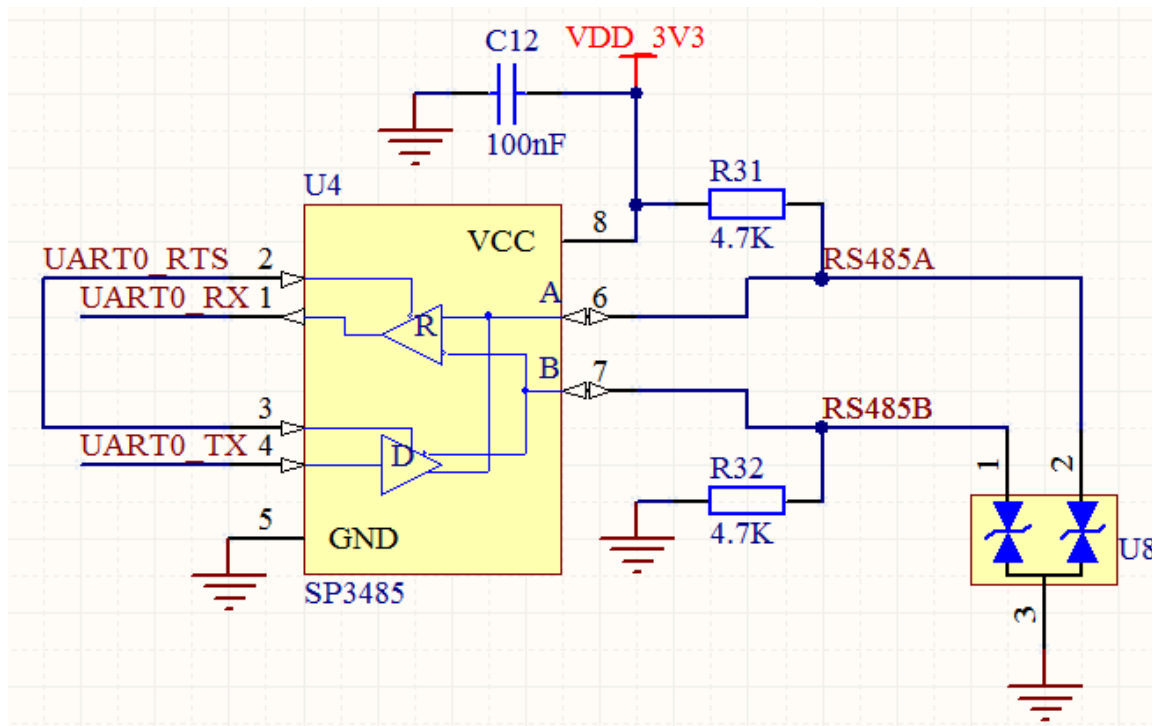

Figure 38. RS485 Reference Schematic

3.13. Firmware Upgrade

Eport-E20 support OTA(over the air) firmware upgrade. User can use webpage to upgrade its firmware, whether external or internal webpage(192.168.0.101/hide. Internal webpage can be used for upgrade external webpage). Please check below example. IP address is assigned by router.



Figure 39. External web page

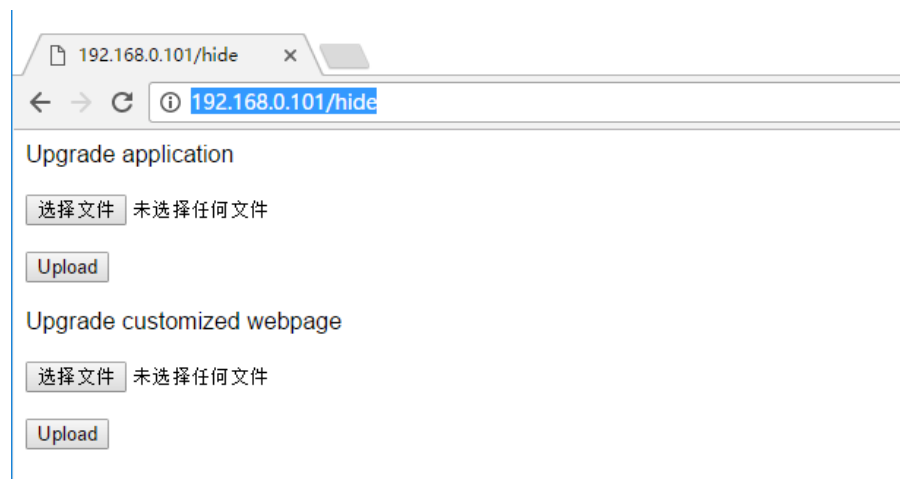

Figure 40. Internal web page

3.14. Web Page Function

Web page function can be enabled or disabled.

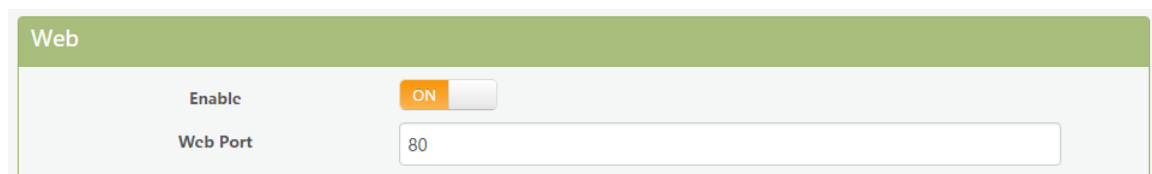

Figure 41. Web Page Function Setting

3.15. Auto-IP Function

Connect device Ethernet with PC, the device will use default auto IP. The PC may use this IP to config the device or transfer data(PC will need about 15 seconds to use default 169.254.xxx.xxx IP, then this communication can be created). As the following example, 169.254.173.207(If occur IP conflict, it will use other ip instead)



Figure 42. AUTO-IP Connection



Figure 43. AUTO-IP Config Device

```

EPORT>EPORT>Show

===System State===
Product ID:E20
Software Version:V1.10f
Config Protected:OFF
System time:NTP Disabled
Up Time: 0-Day 0:0:12
Total Free Memory: 23144
MAX Block Size:21404

===NETWORK===
MAC:F0FE6BA04AFA
Ip Address:169.254.173.207
Ip subNetMask:255.255.0.0
Gateway:0.0.0.0

```

Figure 44. Cli Command Query Device IP

3.16. Other Function

The Eport-E20 device parameters can be exported and loaded into other equipment..

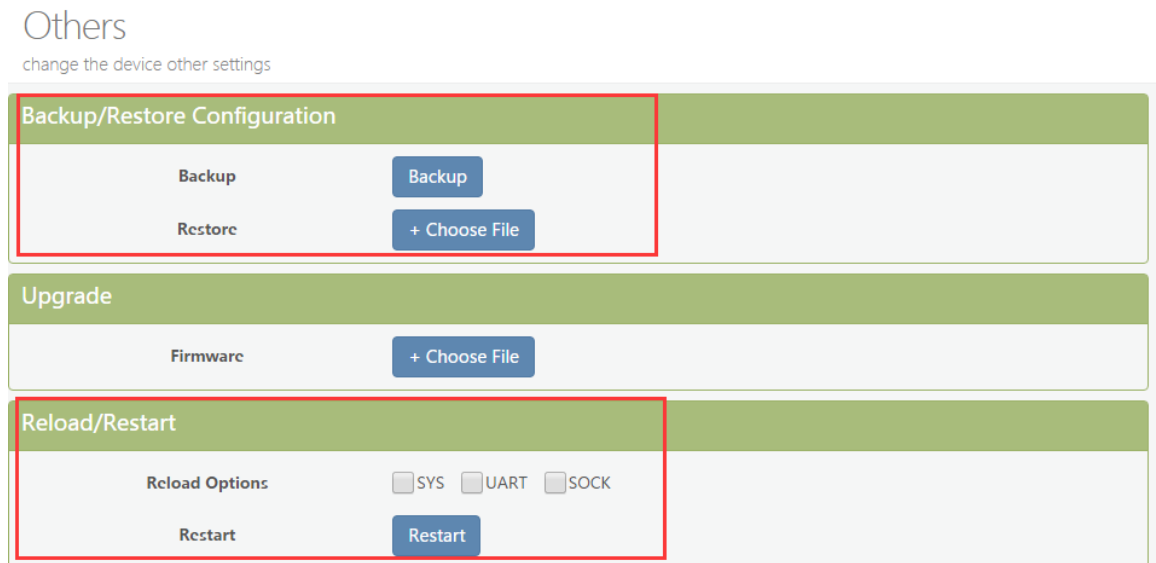

Figure 45. Other Function

3.17. NTP Function

Support NTP function(default is disabled). Support set NTP server, port, time zone information, more detailed usage see application document of "UART Fast Config".(112.124.43.15 is High-Flying test NTP server)

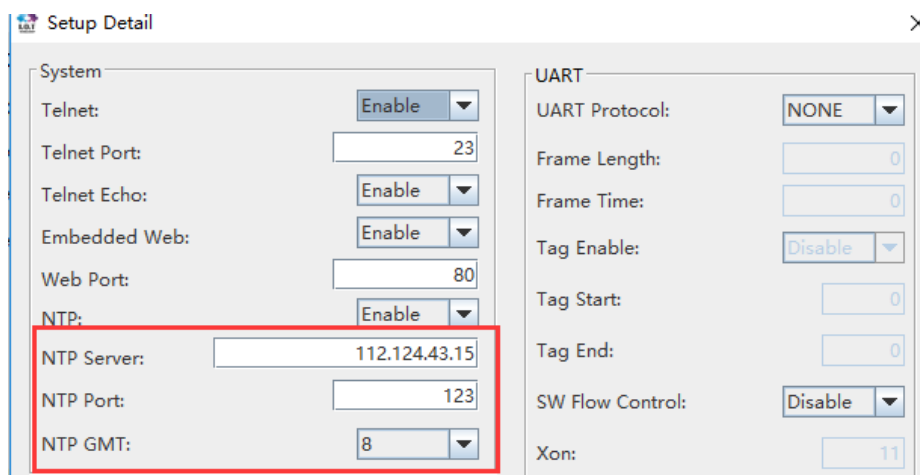

Figure 46. IOTService Tools NTP Setting

```
-----  
EPORT>SYS NTP  
Enable  
Server:112.124.43.15  
Port:123  
GMT:8  
EPORT>Show  
  
===System State===  
Product ID:HF5111B  
Software Version:V1.07c  
Config Protected:OFF  
System time:2017-1-23 13:48:38 Mon  
Up Time: 0-Day 2:44:32  
Total Free Memory: 32880  
MAX Block Size:31164
```

Figure 47. Cli Command NTP Setting and Query

3.18. Heartbeat Function

Support heartbeat function, can set the heartbeat time and content(heartbeat time is the same as keepalive setting), if the product does not receive data from TCP server within heartbeat time, it will send heartbeat to server. The heartbeat function can only be enabled when socket is set as TCP client.

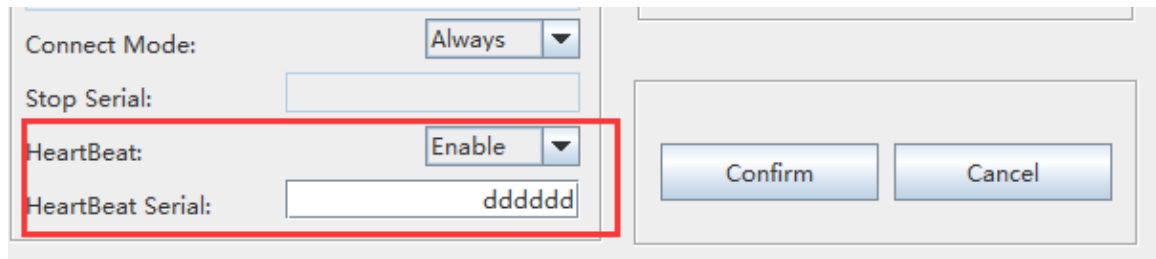

Figure 48. Heartbeat Function

3.19. UART Fast Config

Product support Cli command to config its parameters, but also support special HEX format UART data for fast config, see application manual for detailed usage.

4. CLI COMMAND NOTES

4.1. Working Mode

The device will enter into default transparent transmission mode after powered on. User can switch to Cli command mode through special UART data. Module default UART parameters are as below:

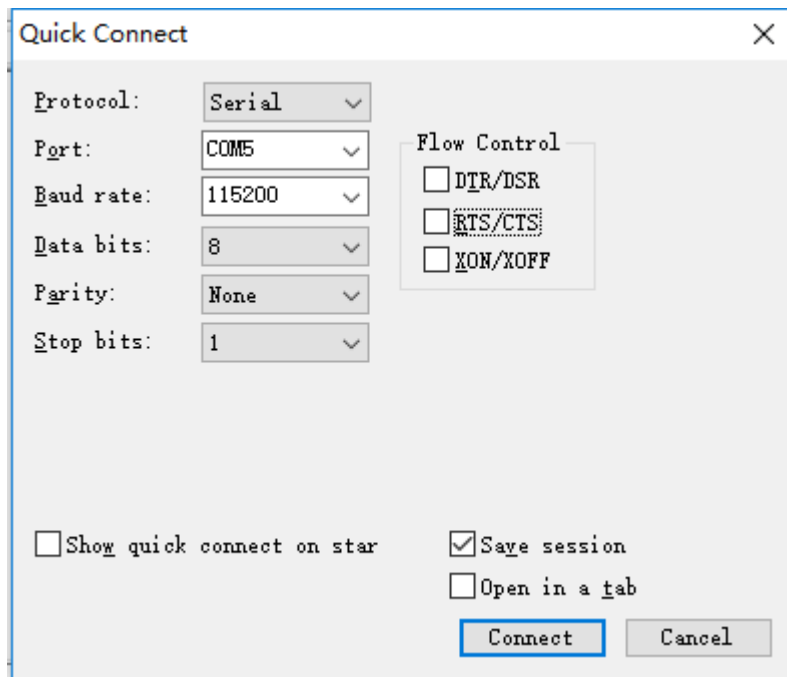

Figure 49. Eport-E20 Default: UART Parameters

In Command mode, User can use UART port to set module through Cli command.

Notes:

We recommend to use SecureCRT for UART debug tools.

4.1.1. Switch Transparent Transmission Mode to Cli Command Mode

Steps:

- Input “+++” via UART tools, the device will output “EPORT>” after received “+++”. Then the device already enters into Cli command mode.

Notes:

”+++” should be in one frame. Other data is not allowed before or after “+++”

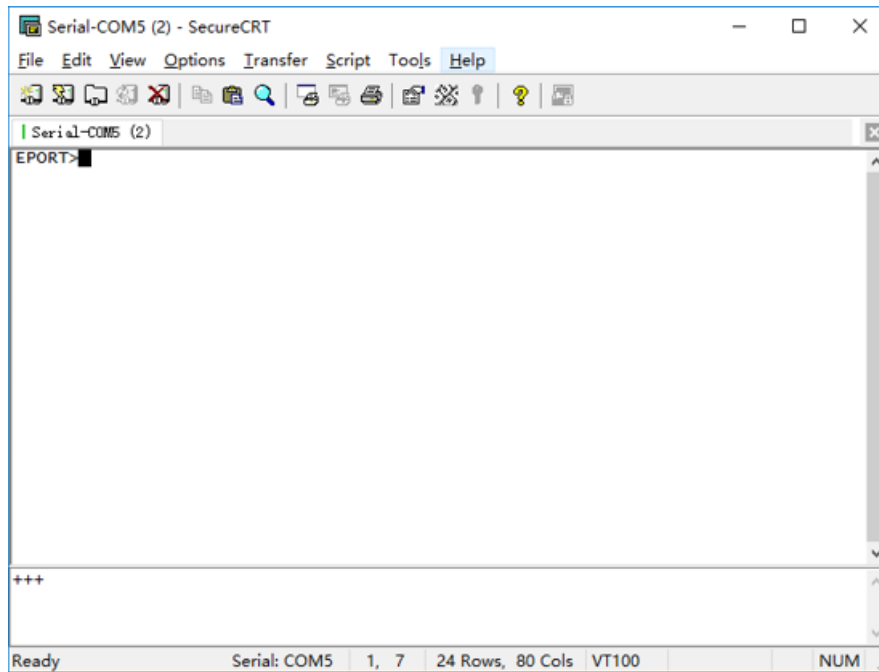

Figure 50. Switch Transparent Transmission Mode to Cli Command Mode

<Notes>:

In Cli command mode, users can set or query parameters. Cli command details see next chapter

4.2. Cli Command Overview

Cli command can be input through terminal (SecureCRT or other UART tools) or by user device MCU programming. As below picture, we use SecureCRT tool. Press “Tab” key, it will list current available Cli command or directory. If input first character and then press “Tab” key, it will show the Cli command fit with the first character.

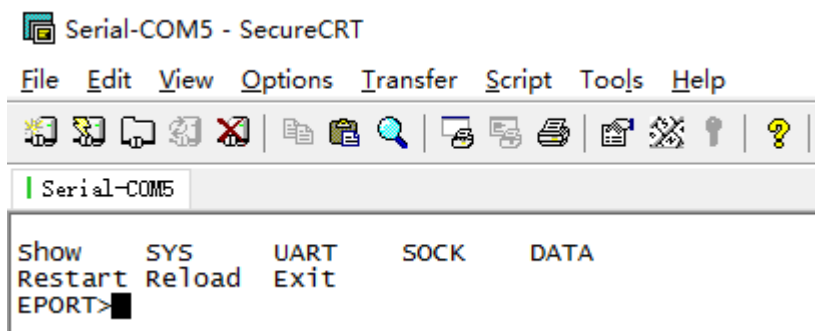

Figure 51. Cli Command Root Directory

SYS	Version		
	Auth	user	
		password	
		quit	
	Network	DHCP	Enable
			Disable
		ip address	
		gateway	
		DNS	
		HostName	
		Quit	
	Telnet	Enable	port number
		echo	
	Web	Disable	
		Enable	port number
	MAC		
	JCMD	Enable	
		Disable	
	NTP	Enable	NTP Server Address
			NTP Server port
GMT			
Disable			
Quit			

Figure 52. Cli Command SYS Tree

UART	Show		
	Baudrate		
	Databits		
	Stopbits		
	Parity		
	Buf	BufSize	
		GapTime	
		Quit	
	FlowCtrl	FlowCtrl	
		Half-Duplex	
		Disable	
	SWFlowCtrl	Enable	
		Disable	
	Cli-Getin	Disable	
		Serial-String	
		Always	
	Cli-WaitTime		
	Proto	NONE	
		Modbus	
		Frame	
Frame	FrameLen		
	FrameTime		
	Tag		
	Quit		
Edit			
Clean			
Quit			

Figure 53. Cli Command UART Tree

SOCK	New	Show	
		Proto	Name
			TCP-SERVER
			TCP-CLIENT
			UDP-SERVER
			UDP-CLIENT
			HTTP
		Telneted	
		Server	
		ServerPort	
		LocalPort	
		BufSize	
		KeepAlive	
		Timeout	
		HeartBeat	
	Security	Disable	
		TLS	
		AES	
	ConnectMode	DES	
		Always	
	Rout	Burst	
		uart	
		log	
	netp		
	netp	Show	
		Name	
		Proto	TCP-SERVER
			TCP-CLIENT
			UDP-SERVER
			UDP-CLIENT
HTTP			
Telneted			
Server			
ServerPort			
LocalPort			
BufSize			
KeepAlive			
Timeout			
HeartBeat			
Security	Disable		
	AES		
	DES		
ConnectMode	TLS		
	Always		
Rout	Burst		
	uart		
	log		
netp			
Save			
Clean			
Del			
Quit			
Quit			

Figure 54. Cli Command SOCK Tree

DATA	Str
	Hex
	Quit
FwUpgrade	
Restart	
Reload	
Exit	

Figure 55. Cli Other Command

4.2.1. Cli Command Format

Cli command is in ASCII format. The usage is similar to Linux terminal. Command format as following:

- Format Notes
 - <>: Cli command name or directory.
 - [: Cli command parameters.

- Command Message

<CMD> [para-2 para-3 para-4...]<CR>

- <CMD>: Main directory or command name;
- [para-n] : command parameters. If have multiple directory, it can also can be the son directory. As below example;

```
EPORT>SYS Auth
User          Passwrod      Quit
```

- <CR>: Command Terminator, "Enter" key, HEX data: 0x0a or 0x0d

<Notes>

If the input command not existed, UART will output again "EPORT>" to allow next command input. The Cli command is case sensitive.

```
EPORT>sys
EPORT>SYS
EPORT/SYS>
```

If need enter into son directory, press "space" key between the directories.

```
EPORT>SYS Auth
EPORT/SYS/Auth>
```

If need to display all the directory or commands in the current directory, press "Tab" key to query.

```
EPORT/SYS>
Auth   Network Telnet web   Ipv6
MAC    JCMD    Quit
```

If need to display current command parameter, press Tab key to query.

```
EPORT/SYS/Network>DHCP
Enable Disable
```

4.2.1.1. Show Command

- Function: Show all system information, including the system running status, Network status, UART status and socket status.
- Format:
 - ◆ Query

Show [SYS/UART/SOCK]

- Parameter:
 - Show all information if no parameters. Parameter can be one of the following:
 - ◆ SYS: System running status
 - ◆ UART: UART status
 - ◆ SOCK: Socket status

```

EPORT>Show
===System State===
Product ID:E-10
Software Version:V1.04
Up Time: 0-Day 0:21:39
Total Free Memory: 48400
MAX Block Size:46816

===NETWORK===
MAC:ACCF23FF4771
Ip Address:192.168.0.106
Gateway:192.168.0.1

===UART Status===
Config:115200,8,1,NONE,NONE
State:In CLI
Recv Bytes:26   Recv Frames:24
Send Bytes:0   Send Frames:0
Failed Bytes:0 Failed Frames:0

===SOCK Status===
SOCK Name:netp
State:Server Created
Client IP:
Recv Bytes:0   Recv Frames:0
Send Bytes:0   Send Frames:0
Failed Bytes:0 Failed Frames:0
  
```

4.2.1.2. SYS Directory

- Function: Display/Set all system related information
- Format:
 - ◆ Tab Query

```

EPORT/SYS>
Version Auth   Network Telnet  web
NTP          MAC          JCMD      Quit
  
```

4.2.1.3. SYS/Auth Directory

- Function: Display/Set web or Telnet Cli command login directory. (see appendix for detail)
- Format:
 - ◆ Tab Query

```

EPORT/SYS/Auth>
User          Password      Quit
  
```

4.2.1.4. SYS/Auth/User Command

- Function: Display/Set web or Telnet Cli command login user name. (function see appendix)
- Format:
 - ◆ Query
 - <User>
 - ◆ Set
 - <User> [value]
- Parameter:
 - Setting is valid immediately.
 - ◆ User: Login user name. Default: **admin**

- ◆ value: set value. Length range 1~29 characters

4.2.1.5. SYS/Auth/Password Command

- Function: Display/Set web or Telnet Cli command login password(function see appendix)
- Format:
 - ◆ Query
 - <Password>
 - ◆ Set
 - <Password> [value]
- Parameter:
 - Setting is valid immediately
 - ◆ Password: Login password. Default: **admin**
 - ◆ value: set value. Length range 1~29 characters

4.2.1.6. SYS/Network Directory

- Function: Display/Set related network information.
- Format:
 - ◆ Tab Query

EPORT/SYS/Network>				
Show	DHCP	DNS	HostName	Quit

4.2.1.7. SYS/Network/Show Command

- Function: Display network related information
- Format:
 - ◆ Query
 - <Show>

4.2.1.8. SYS/Network/DHCP Command

- Function: Display/Set DHCP Client function
- Format:
 - ◆ Query
 - <DHCP>
 - ◆ Set
 - <DHCP> [Enable/Disable]
- Parameter:
 - Setting is valid after reboot.
 - ◆ Enable: Enable DHCP function. The device will get DHCP IP from router when Ethernet port is connected to router LANN port. Default: **Enable**.
 - ◆ Disable: Disable DHCP function. Allocate device static IP address according to the hit of inputting IP and gateway address.

4.2.1.9. SYS/Network/DNS Command

- Command: Display/Set DNS IP address.
- Format:
 - ◆ Query

<DNS>

- ◆ Set

<DNS> [IP]

- Parameter:
When DHCP function is Disabled, this setting is valid. Setting is valid after reboot.
 - ◆ IP Address: DNS server address. Default: **10.10.100.254**.

4.2.1.10. SYS/Network/Hostname Instruction

- Function: Display/Set Hostname.
- Format:
 - ◆ Query

<Hostname>

- ◆ Set

<Hostname> [name]

- Parameter:
Hostname is the name which show in router DHCP client list. Setting is valid immediately.
 - ◆ Name Address: Hostname, length range: 1~30 characters. Default: **Eport-E20**.

4.2.1.11. SYS/Telnet Instruction

- Function: Display/Set Telnet function.
- Format:
 - ◆ Query

<Telnet>

- ◆ Set

<Telnet> [Enable/Disable]

- Parameter:
See appendix for detailed Telnet function usage. Telnet is used for remote send Cli command or transmit data, Setting is valid after reboot.
 - ◆ Enable: Enable Telnet function. Default: **Enable**.
 - Input Port Numbver: Telnet Port Number. Default: **23**
 - Input Echo Mode: Enable/Disable Cli command echo function. Default: **Enable**
 - ◆ Disable: Disable Telnet function.

4.2.1.12. SYS/Web Instruction

- Function: Display/Set Web config function.
- Format:
 - ◆ Query

<Web>

- ◆ Set

<Web> [Enable/Disable]

- Parameter:
Webpage is used for config module working parameters. Setting is valid after reboot.
 - ◆ Enable: Enable Web config function. Default: **Enable**.

- Input Port Number: Web Port Number. Default: **80**
- ◆ Disable: Disable Web config function

4.2.1.13. SYS/MAC Instruction

- Function: Display/Set MAC address.
- Format:
 - ◆ Query
 - <MAC>
 - ◆ Set
 - <MAC> [8888 value]
- Parameter:
 - Global unique MAC Address. It is not allowed to modify it.
 - ◆ value: MAC address value.

4.2.1.14. SYS/JCMD Instruction

- Function: Display/Set Jason command function.
- Format:
 - ◆ Query
 - <JCMD>
 - ◆ Set
 - <JCMD> [Enable/Disable]
- Parameter:
 - Jason command is used for config module. IOTManage software use this mechanism. If disable JCMD function, IOTManage is no longer valid. Setting is valid after reboot.
 - ◆ Enable: Enable JCMD function. Default: **Enable**.
 - ◆ Disable: Disable JCMD function.

4.2.1.15. SYS/NTP Instruction

- Function: Display/Set NTP function.
- Format:
 - ◆ Query
 - <NTP>
 - ◆ Set
 - <NTP> [Enable/Disable]
- Parameter:
 - NTP is used for product to get and output real time. See uart fast config application manual to fast query. Setting is valid immediately.
 - ◆ Enable: Enable NTP Function.
 - NTP Server Address: NTP Server address, domain name or IP address
 - NTP Server Port: port number, Default:123, Range;0~127
 - GMT: Time zone, default is 0, Range:-12~12.
 - ◆ Disable: Disable NTP Function, Default value.

4.2.1.16. UART Directory

- Function: Display/Set UART information directory.

- Format:
 - ◆ Tab key query

EPORT/UART>	Baudrate	Databits	Stopbits	Parity
Show	FlowCtrl	SWFlowCtrl	Cli-GetIn	Cli-waitTime
Buf	Frame	Edit	Clean	Quit
Proto				

4.2.1.17. UART/Show Instruction

- Function: Display UART information function.
- Format:
 - ◆ Query

<Show>

4.2.1.18. UART/Baudrate Instruction

- Function: Display/Set UART baud rate function.
- Format:
 - ◆ Query

<Baudrate>

- ◆ Set

<Baudrate> [value]

- Parameter:
 - Setting is valid immediately.
 - ◆ Value: Default: **115200**. Can choose 2400, 4800, 9600, 38400, 57600, 115200, 230400, 460800

4.2.1.19. UART/Databits Instruction

- Function: Display/Set UART data bits function.
- Format:
 - ◆ Query

<Databits>

- ◆ Set

<Databits> [value]

- Parameter:
 - Setting is valid immediately.
 - ◆ Value: Default: **8bits**. Can choose 8.

4.2.1.20. UART/Stopbits Instruction

- Function: Display/Set UART stop bits function.
- Format:
 - ◆ Query

<Stopbits>

- ◆ Set

<Stopbits> [value]

- Parameter:
 - Setting is valid immediately.
 - ◆ Value: Default: **1bits**. Can choose 1, 1.5, 2.

4.2.1.21. UART/Parity Instruction

- Function: Display/Set UART parity function.
- Format:
 - ◆ Query
<Parity>
 - ◆ Set
<Parity> [value]
- Parameter:
 - Setting is valid immediately.
 - ◆ Value: Default: **None**. Can choose NONE, EVEN, ODD.

4.2.1.22. UART/Buf Directory

- Function: Display/Set UART Buffer directory.
- Format:
 - ◆ Tab key query

```
EPORT/UART/Buf>
BufSize GapTime Quit
```

4.2.1.23. UART/Buf/Bufsize Instruction

- Function: Display/Set UART buffer size function.
- Format:
 - ◆ Query
<Bufsize>
 - ◆ Set
<Bufsize> [value]
- Parameter:
 - Buffer is used for cache UART received data. If the received data of one frame is larger than buffer size. The data frame will be break into two packet send to network. Setting is valid after reboot.
 - ◆ Value: Default: **512**. Length range: 32~1400 bytes.

4.2.1.24. UART/Buf/GapTime Instruction

- Function: Display/Set UART free frame gap time.
- Format:
 - ◆ Query
<GapTime>
 - ◆ Set
<GapTime> [value]
- Parameter:
 - GapTime is used for setting UART free frame time gap. If the received data gap time is more than setting value, the data packet will be broken into two frame.
 - ◆ Value: Default: **50ms**. Length Range: 10~1000ms.

4.2.1.25. UART/Buf/FlowCtrl Command

- Function: Display/Set UART flow control function.
- Format:
 - ◆ Query
<FlowCtrl>
 - ◆ Set
<FlowCtrl> [Enable/Disable]
- Parameter:

Flow control includes software flow control and hardware flow control. Software flow control priority is higher than hardware. If enable software flow control, the hardware flow control pin(CTS/RTS) will be useless. Software flow control use special UART data for control. Hardware flow control use CTS/RTS pin control. Setting is valid immediately.

 - ◆ Flow Control: Flow control function.
 - ◆ Half-Duplex: Enable RS485 half-duplex function, UART0_RTS is used for RS485 chip control function.
 - ◆ Disable: Flow control function. Default: **Disable**.

4.2.1.26. UART/Buf/SWFlowCtrl Command

- Function: Display/Set UART software flow control function.
- Format:
 - ◆ Query
<SWFlowCtrl>
 - ◆ Set
<SWFlowCtrl> [Enable/Disable]
- Parameter:

Enable software flow control function. The device UART can output data After UART received Xon single-byte enable data. When UART received Xoff single-byte disable data. It will disable the device UART output data.

 - ◆ Enable: Enable software flow control function, When in enable status, it allow UART data output when bootup by default.
 - Xon: Enable UART output data. Default: **0x11**.
 - Xoff: Disable UART output data. Default: **0x13**.
 - ◆ Disable: disable software flow control function. Default: **Disable**.

4.2.1.27. UART/Cli-Getin Command

- Function: Display/Set Cli command function
- Format:
 - ◆ Query
<Cli-Getin>
 - ◆ Set
<Cli-Getin> [Serial-String/Always/Disable]
- Parameter:

Set Cli command parameters. Setting is valid immediately.

 - ◆ Serial-String: Enable specific data to enter into Cli command mode.

- [Input Serial String]: Default: **+++**, Range 1~10 bytes. Also can input hex format data. The HEX data are separated by Spaces, Like **【30 31 32 33 34】**, When it received string data "01234", then It can enter into Cli command.
- ◆ Always: Always work in Cli command mode when device power on.
- ◆ Disable: Disable Cli command mode. UART and Telnet both can't use Cli Command.

4.2.1.28. UART/Cli-WaitTime Command

- Function: Display/Set Cli command wait time
 - ◆ Format
 - <Cli-WaitTime>**
 - ◆ Set
 - <Cli-WaitTime> [timeout]**
 - Parameter:
 - Set Cli command mode timeout exit time. If there is no Cli command sent for the waittime, It will exit Cli command mode to transparent transmission, Setting is valid immediately.
 - ◆ timeout: Default: **300s**, Range 0: Disable WaitTime function, 1~300s.

4.2.1.29. UART/Proto command

- Function: Display/Set UART protocol function
- Format:
 - ◆ Query
 - <Proto>**
 - ◆ Set
 - <Proto> [NONE/Modbus/Frame]**
 - Parameter:
 - Setting is valid immediately.
 - ◆ NONE: Default: **None**, transparent transmission, the received UART data will be directly sent to network.
 - ◆ Modbus: Modbus RTU to Modbus TCP.
 - ◆ Frame: Enable auto-frame function. Relevant parameters are set in Frame command.

4.2.1.30. UART/Frame Directory

- Function: Display/Set UART frame directory.
- Format:
 - ◆ Tab key query

```

EPORT/UART/Frame>
FrameLen      FrameTime      Tag            quit
  
```

4.2.1.31. UART/Frame/FrameLen Command

- Function: Display/Set UART auto-frame frame length
- Format:
 - ◆ Query

<FrameLen>

- ◆ Set

<FrameLen> [value]

- Parameter:
 - Set UART auto-frame length, Setting is valid immediately.
 - ◆ value: Default: **8**, Range: 8~1400.

4.2.1.32. UART/Frame/FrameTime Command

- Function: Display/Set UART auto-frame time
- Format:
 - ◆ Query

<FrameTime>

- ◆ Set

<FrameTime> [value]

- Parameter:
 - Set UART auto-frame time, Setting is valid immediately.
 - ◆ value: Default: **100ms**, Range: 100~10000.

4.2.1.33. UART/Frame/Tag Command

- Function: Display/Set UART auto-frame Tag
- Format:
 - ◆ Query

<Tag>

- ◆ Set

<Tag> [Enable/Disable]

- Parameter:
 - Set UART auto-frame tag. Only transmit data from tag head to tag tail. Filter the other datas. Setting is valid immediately.
 - ◆ Enable: Enable auto-frame tag function.
 - TagHead: LabelHead. Default: **0x55**, Single byte data.
 - TagTail: LabelTail. Default: **0xAA**, Single byte data.
 - ◆ Disable: Default: Value.

4.2.1.34. UART/Edit Command

- Function: Set UART parameter
- Format:
 - ◆ Set

<Edit> [baudrate databits stopbits parity]

- Parameter:
 - Set all UART communication parameter including baud rate, data bit, stop bit and parity.

4.2.1.35. UART/Clean Command

- Function: Clear UART transmit-receive data information
- Format:
 - ◆ Set

<Clean>

- Parameter:
Clear the UART data count(Data packet/Frame/Error packet and so on) shown in webpage.

4.2.1.36. SOCK Directory

- Function: Display/Set Socket channel directory.
- Format:
 - ◆ Tab key query

```
EPORT/SOCK>
Show      New      netp     UDP      quit
```

Netp and UDP are created socket channel. Itsupport maximum 5 Sockets.

4.2.1.37. SOCK/Show Command

- Function: Display Socket information function.
- Format:
 - ◆ Query

<Show>

4.2.1.38. SOCK/New Command

- Function: Set new Socket information
- Format:
 - ◆ Set

<New> [name]

- Parameter:
There is a default socket created(netp). It support max 5 socket channel. Every channel can be set as TCP/UDP/HTTP and so on. Setting is valid immediately.
 - ◆ Name: Socket name. Range 1~19 characters.
 - Input Sock Proto: Choose one communication method of the following.
 - TCP-SERVER: TCP Server Mode. It support max 5 TCP Client connection.
 - TCP-CLIENT: TCP Client Mode. It is used for connecting server.
 - UDP-SERVER: UDP Server Mode. Special function. Product will record the last received UDP package source IP and Port information. The received UART data will be send to this IP and port, not the setting Destination.
 - UDP-CLIENT: UDP Client Mode.
 - HTTP: HTTP Protocol transmission. The received UART data will transform to HTTP format and it will remove the HTTP header information and only output the HTTP data to UART.
 - TELNETD: Telnetd Mode. Use Telnet to config the UART Console equipment.
 - TLS: **Function is reserved. We will update it soon.**

TCP Server Mode:

- Input Local Port[0]: Set local port, Range 1~65535, 0 is random port. For TCP Server and UDP application, set it to a fixed 1~65535(TCP port 80 is used for its webpage). For TCP Client application, usually set it to 0.
- Input Buffer size[512]: Set Buffer size. Default: 512 bytes, Range:1~1400.
- Input KeepAlive[60]: Set TCP keepalive, Heartbeat time, Defalut 60s, Range: >=0.
- Input Timeout[300]: Set TCP timeout, If exceed setted time and don't received any network data package, It will break TCP connection. If working in TCP client mode, it will reconnect immediately. If it work in TCP server mode, the TCP client need to create the connction. Set this value to 0 is to close the function. The function is used for TCP to restore abnormal connection. Recommend to enable. Default: 300s, Range 0~600.
- Input Sock Security[Disable]: Security options, Used for data special encryption. Default: disable no encryption.
 - Disable: No encryption
 - TLS: TLS1.2 encryptioin, only support in TCP client mode.
 - AES: AES encryption, TCP/UDP all support this.
 - DES3: DES3 encryption, TCP/UDP all support this.
 - ◆ Input key: AES or DES3 key. For AES encryption, the key is fixed 16 bytes length, the IV value is the same as key. For DES3 encryption, the key is fixed 24 bytes length, the IV value the first 8 Bytes of key. The key can be ASCII or Hex format data. Hex format data need to use "space" character as separator, ex, "01 02 03..."
- Input Rout[uart]: Set the Socket channel output, Can choose UART and other created Socket or use as Log print using.

TCP Client Mode (Only list out difference)

- Input Server Address: Set server IPv4 address or domain name.
- Input Server Port: Set server port
- Input Local Port[0]: Same as above
- Input Buffer size[512]: Same as above
- Input KeepAlive[60]: Same as above
- Input Timeout[300]: Same as above.
- Input Sock Security[Disable]: Same as above
- Set HeartBeat[Disable]: Set Heartbeat function, default is Disable
- Input HeartBeat Serial[F0FE6B1C3D35]: Set Heartbeat content, default is MAC address
- Input Connect Mode[Always]: Set TCP Client connection mode
 - Always: TCP persistent connection. If TCP break, it will reconnect immediately.
 - Burst: It will establish connection once UART received data. If set stop function, It will disconnect after network received stop data.
 - ◆ Input Stop Serial: Set Burst Mode Stop bits. It can be ASCII or Hex format data, Hex format data need use space as separator , 1~10 bytes.

- Input Rout[uart]: Same as above

UDP Server/ UDP Client

HTTP Mode

- Input HTTP type[POST]: HTTP request type. Default: POST. Can choose POST or GET.
- Input HTTP path[/]: HTTP request path, Need start by"/". The longest byte is 63 bytes.
- Input HTTP version[1.0]: HTTP Protocol Version. Default: 1.0, Can choose 1.0 or 1.1
- Input HTTP parameters: Add HTTP head information, end by "Enter" key.If want to end the input, direct input "Enter" key. All HTTP header data length should be less than 250 bytes.

4.2.1.39. SOCK/netp directory

- Function: Display/Set Socket netp channel directory.
- Format:
 - ◆ Tab key query

EPORT/SOCK/netp>				
Show	Name	Proto	Server	ServerPort
LocalPort	BufSize	KeepAlive	Timeout	Security
HeartBeat	ConnectMode	Rout	Save	Clean
Del	Quit			

Every created Socket channel can be modified through name. The above command function is the same as New Socket command description

4.2.1.40. SOCK/netp/clean Command

- Function: Clear netp channel data packets information
- Format:
 - ◆ Set

<Clean>

- Parameter:

The network data packets information can be checked from webpage. The command will reset the data count.

4.2.1.41. DATA Directory

- Function: Display/Set Cli command mode communication
- Format:
 - ◆ Tab Query

EPORT/DATA-Str>
Hex Quit

Default: data sent in ASCII format. Also can change to send by HEX, The command is used for Cli command mode to transfer data.

4.2.1.42. Restart Command

- Function: Restart instruction.
- Format:

- ◆ Set

<Restart>

4.2.1.43. Reload Instruction

- Function: Restore Factory setting instruction.

- Format:

- ◆ Set

Reload [SYS/UART/SOCK]

- Parameter:

Reload to factory setting, if add the following parameters, it will only restore corresponding parameters. Parameter can including one of the below three:

- ◆ SYS: Restore system setting relevant paramter
- ◆ UART: Restore UART setting relevant paramter
- ◆ SOCK: Restore Socket relevant paramter

4.2.1.44. Exit Command

- Function: Exit Cli Command mode instruction

- Format:

- ◆ Set

<Exit>

4.2.1.45. Quit Command

- Function: Quit the current and go the father Cli command directory.

- Format:

- ◆ Set

<Quit>

4.2.1.46. FwUpgrade Instruction

- Function: Upgrade product firmware.

- Format:

- ◆ Set

FwUpgrade [url]

- Parameter:

Do upgrade function, if upgrade success, it will feedback "Upgrade OK", if fail, output "Upgrade FAIL", reboot to run with new firmware if success

- ◆ url: firmware url resources, Ex: http://192.168.0.101/mfw.bin

APPENDIX A: HW REFERENCE DESIGN

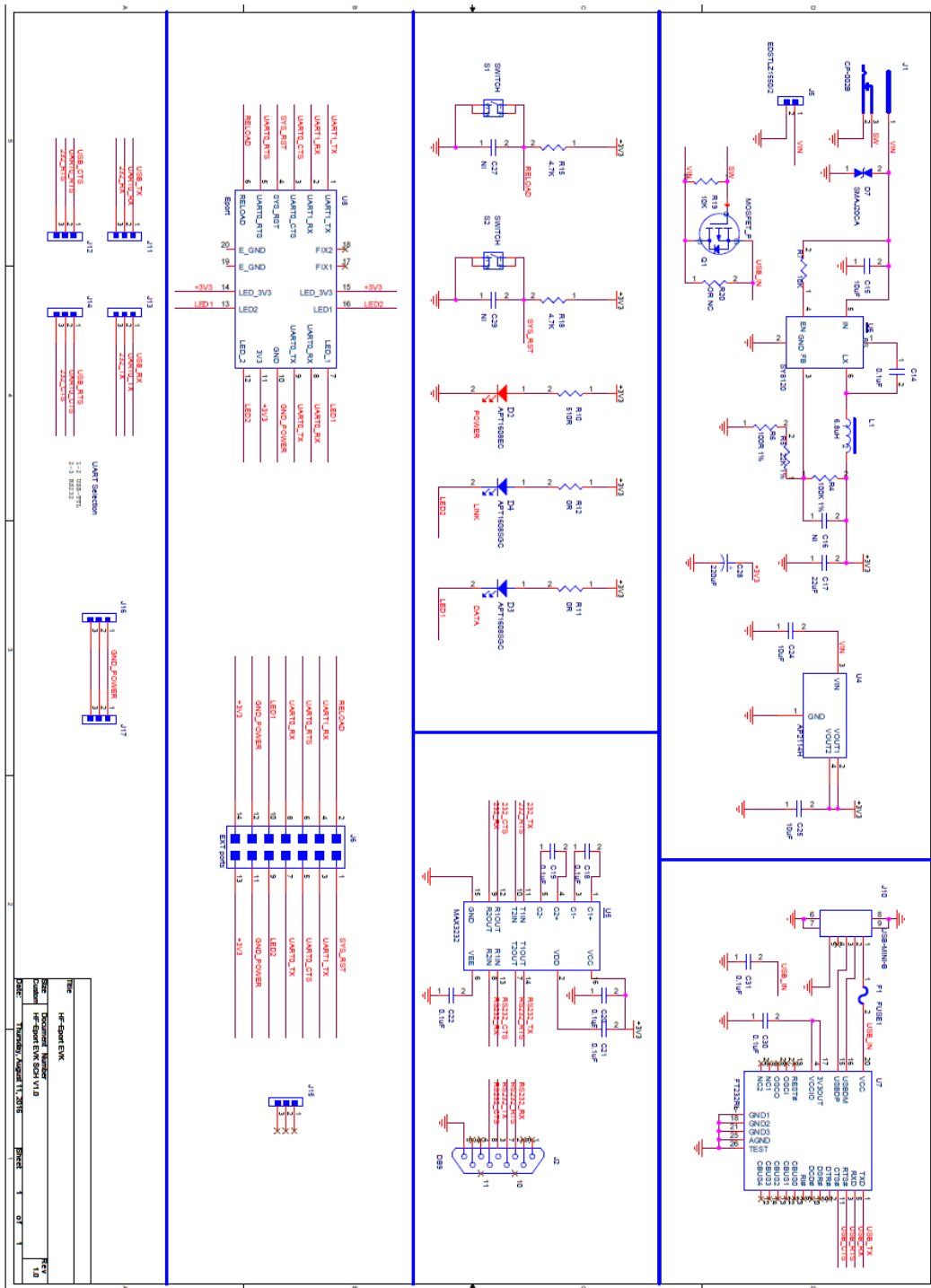

Figure 56. HW REFERENCE DESIGN

Detailed Eport-E20 Evaluation Board Design source files, pls access IOTworkshop or High-Flying web download page or contact with High-Flying technical support people to acquire.

APPENDIX B:REFERENCES

B.1. Test Tools

IOTService config and UART, Network Software can be found as following.

http://www.hi-flying.com/index.php?route=download/category&path=1_4

B.2. Application usage material

http://www.hi-flying.com/index.php?route=download/category&path=1_7

B.2. More materials

<http://www.hi-flying.com/embedded-iot-module/embedded-networking-sever/eport-e20>

APPENDIX C: TELNET COMMUNICATION FUNCTION

C.1. Telnet Use Scene:

- a) Remote management device
- b) Remote management uart equipment

C.2. Telnet Features:

- a) Telnet support echo mode,
- b) Telnet only support one Client port.
- c) Telnet port number is 23
- d) Telnet connected with TCP, If Client port don't transmit data in 300s, It will auto disconnect.

C.3. Telnet Usage:

Telnet function default as ON, If can't connect, Pls use webpage or configuration to check the function is on or off.



Telnet	
Enable	<input checked="" type="checkbox"/>
Telnet Port	<input type="text" value="23"/>
Echo	<input checked="" type="checkbox"/>

- a) Configure Secure CRT module and connect parameter, Equipment need to connect with LAN, Can use equipment LAN IP to access , If need remote to access the equipment, It need router have public IP address as port and mapped to internal website, Then can remote access equipment.

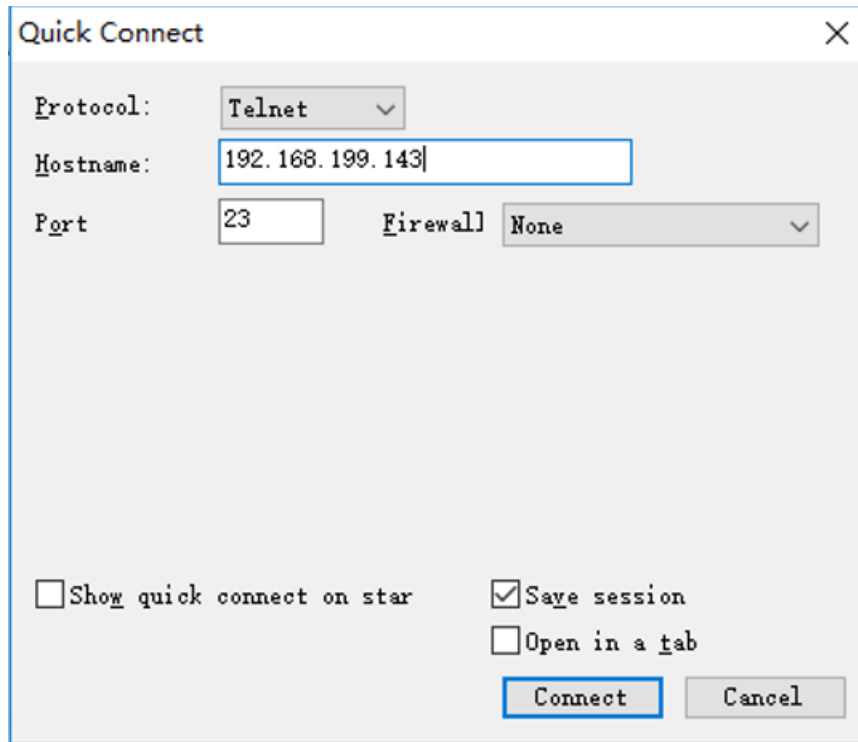

b) Use webpage account and password login in module, Then interface will show “EPORT>” .

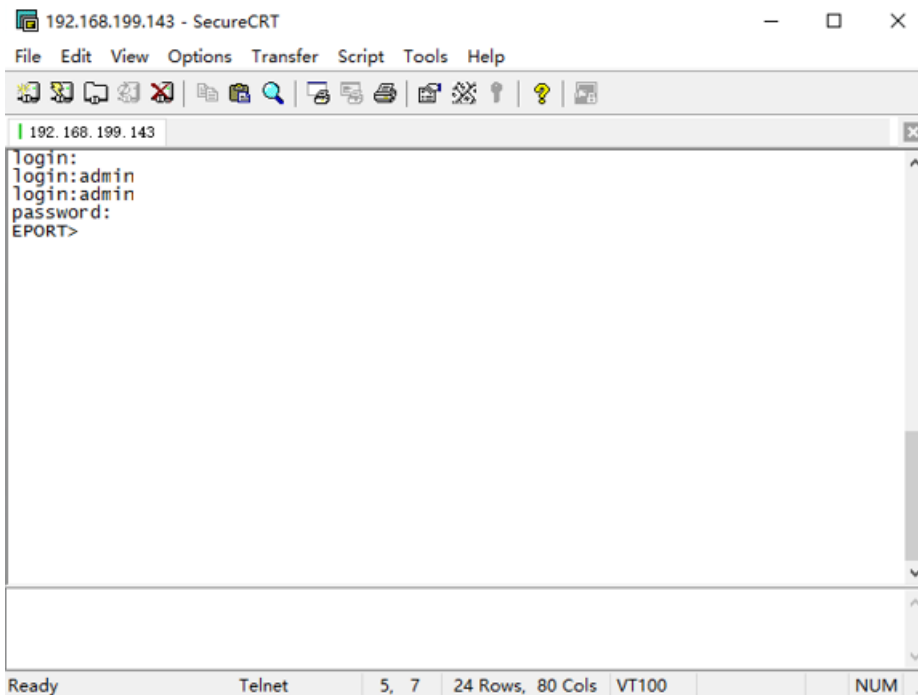

c) Later use are same as UART cli command, And can realise Telnet data with UART data transparent transmission application.,

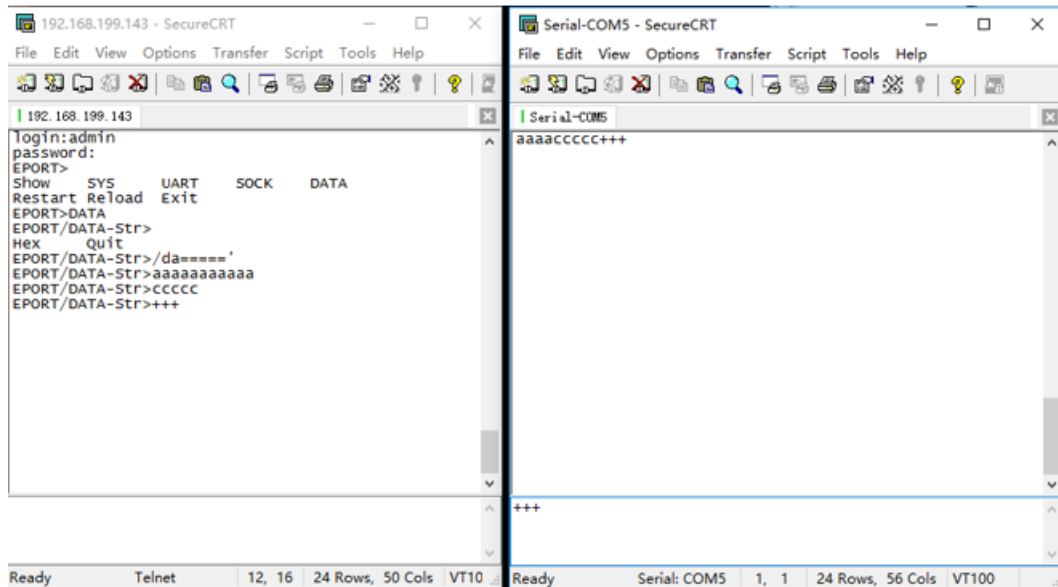

Telnet Software implementation principle:

Step 1 Establish TCP connection with module

Step 2 Module send “login”, Client port send user name(need end with Enter key,Tools can type Ctrl+Enter)

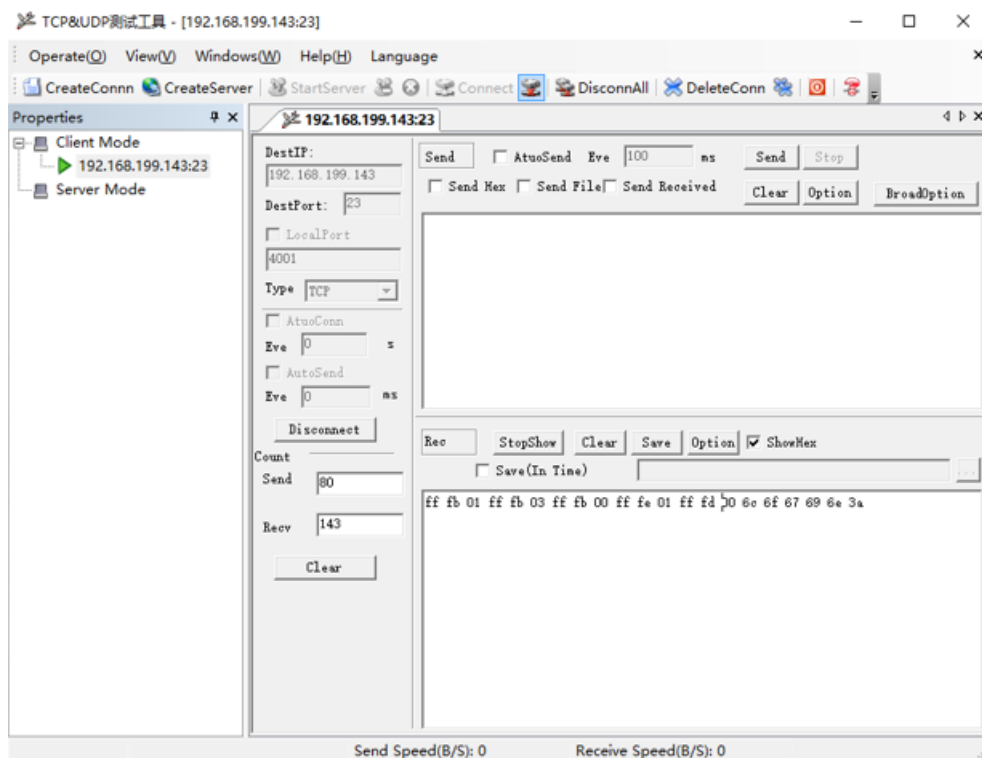

Step 3 Module send 0xFF 0xFB 0x01 Close telnet input display.

Step 4 Module send password, Client port send login password

Step 5 Module send 0xFF 0xFC 0x01 Open telnet input display

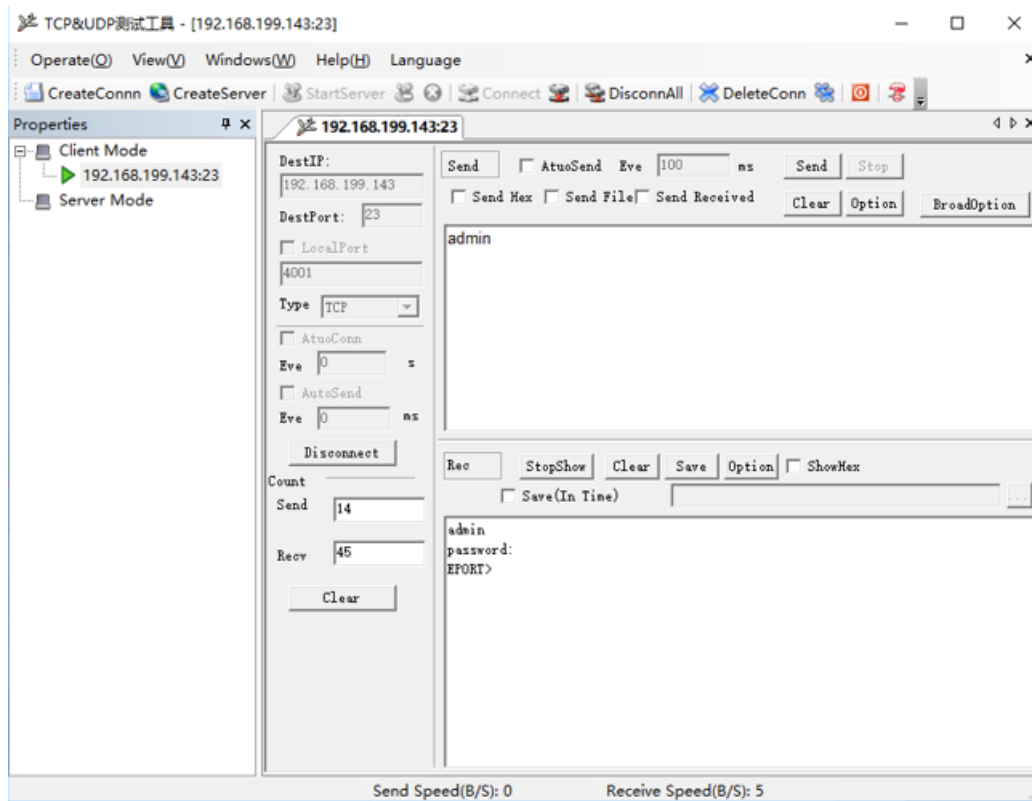

Step 6 It can send and receive Cli command After Enter into Cli command mode.

APPENDIX D: CONTACT INFORMATION

Address: Room 1002,Building 1,No.3000,Longdong Avenue,Pudong New Area,Shanghai,China,201203

Web: www.iotworkshop.com or www.hi-flying.com

Contact:

Sales: sales@iotworkshop.com

Support: support@iotworkshop.com

Service: service@iotworkshop.com

Business: business@iotworkshop.com

For more information about IOTworkshop modules, applications, and solutions, please visit our web site www.iotworkshop.com

<END OF DOCUMENT>