

25W, AC/DC converter

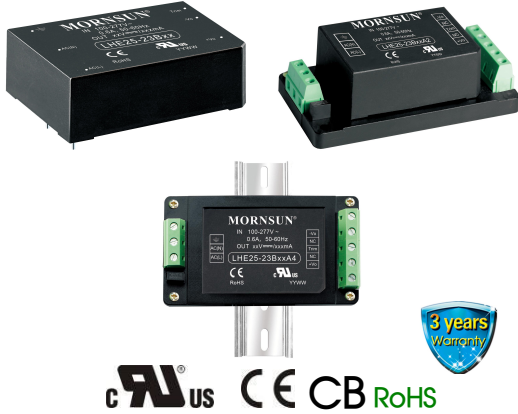

FEATURES

- Wide 85-305V Universal AC or 100-430VDC Input voltage
- Accepts AC or DC input (dual-use of same terminal)
- Operating ambient temperature range: -40°C to +85°C
- High I/O Isolation test voltage up to 4000VAC
- Regulated output, low ripple & noise
- Output short circuit, over-current, over-voltage protection
- High efficiency, high reliability
- Plastic case meets UL94V-0 flammability
- Meet EMI CISPR32/EN55032 CLASS B
- IEC/EN/UL62368 safety approval

LHE25-23Bxx AC-DC converters are highly efficient, environmental-friendly 25W power modules. It features universal AC input and at the same time accepts DC input voltage, low power consumption, high efficiency, high reliability and double or reinforced insulation with an input to output isolation test voltage of 4000VAC. The converters meet IEC/EN61000-4, CISPR32/EN55032, UL/IEC62368 and EN62368 standards, and are widely used in industrial, electricity and civil applications. For extremely harsh EMC environment, we recommend using the application circuit show in Design Reference of this datasheet.

Selection Guide

Certification	Part No.	Output Power	Nominal Output Voltage and Current (Vo/Io)	Efficiency at 230VAC (%) Typ.	Capacitive Load (μF) Max.
CE/UL/CB	LHE25-23B03	13.53W	3.3VDC/4100mA	75	48000
	LHE25-23B05	20.5W	5VDC/4100mA	78	12240
	LHE25-23B09	22.5W	9VDC/2500mA	80	5600
	LHE25-23B12	25W	12VDC/2100mA	82	5400
	LHE25-23B15	24W	15VDC/1600mA	83	2400
	LHE25-23B24	26.4W	24VDC/1100mA	85	1440
	LHE25-23B48	24W	48VDC/500mA	87	600

Note: * Use suffix "A2" for chassis mounting and suffix "A4" for Din-Rail mounting.

Input Specifications

Item	Operating Conditions	Min.	Typ.	Max.	Unit
Input Voltage Range	AC input	85	--	305	VAC
	DC input	100	--	430	VDC
Input Frequency		47	--	63	Hz
Input Current	115VAC	--	--	0.6	A
	230VAC	--	--	0.34	
Inrush Current	115VAC	--	20	--	A
	230VAC	--	40	--	
Recommended External Input Fuse		3.15A/300V, slow-blow, required			
Hot Plug		Unavailable			

Output Specifications

Item	Operating Conditions	Min.	Typ.	Max.	Unit	
Output Voltage Accuracy	All load range	3.3V Output	--	±3	--	%
		others	--	±2	--	
Line Regulation	Rated load	--	±0.5	--	%	
Load Regulation	0% - 100% load	--	±1	--		
Ripple & Noise*	20MHz bandwidth (peak-to-peak value)	--	50	100	mV	
Temperature Coefficient		--	±0.02	--	%/°C	
Stand-by Power Consumption	230VAC	--	--	0.5	W	
Short Circuit Protection		Hiccup, continuous, self-recovery				

Over-current Protection		120%-300%Io, self-recovery			
Over-voltage Protection	3.3V/5V Output	--	--	7.5	V
	9V Output	--	--	15	
	12V/15V Output	--	--	20	
	24V Output	--	--	30	
	48V Output	--	--	60	
Minimum Load		0	--	--	%
Hold-up Time	115VAC Input	--	10	--	ms
	230VAC Input	--	60	--	

Note: * The "parallel cable" method is used for ripple and noise test, please refer to AC-DC Converter Application Notes for specific information.

General Specifications

Item	Operating Conditions	Min.	Typ.	Max.	Unit
Isolation Test	Input - Output	4000	--	--	VAC
	Input - PE	2500	--	--	
Operating Temperature		-40	--	+85	°C
Storage Temperature		-40	--	+85	
Storage Humidity		--	--	95	%RH
Soldering Temperature	Wave-soldering	260 ± 5°C; time: 5 - 10s			
	Manual-welding	360 ± 10°C; time: 3 - 5s			
Power Derating	-40°C to -10°C	1.67	--	--	% / °C
	+50°C to +70°C	3.00	--	--	
	+70°C to +85°C	2.00	--	--	
	85VAC - 100VAC	1.00	--	--	% / VAC
	277VAC - 305VAC	1.00	--	--	
Safety Standard		IEC62368/EN62368/UL62368			
Safety Certification		IEC62368/EN62368/UL62368			
Safety Class		CLASS II			
MTBF		MIL-HDBK-217F@25°C > 300,000 h			

Mechanical Specifications

Case Material		Black flame-retardant and heat-resistant plastic (UL94V-0)
Dimensions	Horizontal package	70.00 x 48.00 x 23.50 mm
	A2 chassis package	96.10 x 54.00 x 32.00mm
	A4 DIN-rail package	96.10 x 54.00 x 36.60mm
Weight	Horizontal package/A2 chassis package/A4 DIN-rail package	120g (Typ.)/170g (Typ.)/210g (Typ.)
Cooling Method		Free air convection

Electromagnetic Compatibility (EMC)

Emissions	CE	CISPR32/EN55032	CLASS B	
	RE	CISPR32/EN55032	CLASS B	
Immunity	ESD	IEC/EN61000-4-2	Contact ±6KV/Air ±8KV	Perf. Criteria B
	RS	IEC/EN61000-4-3	10V/m	perf. Criteria A
	EFT	IEC/EN61000-4-4	±2KV	perf. Criteria B
		IEC/EN61000-4-4	±4KV (See Fig. 2 for recommended circuit)	perf. Criteria B
	Surge	IEC/EN61000-4-5	line to line ±1KV/ line to ground ±2KV	perf. Criteria B
		IEC/EN61000-4-5	line to line ±2KV/ line to ground ±4KV (See Fig. 2 for recommended circuit)	perf. Criteria B
	CS	IEC/EN61000-4-6	10Vr.m.s	perf. Criteria A
Voltage dips, short interruptions and voltage variations immunity	IEC/EN61000-4-11	0%, 70%	perf. Criteria B	

Product Characteristic Curve

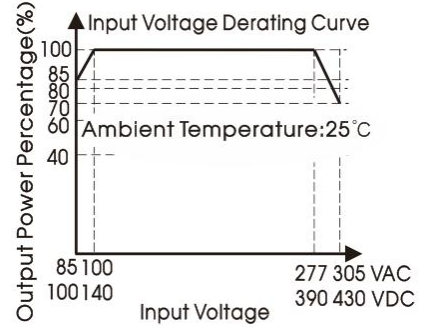
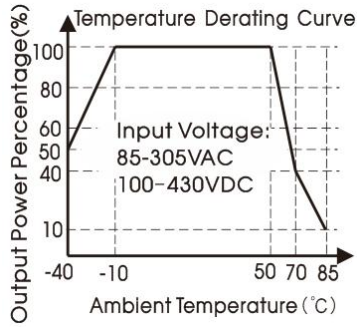

Note: ① With an AC input between 85 - 100VAC/277 - 305VAC and a DC input between 100 - 140VDC/390 - 430VDC, the output power must be derated as per temperature derating curves;

② This product is suitable for applications using natural air cooling; for applications in closed environment please consult factory or one of our FAE.

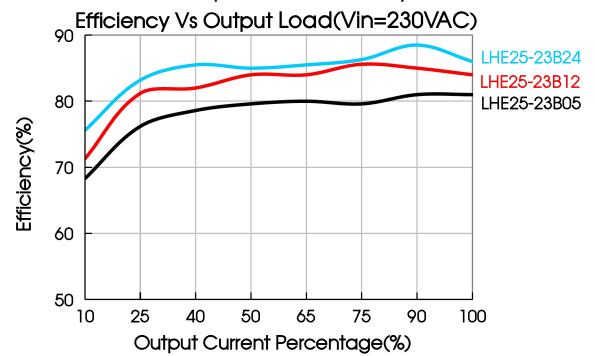
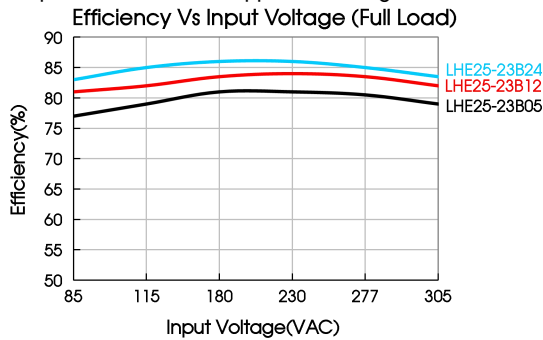

Design Reference

1. Typical application circuit

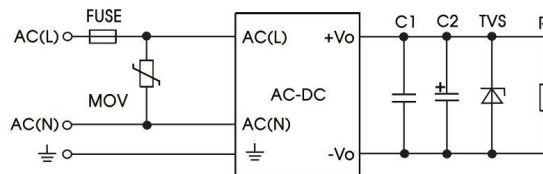

Fig. 1

Part No.	C1(μF)	C2(μF)	FUSE	MOV	TVS
LHE25-23B03	1	330	3.15A/300V slow-blow, required	S14K350	SMBJ7.0A
LHE25-23B05		330			SMBJ7.0A
LHE25-23B09		330			SMBJ12A
LHE25-23B12		330			SMBJ20A
LHE25-23B15		330			SMBJ20A
LHE25-23B24		120			SMBJ30A
LHE25-23B48		68			SMBJ64A

Note:
We recommend using an electrolytic capacitor with high frequency, and low ESR rating for C2 (refer to manufacture's datasheet). Choose a capacitor voltage rating with at least 20% margin, in other words not exceeding 80%. C1 is a ceramic capacitor used for filtering high-frequency noise and TVS is a recommended suppressor diode to protect the application in case of a converter failure.

2. EMC compliance recommended circuit

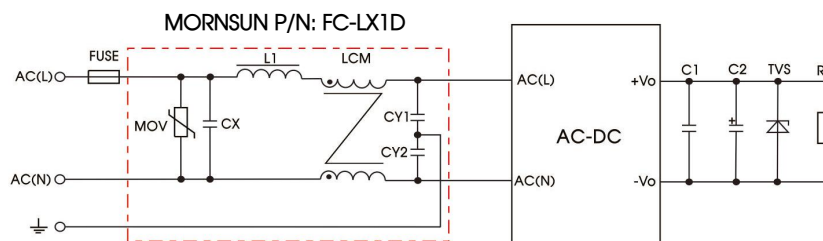
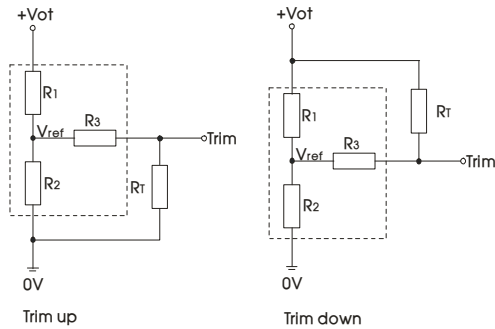

Fig.2

Component	Recommended value
MOV	S14K350
CY1 , CY2	1000pF/400VAC
CX	0.1μF/310VAC
LCM	10mH, we recommend using part no. FL2D-Z5-103 (MORNSUN)
L1	4.7μH/2A
FC-LX1D	2KV/4KV EMC filter
FUSE	3.15A/300V, slow-blow, required

3. Trim Function for Output Voltage Adjustment (open if unused)



Calculation formula of Trim resistance:

$$\text{up: } R_T = \frac{\alpha R_2}{R_2 - \alpha} - R_3 \quad \alpha = \frac{V_{ref}}{V_{ot} - V_{ref}} \cdot R_1$$

$$\text{down: } R_T = \frac{\alpha R_1}{R_1 - \alpha} - R_3 \quad \alpha = \frac{V_{ot} - V_{ref}}{V_{ref}} \cdot R_2$$

R_T = Trim Resistor value;
 α = Self-defined parameter;

Trim resistor connection (dashed line shows internal resistor network)

V _{out}	R1(KΩ)	R2(KΩ)	R3(KΩ)	V _{ref} (V)	V _{ot} (V)
3.3V	2	1.19	1	1.24	Output voltage after regulation, variation ≤ ±10%
5V	3.3	3.3	1	2.5	
9V	7.5	2.87	1	2.5	
12V	3.83	1	1	2.5	
15V	7.5	1.5	1	2.5	
24V	8.66	1	1	2.5	
48V	27	1.49	1	2.5	

4. For additional information please refer to application notes on www.mornsun-power.com

Dimensions and Recommended Layout

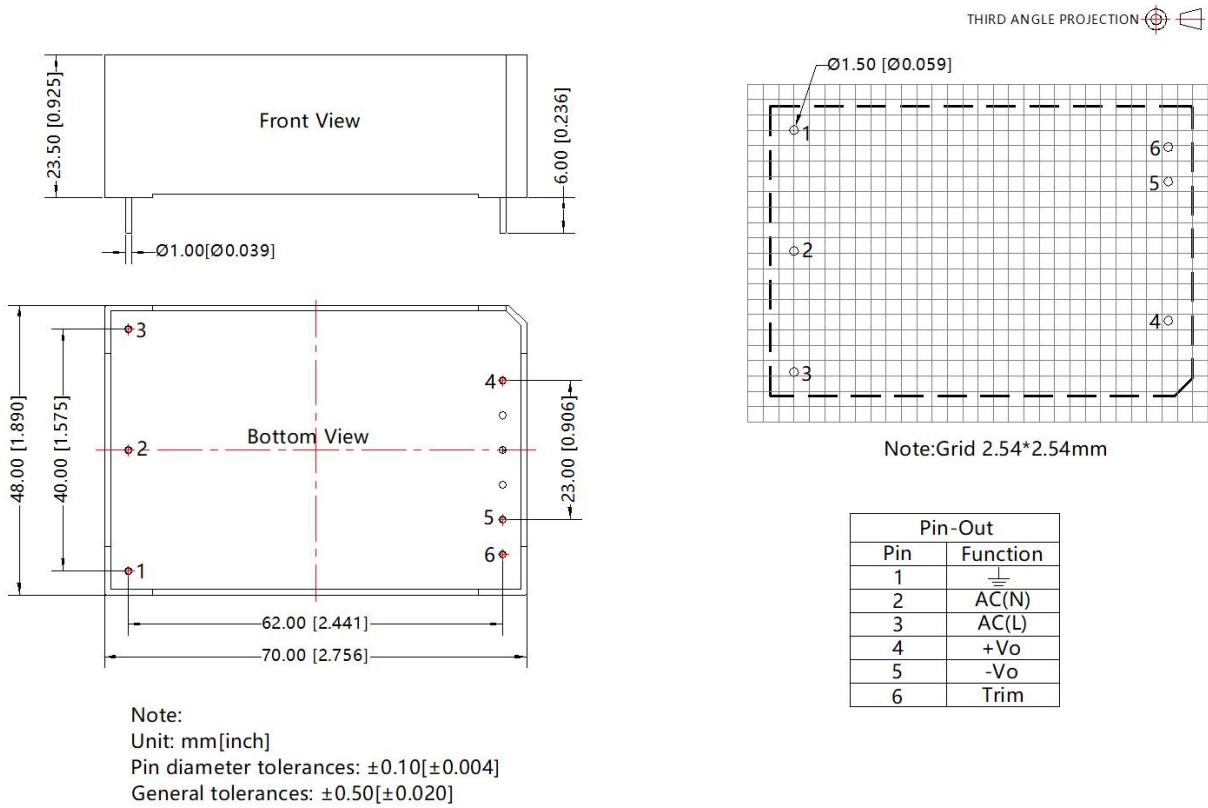

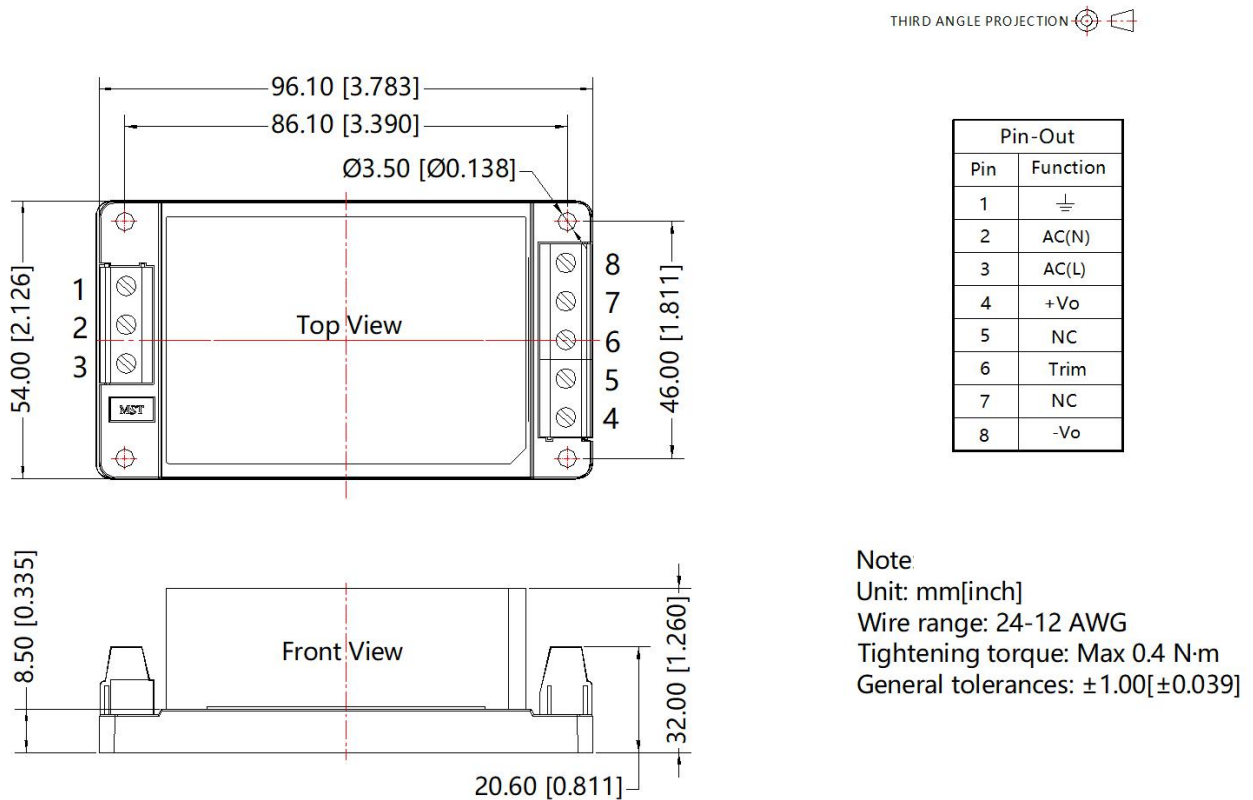

A2 Dimensions

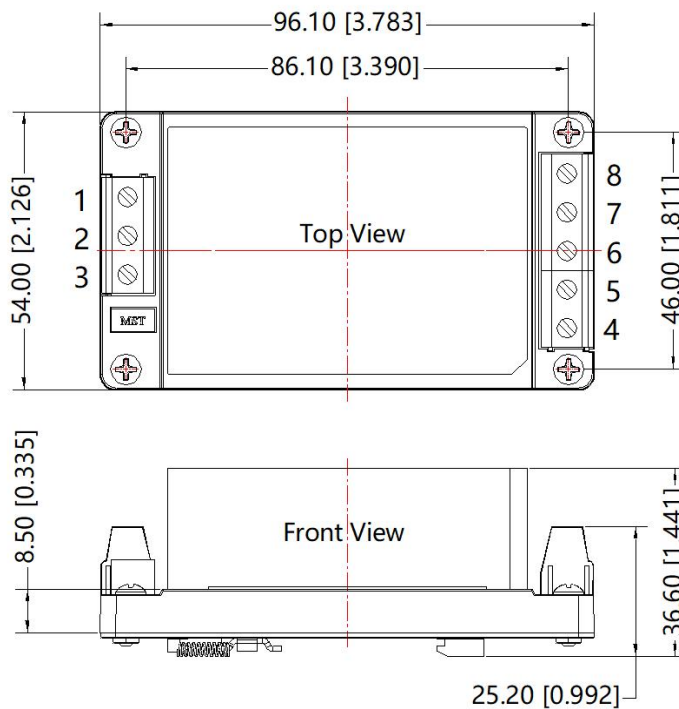

A4 Dimensions

THIRD ANGLE PROJECTION 



Pin-Out	
Pin	Function
1	
2	AC(N)
3	AC(L)
4	+Vo
5	NC
6	Trim
7	NC
8	-Vo

Note:
Unit: mm[inch]
Mounting rail: TS35, rail needs to connect safety ground
Wire range: 24-12 AWG
Tightening torque: Max 0.4 N·m
General tolerances: $\pm 1.00[\pm 0.039]$

Notes:

1. For additional information on Product Packaging please refer to www.mornsun-power.com. Packaging bag number of Horizontal package: 58220006 (Horizontal package); 58220010 (A2/A4 package);
2. Unless otherwise specified, parameters in this datasheet were measured under the conditions of $T_a=25^\circ\text{C}$, humidity<75% with nominal input voltage and rated output load;
3. All index testing methods in this datasheet are based on our company corporate standards;
4. We can provide product customization service, please contact our technicians directly for specific information;
5. Products are related to laws and regulations: see "Features" and "EMC";
6. Our products shall be classified according to ISO14001 and related environmental laws and regulations, and shall be handled by qualified units.

Mornsun Guangzhou Science & Technology Co., Ltd.

Address: No. 5, Kehui St. 1, Kehui Development Center, Science Ave., Guangzhou Science City, Huangpu District, Guangzhou, P. R. China
Tel: 86-20-38601850 Fax: 86-20-38601272 E-mail: info@mornsun.cn www.mornsun-power.com