

10-25W, AC/DC converter



FEATURES

- 85 - 264V Universal AC or wide 100 - 370VDC Input
- Regulated output, low output ripple & noise
- High efficiency up to 85%
- Output short circuit, over-current, over-voltage protection
- Plastic case meets flammability per UL94V-0
- Meets IEC/EN61000-4, CISPR32/EN55032 standard
- Special designed for power systems
- Mounting: PCB mounting, Chassis mounting, DIN-Rail mounting available

LH(ER2) series — is the improved version of Mornsun's dedicated power converter for electricity systems. It features universal AC input and at the same time accepts DC input voltage, high efficiency, high reliability, reinforced isolation. It offers good EMC performance, meets IEC61000 standards, widely used in power systems applications. For extremely harsh EMC environment, we recommend using the application circuit show in Design Reference of this datasheet.

Selection Guide

Certification	Part No.	Output Power	Nominal Output Voltage and Current		Efficiency at 230VAC (%) Typ.	Capacitive Load (μF) Max.		
			(Vo1/Io1)	(Vo2/Io2)		Vo1	Vo2	
--	LH10-10B05ER2	10W	5V/2000mA	--	74	9440	--	
	LH10-10B12ER2		12V/900mA	--	79	2400	--	
	LH10-10B24ER2		24V/450mA	--	81	370	--	
	LH10-10D0505-02ER2		5V/1800mA	5V/200mA	75	8000	540	
	LH10-10D0512-02ER2		5V/1500mA	12V/200mA	77	4000	260	
	LH10-10D0524-02ER2		5V/1000mA	24V/200mA	77	4000	170	
	--	LH15-10B05ER2	15W	5V/2800mA	--	76	20000	--
		LH15-10B12ER2		12V/1250mA	--	80	5200	--
		LH15-10B24ER2		24V/650mA	--	83	900	--
		LH15-10D0512-04ER2		5V/2000mA	12V/400mA	80	12000	1800
		LH15-10D0524-02ER2		5V/2000mA	24V/200mA	80	13000	800
	UL/CE/CB	LH25-10B05ER2	25W	5V/4100mA	--	79	12000	--
		LH25-10B12ER2		12V/2100mA	--	83	4700	--
		--		LH25-10B15ER2	15V/1600mA	--	84	2400
	LH25-10B24ER2		24V/1100mA	--	85	1000	--	

Note: *Part No. with suffix of "A2" means chassis mounting and suffix of "A4" means DIN-Rail mounting.

Input Specifications

Item	Operating Conditions		Min.	Typ.	Max.	Unit
Input Voltage Range	AC input		85	--	264	VAC
	DC input		100	--	370	VDC
Input Frequency			47	--	63	Hz
Input Current	115VAC	LH10 models	--	--	0.26	A
		LH15 models	--	--	0.37	
		LH25 models	--	--	0.6	
	230VAC	LH10 models	--	--	0.16	
		LH15 models	--	--	0.22	
		LH25 models	--	--	0.34	
Inrush Current	115VAC	LH10/LH15 models	--	10	--	
		LH25 models	--	16	--	
	230VAC	LH10/LH15 models	--	20	--	
		LH25 models	--	30	--	

Leakage Current	230VAC/50Hz	0.3mA RMS typ.
Recommended External Input Fuse(Chassis mounting, DIN-Rail mounting package series include fuse)	LH10/LH15 models	2A/250V, slow-blow
	LH25 models	3.15A/250V, slow-blow
Hot Plug		Unavailable

Output Specifications

Item	Operating Conditions		Min.	Typ.	Max.	Unit
Output Voltage Accuracy	Primary output		--	±2	--	
	Secondary output		--	±10	--	
Line Regulation	Full load	Primary output	--	±0.5	--	%
		Secondary output	--	±1.5	--	
Load Regulation	10%-100% load	Single output	--	±1	--	
		Isolated and separated dual output (balanced load)	Primary output	--	±3	
			Secondary output	--	±5	--
Ripple & Noise*	20MHz bandwidth (peak-peak value)		--	100	200	mV
Temperature Coefficient	Primary output		--	±0.02	--	%/°C
	Secondary output		--	±0.15	--	
Short Circuit Protection	Continuous, auto resume					
Over-current Protection	≥110%Io, self-recovery					
Over-voltage Protection	5VDC Output		≤7.5VDC			
	12VDC Output		≤20VDC			
	15VDC Output		≤25VDC			
	24VDC Output		≤30VDC			
Min. Load	Single output		0	--	--	%
	Isolated and separated dual output (balanced load)		10	--	--	
Hold-up Time	115VAC input		--	15	--	ms
	230VAC input		--	80	--	

Note: * The "parallel cable" method is used for ripple and noise test, please refer to AC-DC Converter Application Notes for specific information.

General Specifications

Item	Operating Conditions		Min.	Typ.	Max.	Unit
Isolation Voltage	Input-output	Electric Strength Test for 1min., leakage current <5mA	3000	--	--	VAC
	Input- 		3000	--	--	
Operating Temperature			-40	--	+70	°C
Storage Temperature			-40	--	+85	
Storage Humidity			--	--	95	%RH
Soldering Temperature	Wave-soldering		260 ± 5°C; time: 5 - 10s			
	Manual-welding		360 ± 10°C; time: 3 - 5s			
Switching Frequency			--	65	--	kHz
Power Derating	+55°C to +70°C		3.75	--	--	%/°C
	85 - 100 VAC		1.67	--	--	
	240 - 264 VAC		0.83	--	--	
Safety Standard	IEC60950/ UL60950 / EN60950					
Safety Certification	IEC60950/ UL60950 / EN60950					
Safety Class	CLASS I					
MTBF	MIL-HDBK-217F@25°C > 300,000 h					

Mechanical Specifications

Case Material	Black plastic, flame-retardant and heat-resistant (UL94V-0)
Package Dimensions	Refer to the Dimensions
Weight	Refer to the Dimensions
Cooling method	Free air convection

Electromagnetic Compatibility (EMC)

Emissions	CE	CISPR32/EN55032	CLASS A	
		CISPR32/EN55032	CLASS B (See Fig. 3 for recommended circuit)	
	RE	CISPR32/EN55032	CLASS A	
		CISPR32/EN55032	CLASS B (See Fig. 3 for recommended circuit)	
Immunity	ESD	IEC/EN61000-4-2	Contact $\pm 6KV$ /Air $\pm 8KV$	Perf. Criteria B
	RS	IEC/EN61000-4-3	10V/m	perf. Criteria A
	EFT	IEC/EN61000-4-4	$\pm 4KV$	perf. Criteria B
	Surge	IEC/EN61000-4-5	line to line $\pm 2KV$ / line to ground $\pm 4KV$	perf. Criteria B
		IEC/EN61000-4-5	line to line $\pm 4KV$ / line to ground $\pm 6KV$ (See Fig. 3 for recommended circuit)	perf. Criteria B
	CS	IEC/EN61000-4-6	10Vr.m.s	perf. Criteria A
Voltage dips, short interruptions and voltage variations immunity	IEC/EN61000-4-11	0%, 70%	perf. Criteria B	

Product Characteristic Curve

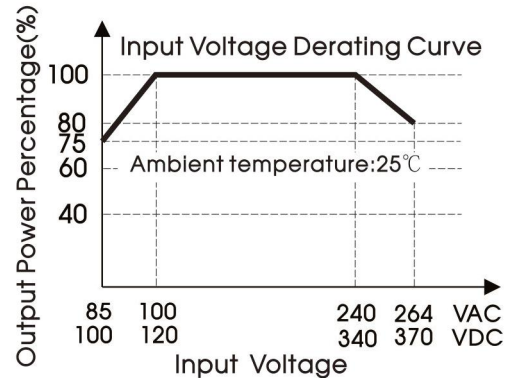
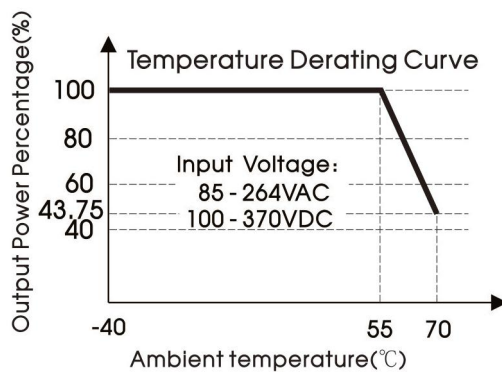

Note: ① With an AC input between 85-100VAC/240-264VAC and a DC input between 100-120VDC/340-370VDC, the output power must be derated as per temperature derating curves;

② This product is suitable for applications using natural air cooling; for applications in closed environment please consult factory or one of our FAE.

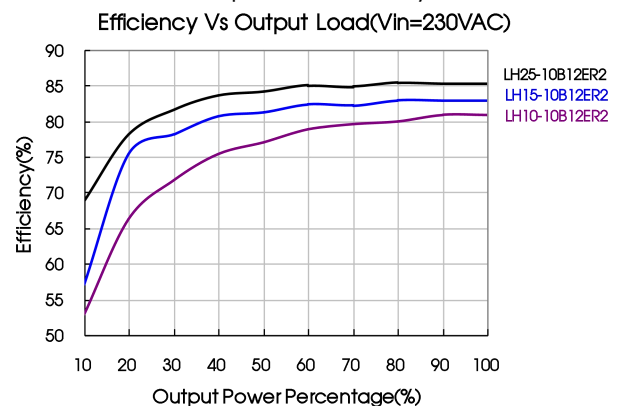
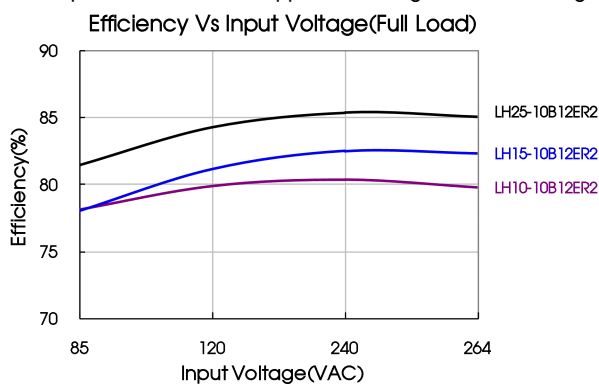

Design Reference

1. Typical application

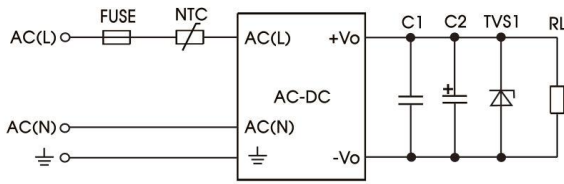

Fig. 1 LH**-10B**ER2(Single output)

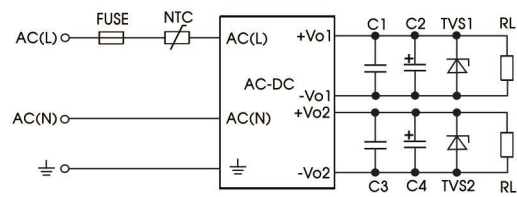

Fig. 2 LH**-10D**ER2(Dual double isolation)

Part No.	FUSE	NTC	C1/C3(uF)	C2(uF)	C4(uF)	TVS1	TVS2
LH10-10B05ER2	2A/250V, slow-blow, required	5D-9	1	330	--	SMBJ7.0A	--
LH10-10B12ER2				120	--	SMBJ20A	--
LH10-10B24ER2				68	--	SMBJ30A	--
LH15-10B05ER2				680	--	SMBJ7.0A	--
LH15-10B12ER2				220	--	SMBJ20A	--
LH15-10B24ER2				68	--	SMBJ30A	--
LH25-10B05ER2	3.15A/250V, slow-blow, required	5D-9	1	330	--	SMBJ7.0A	--
LH25-10B12ER2				330	--	SMBJ20A	--
LH25-10B15ER2				330	--	SMBJ20A	--
LH25-10B24ER2				120	--	SMBJ30A	--
LH10-10D0505-02ER2	2A/250V, slow-blow, required	5D-9	1	220	68	SMBJ7.0A	SMBJ7.0A
LH10-10D0512-02ER2				220	68	SMBJ7.0A	SMBJ20A
LH10-10D0524-02ER2				220	47	SMBJ7.0A	SMBJ30A
LH15-10D0524-02ER2				470	47	SMBJ7.0A	SMBJ30A
LH15-10D0512-04ER2				470	220	SMBJ7.0A	SMBJ20A

Output Filter Components:

We recommend using an electrolytic capacitor with high frequency, and low ESR rating for C2, C4 (refer to manufacture's datasheet). Choose a capacitor voltage rating with at least 20% margin, in other words not exceeding 80%. C1, C3 is a ceramic capacitor used for filtering high-frequency noise and TVS is a recommended suppressor diode to protect the application in case of a converter failure.

2. EMC compliance recommended circuit

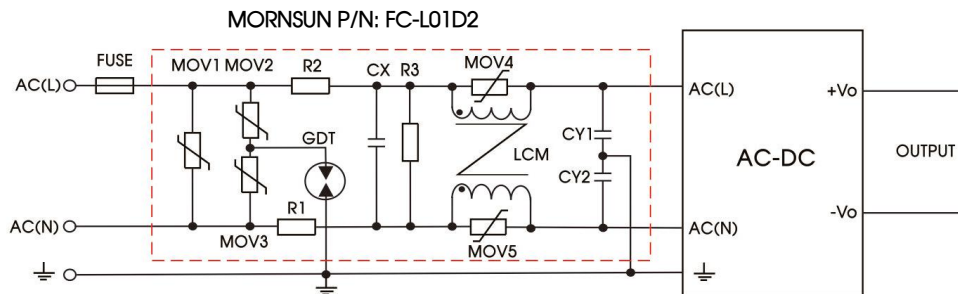
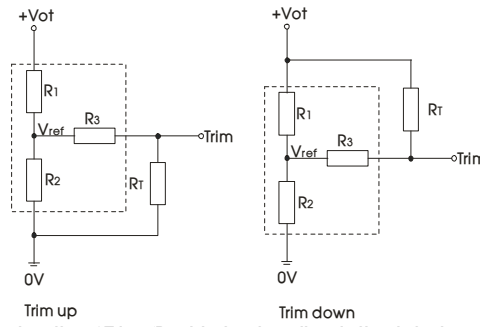

Fig 3 LH**-10***ER2 series EMC Recommended circuit with higher requirements (Output external circuit is the same as the Typical application circuit)

Component	Recommended value	Component	Recommended value	
MOV1	S20K350	FC-L01D2	EMC filter	
MOV2/MOV3	S14K350	CY1, CY2	2200pF/400VAC	
MOV4/MOV5	S07K350	GDT	B 5G3600	
CX	0.15μF/300VAC	R3	1MΩ/2W	
R1, R2	2 Ω /3W Winding resistance	FUSE	LH10/LH15 models	2A/250V, slow-blow, required
LCM	10mH, recommended to use MORNSUN's FL2D-Z5-153		LH25 models	3.15A/250V, slow-blow, required

3. Application of Trim and calculation of Trim resistance



Applied circuits of Trim (Part in broken line is the interior of models)

Calculation formula of Trim resistance:

$$\text{up: } R_T = \frac{\alpha R_2}{R_2 - \alpha} - R_3 \quad \alpha = \frac{V_{ref}}{V_{ot} - V_{ref}} \cdot R_1$$

$$\text{down: } R_T = \frac{\alpha R_1}{R_1 - \alpha} - R_3 \quad \alpha = \frac{V_{ot} - V_{ref}}{V_{ref}} \cdot R_2$$

R_T is Trim resistance
 α is a self-defined parameter, with no real meaning.

V _{out}	R1(KΩ)	R2(KΩ)	R3(KΩ)	V _{ref} (V)	V _{ot} (V)
5V	3.3	3.3	1	2.5	Output voltage after regulation, variation ≤ ±10%
12V	3.83	1	1	2.5	
15V	7.5	1.5	1	2.5	
24V	8.66	1	1	2.5	

4. For more information, Please find the application note on www.mornsun-power.com

Dimensions and Recommended Layout

THIRD ANGLE PROJECTION

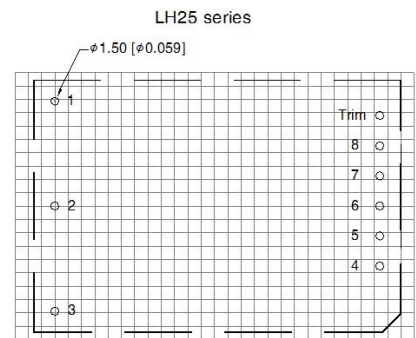
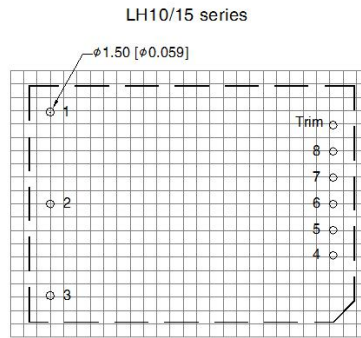
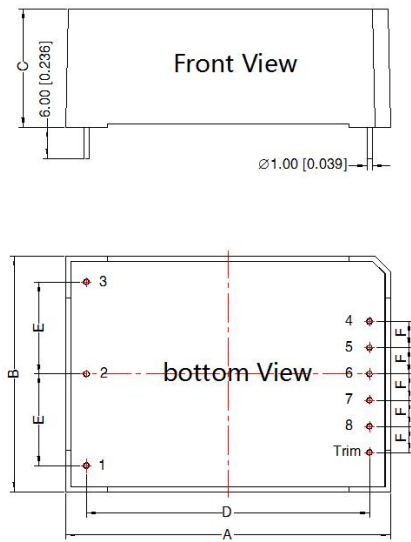

Note: Grid 2.54*2.54mm

Note:
Unit: mm[inch]
Pin diameter tolerances: $\pm 0.10[\pm 0.004]$
General tolerances: $\pm 0.50[\pm 0.020]$

OUTLINE AND DIMENSIONS (Unit: mm)			
NO.	LH10	LH15	LH25
A	62.00	62.00	70.00
B	45.00	45.00	48.00
C	30.00	30.00	30.00
D	54.00	54.00	62.00
E	17.50	17.50	20.00
F	5.00	5.00	5.75
G	12.50	12.50	12.50

MODLES WEIGHT:			
WEIGHT (Typ.)	LH10	LH15	LH25
	100g	100g	130g

FOOTPRINT DETAILS		
Pin	LHXX-10B	LHXX-10D
1		
2	AC(N)	AC(N)
3	AC(L)	AC(L)
4	-Vo	-Vo1
5	No Pin	+Vo1
6	No Pin	No Pin
7	No Pin	-Vo2
8	+Vo	+Vo2
Trim	Trim**	No Pin

Trim**: only for LH25-10BXXER2 Series.

A2 Dimensions

THIRD ANGLE PROJECTION

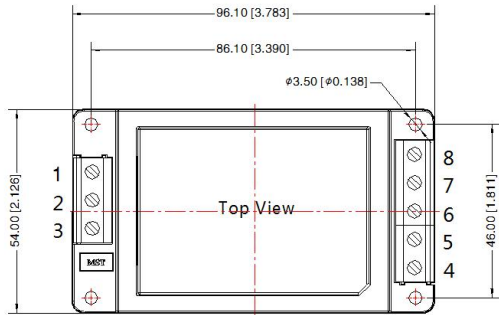

Pin	LHXX-10B	LHXX-10D
1	GND	GND
2	AC(N)	AC(N)
3	AC(L)	AC(L)
4	+Vo	+Vo2
5	NC	-Vo2
6	NC/Trim**	NC
7	NC	+Vo1
8	-Vo	-Vo1

NC/Trim** : The pin is Trim on LH25-10BXXER2A2 ,
The pin is not connected on other single output products.

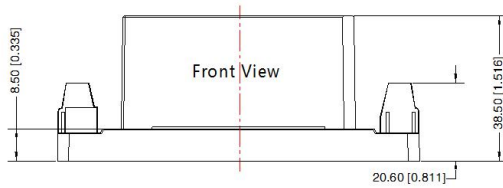

*The figure above is related to LH10ER2A2 series

Note:
Unit:mm[inch]
Wire range: 24-12 AWG
Tightening torque: Max 0.4 N · m
General tolerances: ± 0.50 [± 0.020]

MODELS WEIGHT			
WEIGHT	LH10	LH15	LH25
Typ.	150g	150g	180g

A4 Dimensions

THIRD ANGLE PROJECTION

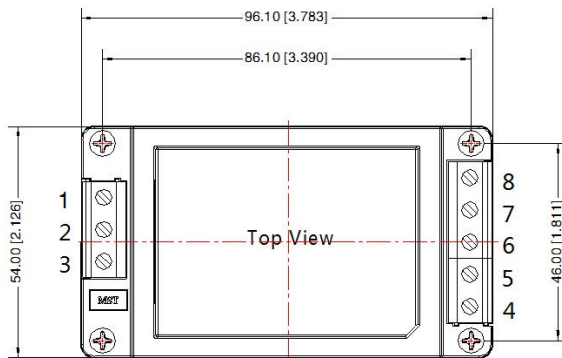

Pin	LHXX-10B	LHXX-10D
1	\perp	\perp
2	AC(N)	AC(N)
3	AC(L)	AC(L)
4	+Vo	+Vo2
5	NC	-Vo2
6	NC/Trim**	NC
7	NC	+Vo1
8	-Vo	-Vo1

NC/Trim** : The pin is Trim on LH25-10BXXER2A4 ,
The pin is not connected on other single output products.

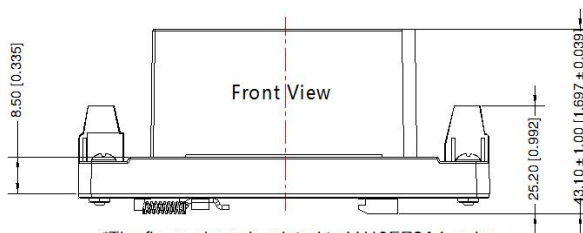

*The figure above is related to LH10ER2A4 series

Note:
Unit: mm[inch]
Wire range: 24-12 AWG
Tightening torque: Max 0.4 N · m
Mounting rail: TS35, rail needs to connect safety ground
General tolerances: ± 0.50 [± 0.020]

MODELS WEIGHT			
WEIGHT	LH10	LH15	LH25
Typ.	190g	190g	220g

Note:

1. For additional information on Product Packaging please refer to www.mornsun-power.com. Packaging bag number: 58220017; the Packing bag number of A2/A4 package: 58220019;
2. If the product is not operated within the required load range, the product performance cannot be guaranteed to comply with all parameters in the datasheet;
3. Unless otherwise specified, parameters in this datasheet were measured under the conditions of $T_a=25^{\circ}\text{C}$, humidity<75% with nominal input voltage and rated output load;
4. All index testing methods in this datasheet are based on our company corporate standards;
5. We can provide product customization service, please contact our technicians directly for specific information;
6. Products are related to laws and regulations: see "Features" and "EMC";
7. Our products shall be classified according to ISO14001 and related environmental laws and regulations, and shall be handled by qualified units.

Mornsun Guangzhou Science & Technology Co., Ltd.

Address: No. 5, Kehui St. 1, Kehui Development Center, Science Ave., Guangzhou Science City, Huangpu District, Guangzhou, P. R. China
Tel: 86-20-38601850 Fax: 86-20-38601272 E-mail: info@mornsun.cn www.mornsun-power.com