

Am27S43/27S43A

32,768-Bit (4096x8) Bipolar PROM



DISTINCTIVE CHARACTERISTICS

- Ultra-fast access time
- Voltage and temperature compensated providing extremely flat AC performance over military range
- Platinum-Silicide fuses guarantee high reliability, fast programming and exceptionally high programming yields (typ > 98%)

GENERAL DESCRIPTION

The Am27S43 (4096 words by 8 bits) is a Schottky TTL Programmable Read-Only Memory (PROM).

This device has three-state outputs compatible with low-power Schottky bus standards capable of satisfying the requirements of a variety of microprogrammable controls.

BLOCK DIAGRAM

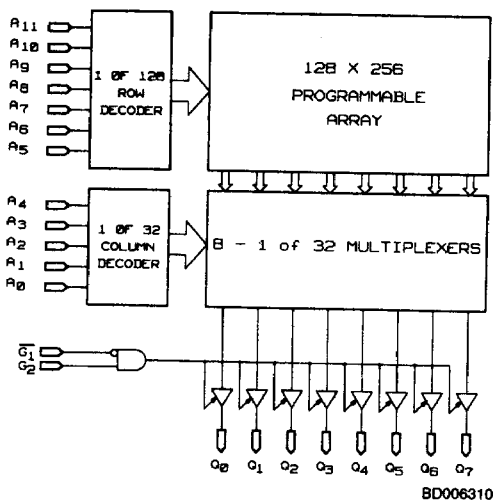

PRODUCT SELECTOR GUIDE

Part Number	Am27S43A		Am27S43	
	Address Access Time	Operating Range	Address Access Time	Operating Range
	40 ns	C	55 ns	C
	55 ns	M	65 ns	M

CONNECTION DIAGRAMS Top View

DIPs*

LCCs

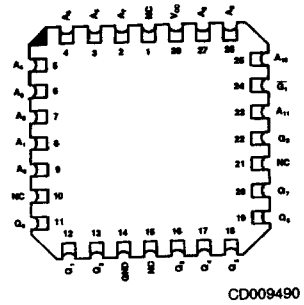
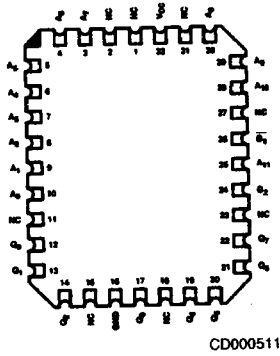
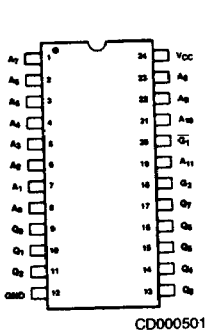

*Also available in 24-Pin Flatpack. Pinout identical to DIPs.

Note: Pin 1 is marked for orientation.

LOGIC SYMBOL

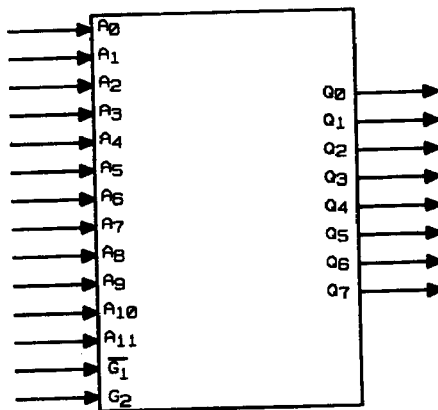

LS002401

ORDERING INFORMATION

Standard Products

AMD standard products are available in several packages and operating ranges. The order number (Valid Combination) is formed by a combination of:

- a. Device Number
- b. Speed Option (if applicable)
- c. Package Type
- d. Temperature Range
- e. Optional Processing
- f. Alternate Packaging Option

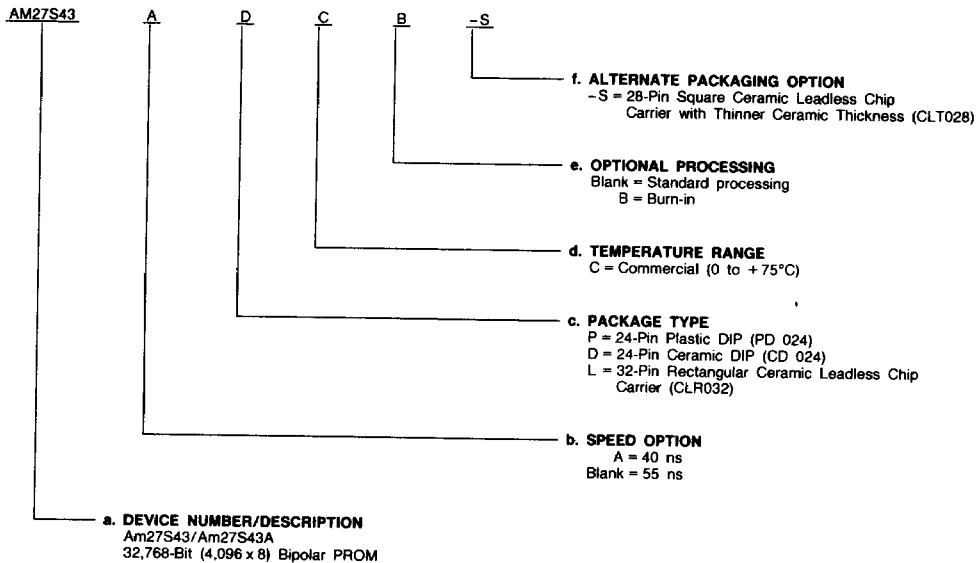

Valid Combinations	
AM27S43	DC, DCB, PC, PCB,
AM27S43A	LC, LCB, LC-S, LCB-S

Valid Combinations

Valid Combinations list configurations planned to be supported in volume for this device. Consult the local AMD sales office to confirm availability of specific valid combinations, to check on newly released combinations, and to obtain additional data on AMD's standard military grade products.

MILITARY ORDERING INFORMATION

APL Products

AMD products for Aerospace and Defense applications are available in several packages and operating ranges. APL (Approved Products List) products are fully compliant with MIL-STD-883C requirements. The order number (Valid Combination) for APL products is formed by a combination of:

- a. Device Number
- b. Speed Option (if applicable)
- c. Device Class
- d. Package Type
- e. Lead Finish

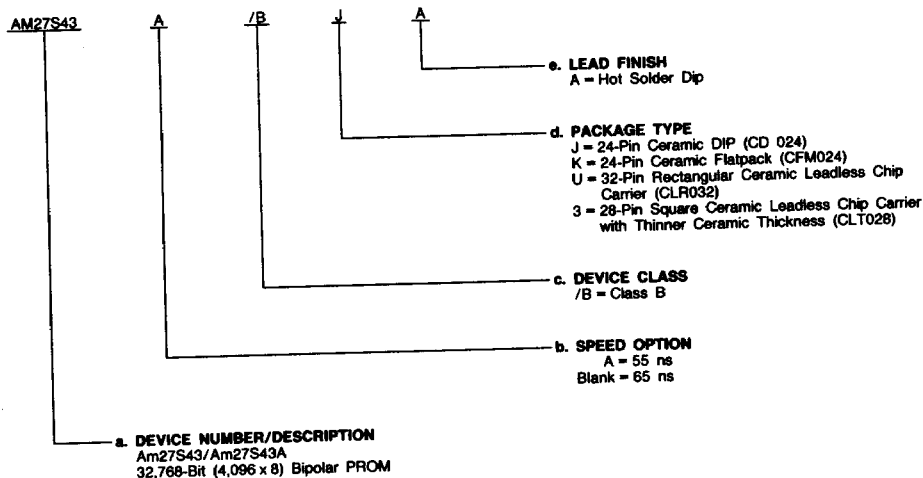

Valid Combinations	
AM27S43	/BJA, /BKA
AM27S43A	/BUA, /B3A

Valid Combinations

Valid Combinations list configurations planned to be supported in volume for this device. Consult the local AMD sales office to confirm availability of specific valid combinations or to check for newly released valid combinations.

Group A Tests

Group A tests consist of Subgroups 1, 2, 3, 7, 8, 9, 10, 11.

MILITARY BURN-IN

Military burn-in is in accordance with the current revision of MIL-STD-883, Test Method 1015, Conditions A through E. Test conditions are selected at AMD's option.

PIN DESCRIPTION

A₀ - A₁₁ Address (Inputs)

The 12-bit field presented at the address inputs selects one of 4,096 memory locations to be read from.

Q₀ - Q₇ Data Output Port

The outputs whose state represents the data read from the selected memory locations. These outputs are three-state buffers which when disabled are in a floating or high-impedance state.

$\overline{G}_1, \overline{G}_2$ Output Enable (Input)

Provides direct control of the Q-output, three-state buffers. Outputs disabled forces all outputs to a floating or high-impedance state.

$$\text{Enable} = \overline{G}_1 \cdot \overline{G}_2$$

$$\text{Disable} = \overline{G}_1 \cdot \overline{G}_2 = \overline{G}_1 \cdot \overline{G}_2$$

V_{CC} Device Power Supply Pin

The most positive of the logic power supply pins.

GND Device Power Supply Pin

The most negative of the logic power supply pins.

ABSOLUTE MAXIMUM RATINGS

Storage Temperature	-65 to +150°C
Ambient Temperature with Power Applied	-55 to +125°C
Supply Voltage	-0.5 V to +7.0 V
DC Voltage Applied to Outputs (Except During Programming)	-0.5 V to +V _{CC} Max.
DC Voltage Applied to Outputs During Programming	21 V
Output Current into Outputs During Programming (Max. Duration of 1 sec)	250 mA
DC Input Voltage	-0.5 V to +5.5 V
DC Input Current	-30 mA to +5 mA

Stresses above those listed under ABSOLUTE MAXIMUM RATINGS may cause permanent device failure. Functionality at or above these limits is not implied. Exposure to absolute maximum ratings for extended periods may affect device reliability.

OPERATING RANGES

Commercial (C) Devices	Ambient Temperature (T _A)	0 to +75°C
	Supply Voltage (V _{CC})	+4.75 V to +5.25 V
Military (M) Devices*	Case Temperature (T _C)	-55 to +125°C
	Supply Voltage (V _{CC})	+4.5 V to +5.5 V

Operating ranges define those limits between which the functionality of the device is guaranteed.

*Military Product 100% tested at T_C = +25°C, +125°C, and -55°C.

DC CHARACTERISTICS over operating ranges unless otherwise specified (for APL Products, Group A, Subgroups 1, 2, 3 are tested unless otherwise noted)

Parameter Symbol	Parameter Description	Test Conditions	Min.	Typ.	Max.	Unit
V _{OH}	Output HIGH Voltage	V _{CC} = Min., I _{OH} = -2.0 mA V _{IN} = V _{IH} or V _{IL}	2.4			V
V _{OL}	Output LOW Voltage	V _{CC} = Min., I _{OL} = 16 mA V _{IN} = V _{IH} or V _{IL}			0.50	V
V _{IH}	Input HIGH Level	Guaranteed input logical HIGH voltage for all inputs (Note 1)	2.0			V
V _{IL}	Input LOW Level	Guaranteed input logical LOW voltage for all inputs (Note 1)			0.8	V
I _{IL}	Input LOW Current	V _{CC} = Max., V _{IN} = 0.45 V			-0.250	mA
I _{IH}	Input HIGH Current	V _{CC} = Max., V _{IN} = V _{CC}			40	μA
I _{SC}	Output Short-Circuit Current	V _{CC} = Max., V _{OUT} = 0.0 V (Note 2)	-15		-100	mA
I _{CC}	Power Supply Current	All inputs = GND, V _{CC} = Max.			185	mA
		COM'L MIL			185	
V _I	Input Clamp Voltage	V _{CC} = Min., I _{IN} = -18 mA			-1.2	V
I _{CEX}	Output Leakage Current	V _{CC} = Max. V _{GT} = 2.4 V			40	μA
		V _O = V _{CC} V _O = 0.4 V			-40	
C _{IN}	Input Capacitance	V _{IN} = 2.0 V @ f = 1 MHz (Note 3) V _{CC} = 5 V, T _A = 25°C		5.0		pF
C _{OUT}	Output Capacitance	V _{OUT} = 2.0 V @ f = 1 MHz (Note 3) V _{CC} = 5 V, T _A = 25°C		8.0		

Notes: 1. V_{IL} and V_{IH} are input conditions of output tests and are not themselves directly tested. V_{IL} and V_{IH} are absolute voltages with respect to device ground and include all overshoots due to system and/or tester noise. Do not attempt to test these values without suitable equipment.

2. Not more than one output should be shorted at a time. Duration of the short-circuit test should not be more than one second.
3. These parameters are not 100% tested, but are evaluated at initial characterization and at any time the design is modified where capacitance may be affected.

SWITCHING CHARACTERISTICS over operating ranges unless otherwise specified (for APL Products, Group A, Subgroups 9, 10, 11 are tested unless otherwise noted*)

No.	Parameter Symbol	Parameter Description	Am27S43A				Am27S43				Unit
			COM'L		MIL		COM'L		MIL		
			Min.	Max.	Min.	Max.	Min.	Max.	Min.	Max.	
1	TAVQV	Address Valid to Output Valid Access Time		40		55		55		65	ns
2	TGVQZ	Delay from Output Enable Valid to Output Hi-Z		30		35		35		40	ns
3	TGVQV	Delay from Output Enable Valid to Output Valid		30		35		35		40	ns

Notes: 1. Tests are performed with input transition time of 5 ns or less, timing reference levels of 1.5 V, and input pulse levels of 0 to 3.0 V.

2. TGVQZ is measured at steady state HIGH output voltage -0.5 V and steady state LOW output voltage +0.5 V output levels.

*Subgroups 7 and 8 apply to functional tests.

SWITCHING TEST CIRCUIT

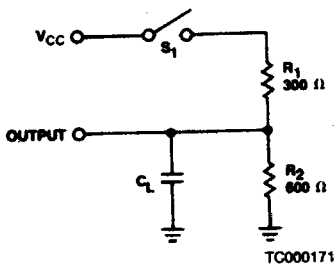

- Notes: 1. TAVQV is tested with Switch S_1 closed and $C_L = 30$ pF.
 2. For three-state outputs, TGVQV is tested with $C_L = 30$ pF to the 1.5 V level; S_1 is open for high-impedance to HIGH tests and closed for high-impedance to LOW tests. TGVQZ is tested with $C_L = 5$ pF. HIGH to high-impedance tests are made with S_1 open to an output voltage of $V_{OH} - 0.5$ V; LOW to high-impedance tests are made with S_1 closed to the $V_{OL} + 0.5$ V level.

SWITCHING WAVEFORMS

KEY TO SWITCHING WAVEFORMS

WAVEFORM	INPUTS	OUTPUTS
	MUST BE STEADY	WILL BE STEADY
	MAY CHANGE FROM H TO L	WILL BE CHANGING FROM H TO L
	MAY CHANGE FROM L TO H	WILL BE CHANGING FROM L TO H
	DON'T CARE: ANY CHANGE PERMITTED	CHANGING: STATE UNKNOWN
	DOES NOT APPLY	CENTER LINE IS HIGH IMPEDANCE "OFF" STATE

KS000010

