

1	2	3	4	5	6	7	8	9	10
SWITCH CIRCUIT			MATERIAL AND FINISH AS BELOW						
WHEN CARD IS EJECTED		WHEN CARD IS INSERTED		A	Housing	LCP UL94V-0 Black	E		
				B	Contact	Phosphor Bronze C5210, Contact Area: Gold Flash	F		
				C	Latch	Stainless Steel SUS301	G		
				D			H		

SPECIFICATION:

- ELECTRICAL**
 - Current Rating: 0.5A per pin
 - Voltage Rating: 25V AC/DC
 - Contact Resistance: 60mΩ
 - Insulation Resistance: 500MΩ
 - Dielectric Withstanding Voltage: 125VAC

- MECHANICAL**
 - Durability: 25 Cycle
 - Latch Retention Force: 8 N/Pos. Min

- ENVIRONMENTAL**
 - Operating temperature range: -40°C~+85°C
 - Storage temperature range: -40°C~+85°C

- SOLDER ABILITY**
 - Recommended IR Reflow Temperature: 255°C 10Sec

NOTES:
DATE CODE 2202 (YWWDD)
Y: 2 YEAR(2012)
WW:20 WEEK(01~52)
D: 2 DAY(01~07)

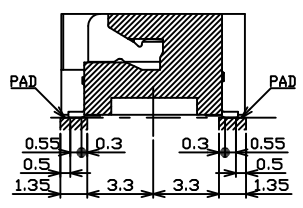
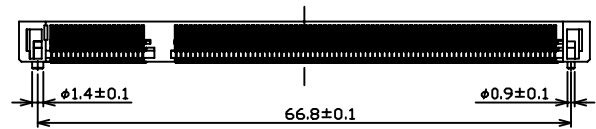
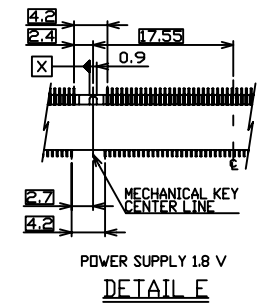
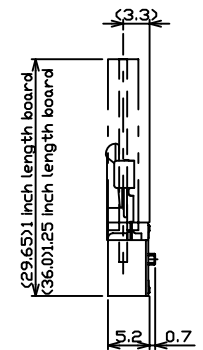
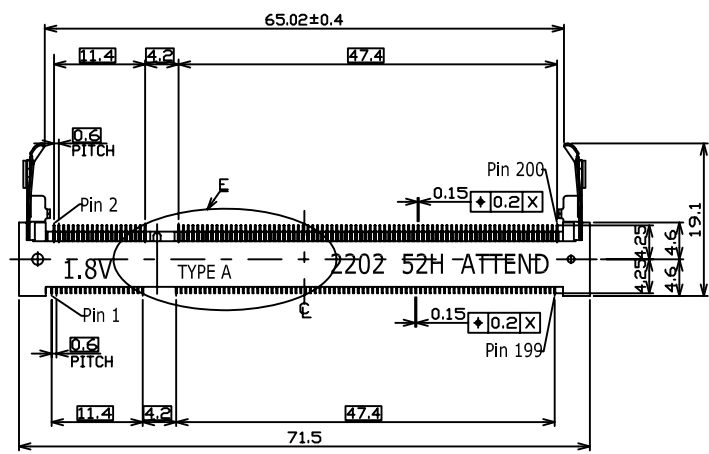
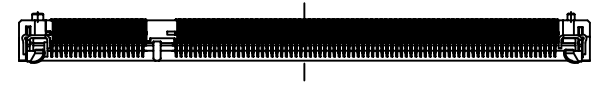

P1	P2	P3	P4	P5	P6	P7	P8	P9	P10	P11	P12
PIN ASSIGNMENT											
121A-52A00			SO DIMM DDR2 Socket 1.8V 200Pin Type 5.2H, Contact Area: Gold Flash								
PRODUCT NO.			DESCRIPTION								

UNLESS OTHERWISE SPECIFIED TOLERANCE			 www.attend.com.tw
ANGLES	ANG.	±5°	
LINEAR	0.	±0.3	
	0.0	±0.25	
	0.00	±0.20	
SCALE	AS SHOWN	UNIT: mm	
DRAWN	Willis	2012/12/05	DRAWN NAME:
CHECKED	Angel	2012/12/05	SO DIMM DDR2 Socket 1.8V 200Pin 5.2H Type
APPROVED	Ken	2012/12/05	PRODUCT NO.
			121A-52A00
REV.	DESCRIPTION	DATE	REV.
1	2	3	4
1	2	3	4

△ Revise:

△ Revise:

△ Revise:

REV.



SIZE A4 REV. 1.0

FILE NAME 121A-52A00_B_1

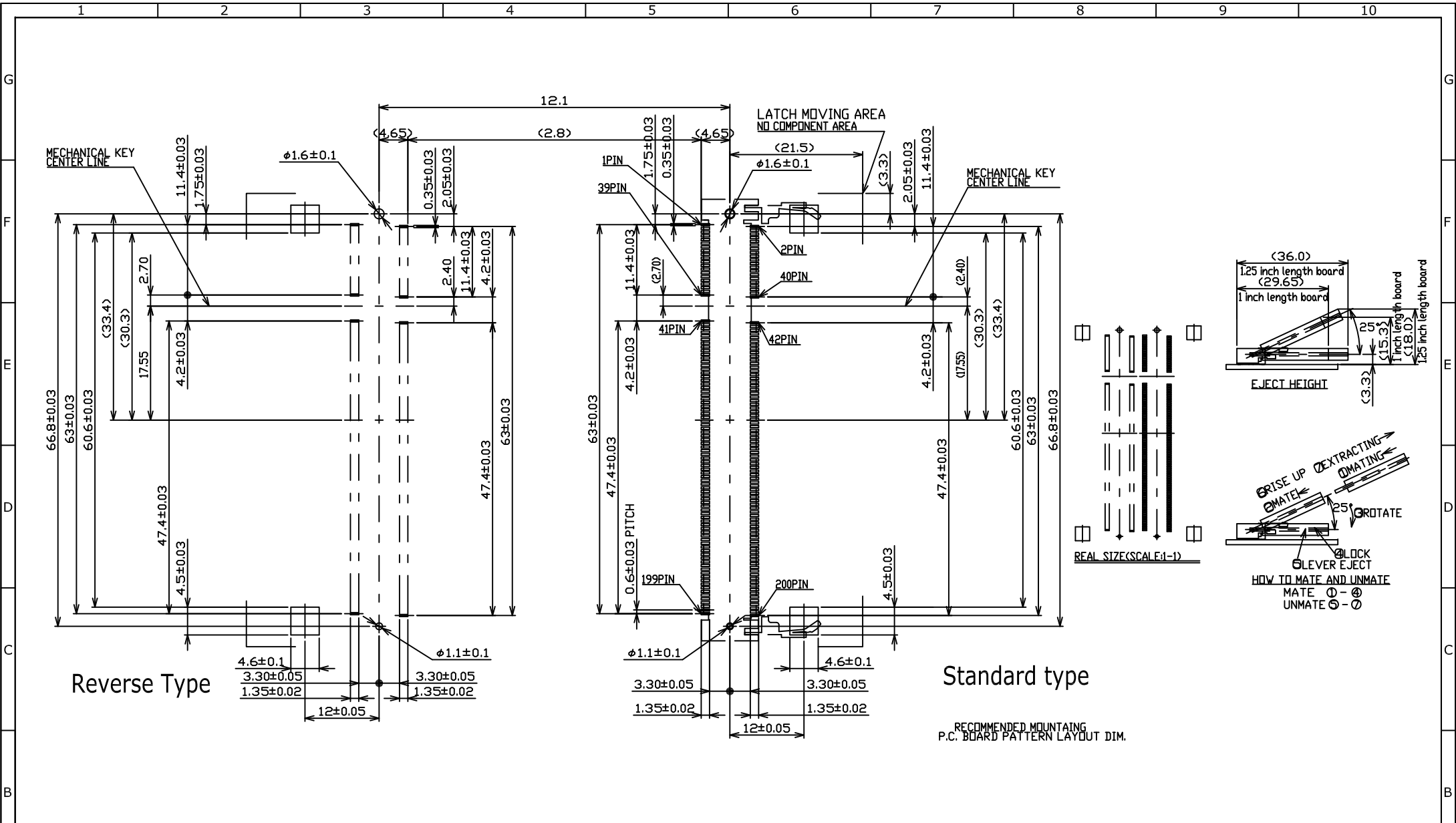

REV.	DESCRIPTION	DATE	REV.	DESCRIPTION	DATE	SIZE	REV.	FILE NAME
1			4			A4	1.0	121A-52A00_B_1
2			5					
3			6					
4			7					
5			8					
6			9					
7			10					

UNLESS OTHERWISE SPECIFIED TOLERANCE			ATTEND	
ANGLES	ANG.	±5°	www.attend.com.tw	
	0.	±0.3		
LINEAR	0.0	±0.25	DRAWN NAME: SO DIMM DDR2 Socket 1.8V 200Pin 5.2H Type	
	0.00	±0.20		
SCALE	AS SHOWN	UNIT: mm	DRAWN: Willis 2012/12/05 CHECKED: Angel 2012/12/05 APPROVED: Ken 2012/12/05	
DRAWN	Willis	2012/12/05		
CHECKED	Angel	2012/12/05		
APPROVED	Ken	2012/12/05	PRODUCT NO.	121A-52A00
			FILE NAME	121A-52A00_B_1

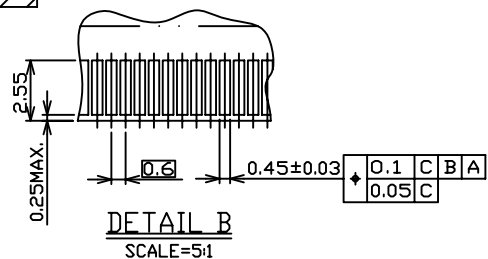
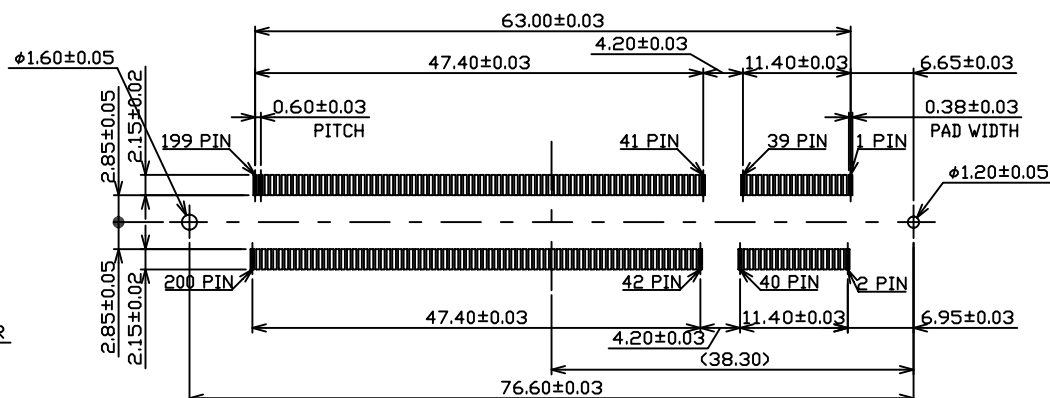
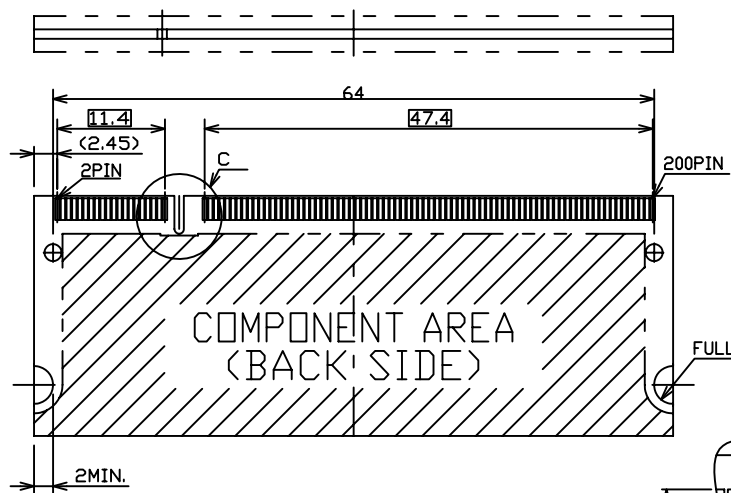
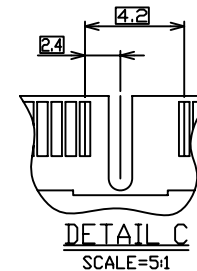
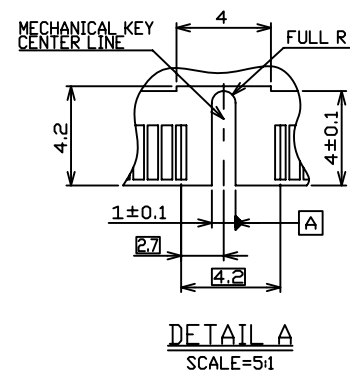
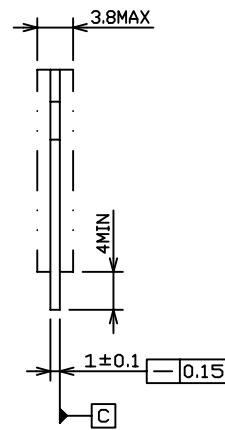
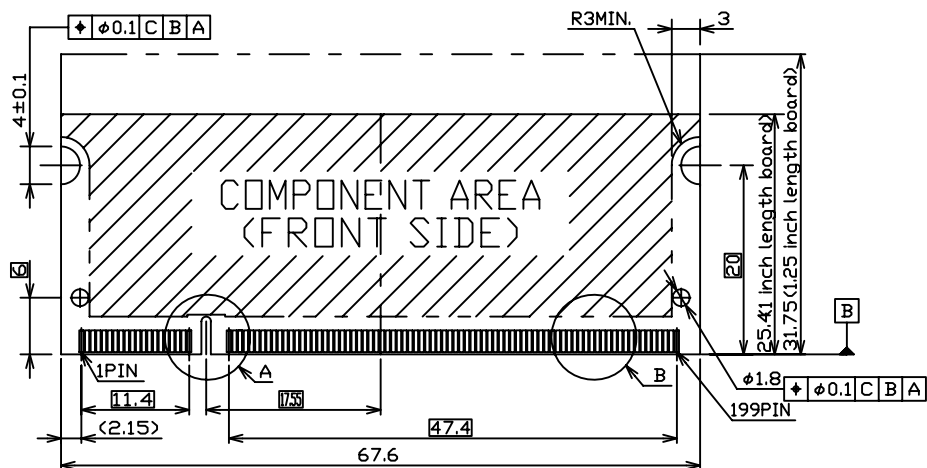

RECOMMENDED MOUNTING P.C. BOARD DIM.

RECOMMENDED MOUNTING P.C. BOARD PATTERN LAYOUT DIM.

UNLESS OTHERWISE SPECIFIED TOLERANCE		
ANGLES	ANG.	$\pm 5^\circ$
LINEAR	0.	± 0.3
	0.0	± 0.25
	0.00	± 0.20
SCALE	AS SHOWN	UNIT: mm
DRAWN	Willis	2012/12/05
CHECKED	Angel	2012/12/05
APPROVED	Ken	2012/12/05



www.attend.com.tw

DRAWN NAME: SO DIMM DDR2 Socket 1.8V 200Pin 5.2H Type

PRODUCT NO. 121A-52A00

FILE NAME 121A-52A00_B_1

REV.	DESCRIPTION	DATE	REV.	DESCRIPTION	DATE
1			2		
3			4		
5			6		
7			8		
9			10		

Revise:

Revise:

Revise:



SIZE A4

REV. 1.0

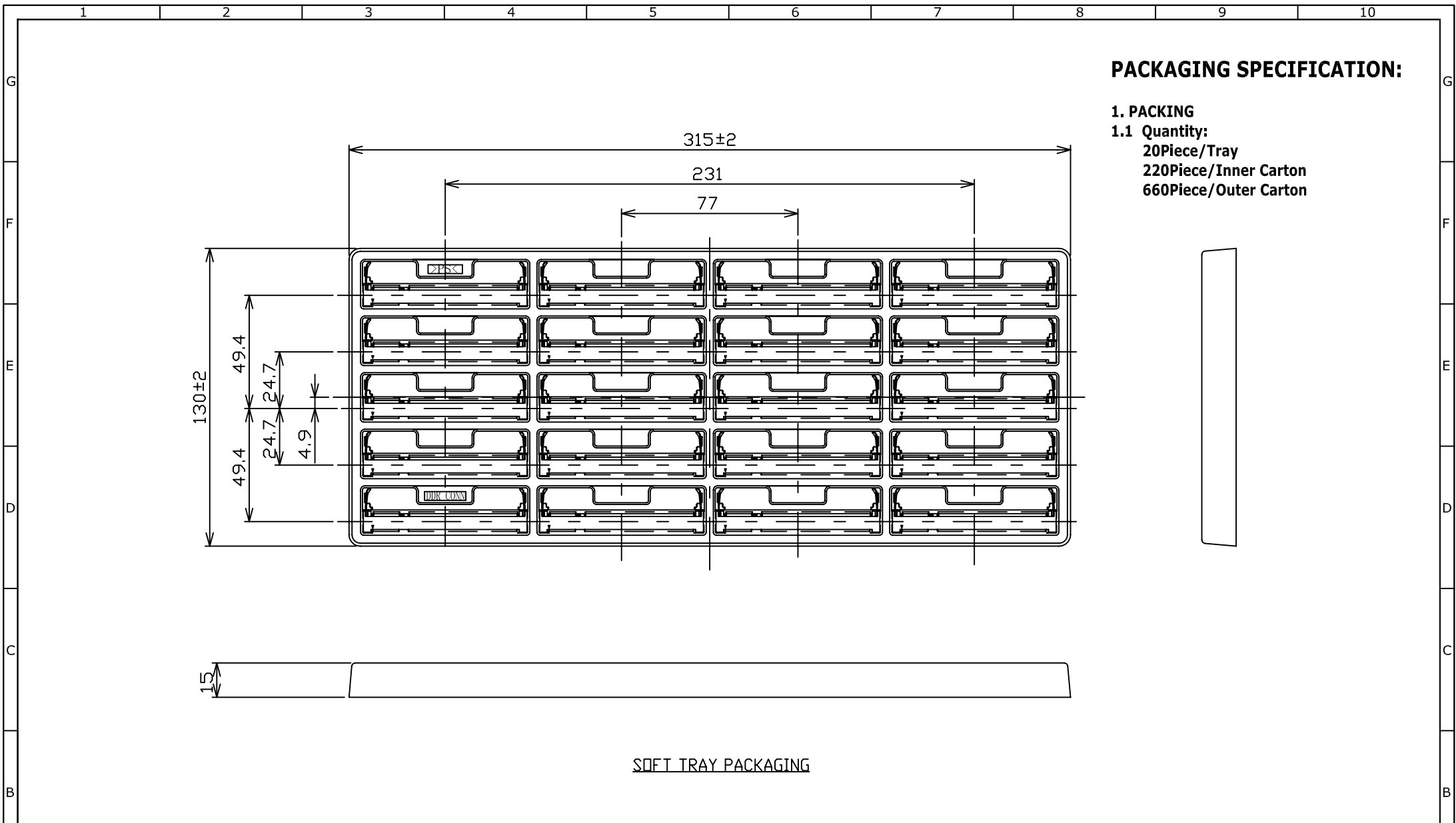

PACKAGING SPECIFICATION:

1. PACKING

- 1.1 Quantity:**
- 20Piece/Tray**
- 220Piece/Inner Carton**
- 660Piece/Outer Carton**

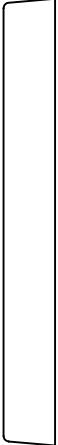

SOFT TRAY PACKAGING

						UNLESS OTHERWISE SPECIFIED TOLERANCE			 www.attend.com.tw	
						ANGLES	ANG.	±5°		
						LINEAR	0.	±0.3		
							0.00	±0.25		
						SCALE	AS SHOWN	UNIT: mm	±0.20	
						DRAWN	Willis	2012/12/05	DRAWN NAME:	
						CHECKED	Angel	2012/12/05	SO DIMM DDR2 Socket 1.8V 200Pin 5.2H Type	
						APPROVED	Ken	2012/12/05	PRODUCT NO.	121A-52A00
REV.	DESCRIPTION		DATE	REV.	DESCRIPTION		DATE	SIZE	REV.	FILE NAME
1				4				A4	1.0	121A-52A00_D_1

A

A