



# American Opto Plus LED Corp.

## L233LWD-TR

2.8 x 1.2 x 0.8 Right Angle White SMD, Tape and Reel

### PACKAGE OUTLINES

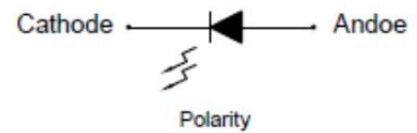
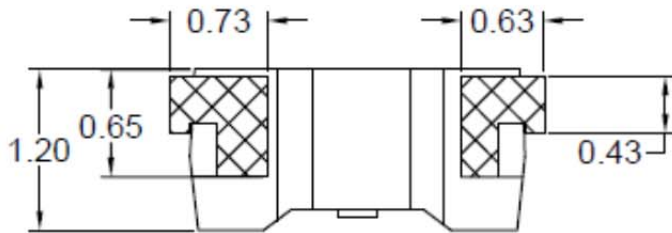
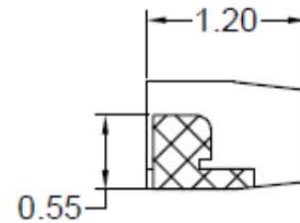
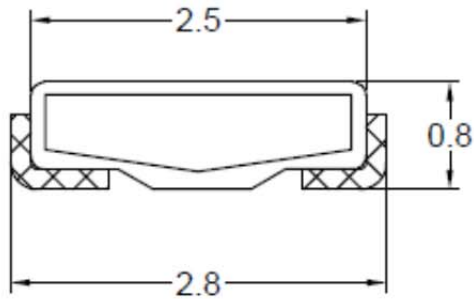

### RECOMMEND PAD LAYOUT

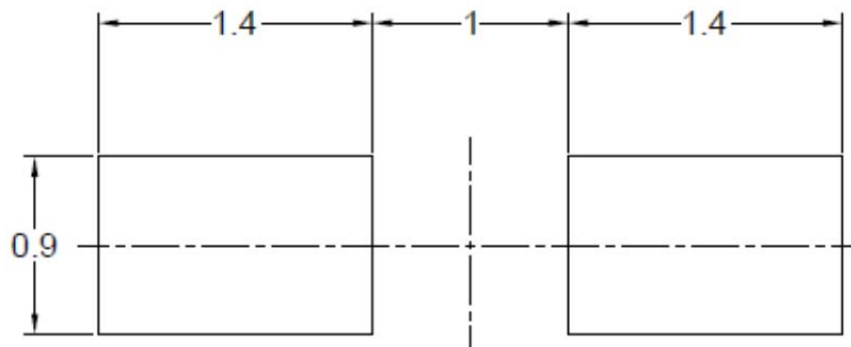

### NOTES:

1. All dimensions are in millimeters tolerance is  $\pm 0.1$  mm unless otherwise noted; Angle  $\pm 0.5$ . Unit=mm.



# American Opto Plus LED Corp.

## L233LWD-TR

2.8 x 1.2 x 0.8 Right Angle White SMD, Tape and Reel

Part Number	Material	Lens Color	
		Emitted	Lens
L233LWD-TR	InGaN/GaN	White	Yellow Diffused

### ABSOLUTE MAXIMUM RATINGS

(Ta=25°C)

Parameter	Symbol	Ratings	Unit
Power Dissipation	PD	120	mW
Peak Forward Current (Duty 1/10@10KHz)	I <sub>fp</sub>	100	mA
Forward Current	I <sub>f</sub>	30	mA
Reverse Current @ 5V	I <sub>r</sub>	50	μA
Electrostatic Discharge	ESD	500	V
Operating temperature range	T <sub>opr</sub>	-40~+80	°C
Storage temperature range	T <sub>stg</sub>	-40~+100	°C

### OPTICAL-ELECTRICAL CHARACTERISTICS

(Ta=25°C)

Parameter	Symbol	Test Condition	Min	Typ	Max	Unit
Luminous Intensity	I <sub>v</sub>	I <sub>F</sub> =20mA	1600	1900	--	mcd
Chromaticity Coordinates	X		0.287	--	0.311	--
	Y		0.276	--	0.315	--
Forward Voltage	V <sub>f</sub>		2.8	--	3.6	V
Viewing angle	2θ ½		--	115	--	Deg

- Note: 1. The forward voltage data did not include ±0.1V testing tolerance.  
 2. The luminous intensity data did not include ±15% testing tolerance.  
 3. The color coordinates measurement allowance is ±0.01 testing tolerance.



# American Opto Plus LED Corp.

## L233LWD-TR

2.8 x 1.2 x 0.8 Right Angle White SMD, Tape and Reel

### LUMINOUS INTENSITY CLASSIFICATION

BIN CODE	Iv(mcd) @ 20mA	
	Min.	Max.
W25W31	1600	1700
W32W33	1700	1800
W34W35	1800	1900
W36W37	1900	2000
X11X12	2000	2100

### FORWARD VOLTAGE CLASSIFICATION

BIN CODE	Vf(V) @ 20mA	
	Min.	Max.
1	2.8	2.9
2	2.9	3.0
3	3.0	3.1
4	3.1	3.2
5	3.2	3.3
6	3.3	3.4
7	3.4	3.5
8	3.5	3.6



# American Opto Plus LED Corp.

## L233LWD-TR

2.8 x 1.2 x 0.8 Right Angle White SMD, Tape and Reel

### CHROMATICITY COORDINATES SPECIFICATIONS FOR BIN GRADING

Color Coordiante at 20mA								
CODE	1		2		3		4	
	X	Y	X	Y	X	Y	X	Y
B61	0.3070	0.3150	0.3090	0.3050	0.3190	0.3160	0.3190	0.3270
B62	0.3090	0.3050	0.3110	0.2940	0.3200	0.3050	0.3190	0.3160
B63	0.3190	0.3270	0.3190	0.3160	0.3300	0.3290	0.3300	0.3390
B64	0.3190	0.3160	0.3200	0.3050	0.3300	0.3180	0.3300	0.3290

### CIE CHROMATICITY DIAGRAM

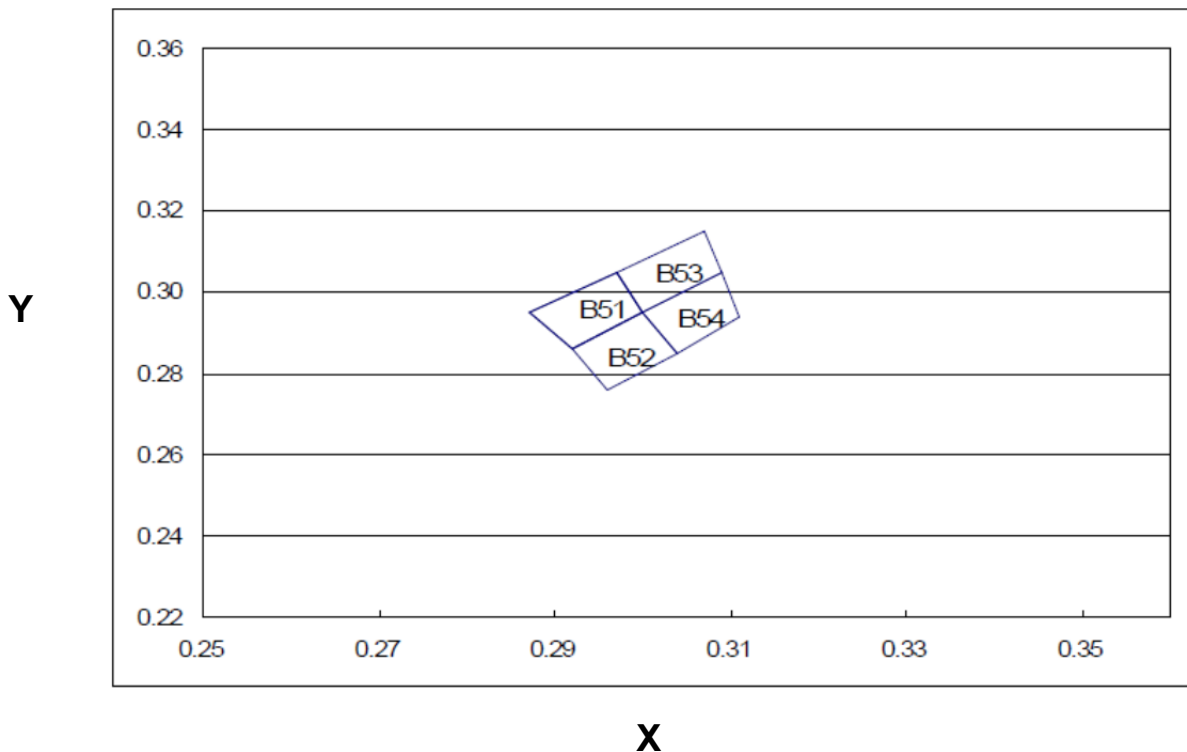



# American Opto Plus LED Corp.

## L233LWD-TR

2.8 x 1.2 x 0.8 Right Angle White SMD, Tape and Reel

### TYPICAL ELECTRO-OPTICAL CHARACTERISTIC CURVES

Fig.1 Forward current vs. Forward Voltage

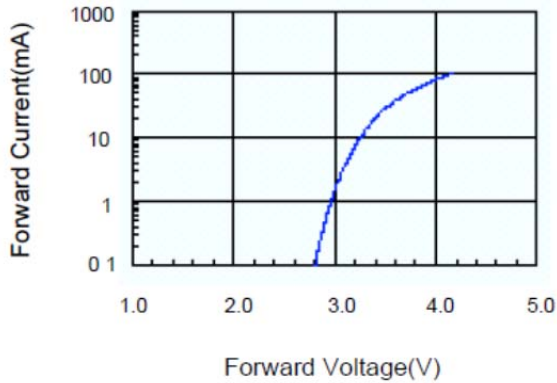

Fig.2 Relative Intensity vs. Forward Current

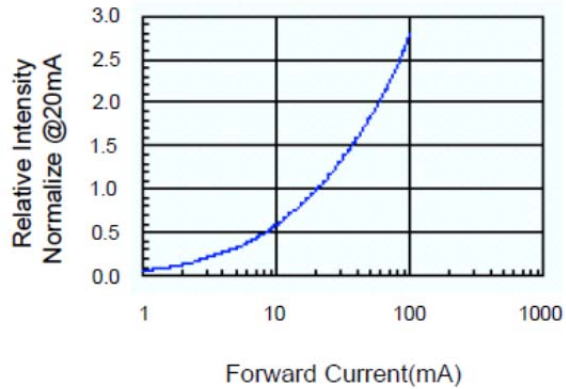

Fig.3 Forward Voltage vs. Temperature

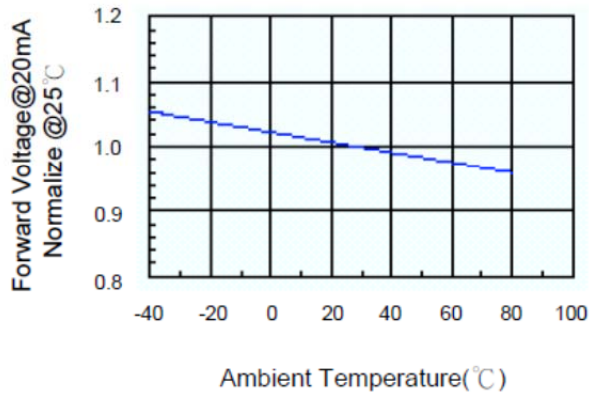

Fig.4 Relative Intensity vs. Temperature

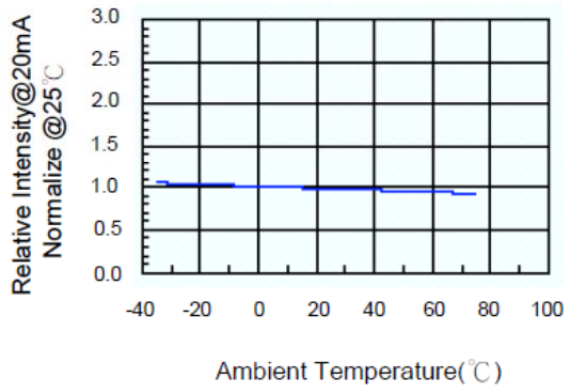

Fig.5 Luminous Spectrum(Ta=25°C)

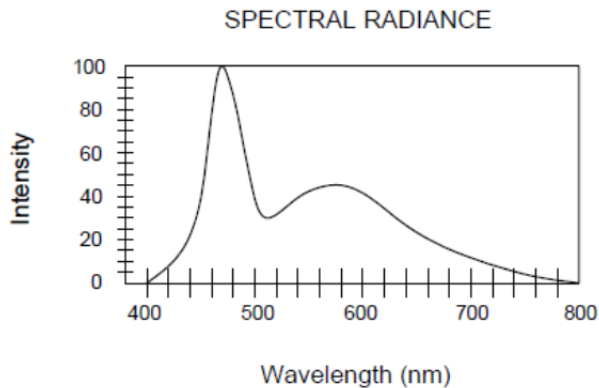
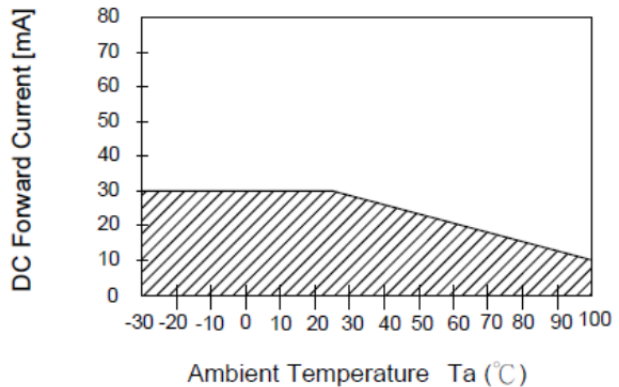

Fig.6 Forward Current vs. Temperature





# American Opto Plus LED Corp. L233LWD-TR

2.8 x 1.2 x 0.8 Right Angle White SMD, Tape and Reel

## CARRIER TAPE DIMENSION

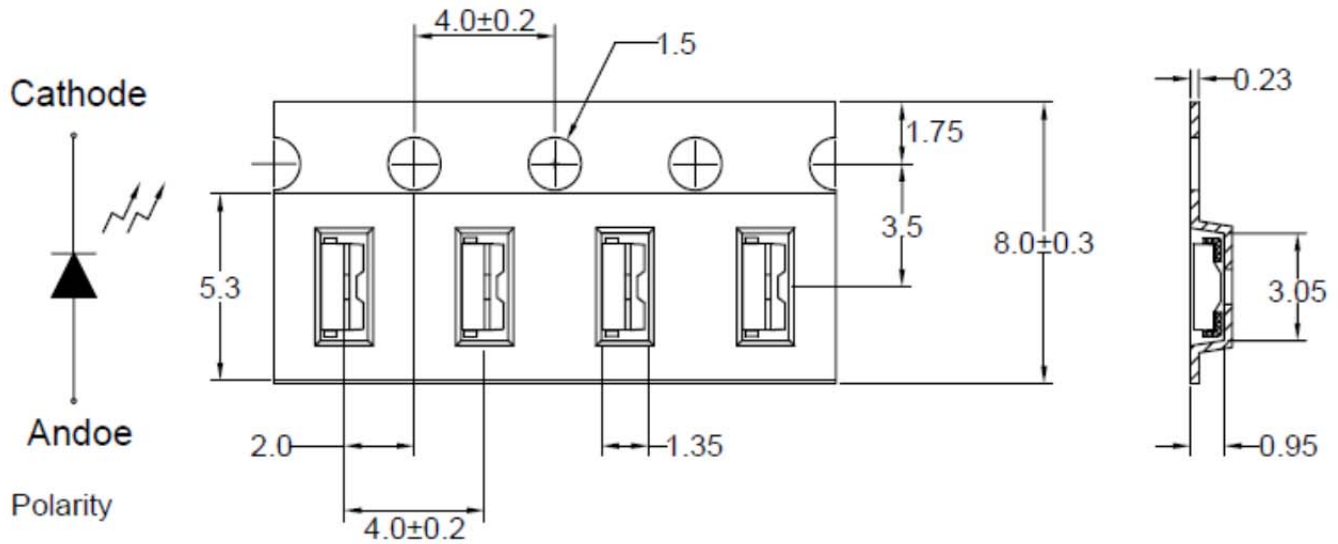

Note: The tolerances unless mentioned are  $\pm 0.1$ mm, Angle  $\pm 0.5$ ; Unit=mm

## REEL DIMENSIONS

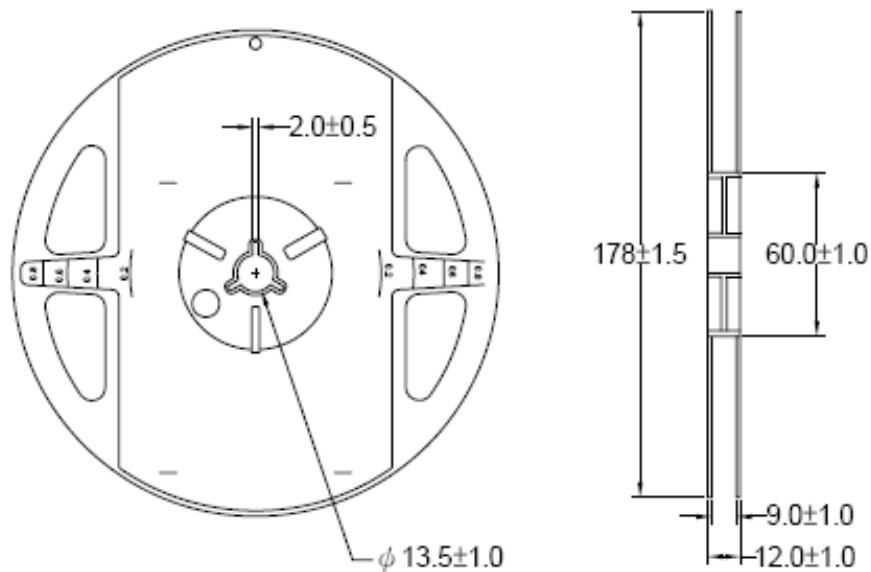

Notes:

1. 3000 pieces per reel.



# American Opto Plus LED Corp.

## L233LWD-TR

2.8 x 1.2 x 0.8 Right Angle White SMD, Tape and Reel

### RECOMMENDED SOLDERING CONDITIONS

#### 1. Hand Solder

Basic spec is  $\leq 280^{\circ}\text{C}$  3 sec one time only.

#### 2. Wave Solder

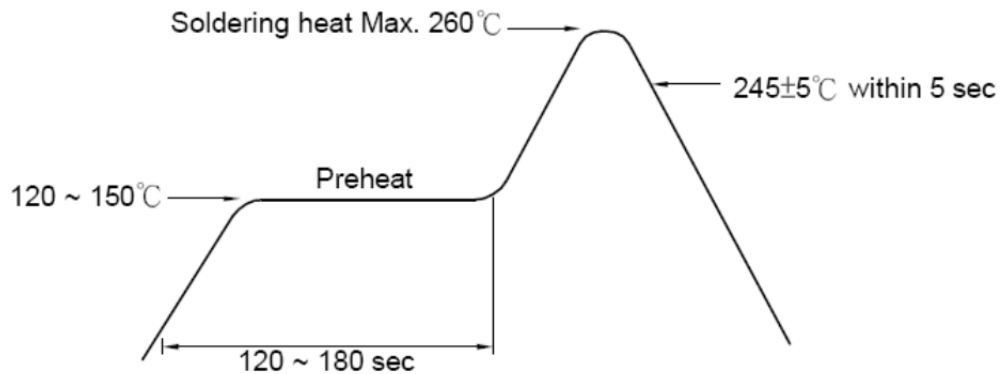

#### 3. PB-Free Reflow Solder

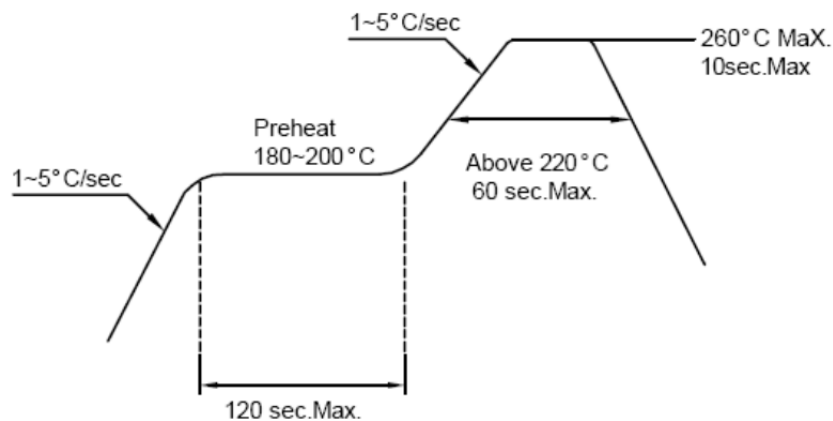

#### Notes:

1. Reflow soldering should not be done more than two times.
2. When soldering, do not put stress on the LEDs during heating.
3. After soldering, do not warp the circuit board.



# American Opto Plus LED Corp.

## L233LWD-TR

2.8 x 1.2 x 0.8 Right Angle White SMD, Tape and Reel

### PRECAUTIONS FOR USE

#### Storage Time:

1. The operation of temperatures and RH are: 5°C~35°C, RH60%.
2. Once the package is opened, the products should be used within a week. Otherwise, they should be kept in a damp proof box with desiccating agent. Considering the tape life, we suggest our customers to use our products within a year (from production date).
3. If opened more than one week in an atmosphere 5°C~35°C, RH60%, they should be treated at 60°C±5°C for 15hrs.

#### Drive Method:

LED is a current operated device, and therefore, require some kind of current limiting incorporated into the driver circuit. This current limiting typically takes the form of a current limiting resistor placed in a series with the LED.

Consider worst case voltage variations that could occur across the current limiting resistor. The forward current should not be allowed to change by more than 40% of its desired value.

Circuit model A

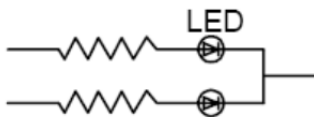

Circuit model B

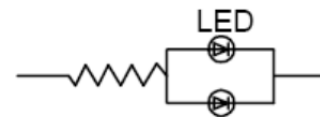

(A) Recommended circuit.

(B) The difference of brightness between LED could be found due to the VF-IF characteristics of LED.

#### Cleaning:

Use alcohol-based cleaning solvents such as isopropyl alcohol to clean the LED.

#### ESD(Electrostatic Discharge):

Static Electricity or power surge will damage the LED. Use of a conductive wrist band or anti-electrostatic glove is recommended when handling these LEDs. All devices and machinery must be properly grounded.





# American Opto Plus LED Corp.

## L233LWD-TR

2.8 x 1.2 x 0.8 Right Angle White SMD, Tape and Reel

### RELIABILITY TEST:

(1) Test items and results

Classification	Test Item	Test Conditions	Number of Damaged
<b>Endurance Test</b>	Operating Life Test	1. Ta=under room temperature as per data sheet maximum rating 2. If=20mA 3. t=1000 hrs	0/22
	High Temperature Storage Test	1. Ta=105°C±5°C 2. t=500 hrs	0/22
	Low Temperature Storage Test	1. Ta=40°C±5°C 2. t=1000 hrs	0/22
	High Temperature High Humidity Storage Test	1. IR-Reflow in-board, 2 times 2. Ta=85°C±5°C 3. RH=90%~95% 4. t=500hrs±2hrs	0/22
<b>Environmental Test</b>	Thermal Shock Test	1. IR-Reflow in-board, 2 times 2. Ta=105°C±5°C & -40°C±5°C (30min) (30min) 3. Total 100 cycles	0/22
	Reflow Soldering Test	1. T <sub>sol</sub> =260°C±5°C 2. Dwell time = 10 max	0/22
	Temperature Cycling	1. 105°C ~ 25°C ~ -40°C 30 mins 15 mins 30 mins 2. 100 cycles	0/22

(2) Criteria for judging the damage

Item	Symbol	Test Conditions	Criteria for Judgement	
			Min.	Max.
Forward Voltage	V <sub>f</sub>	If=20mA	--	U.S.L. x 1.2
Reverse Current	I <sub>r</sub>	V <sub>r</sub> =5V	--	U.S.L. x 2.0
Luminous Intensity	I <sub>v</sub>	If=20mA	L.S.L. x 0.5	--

Note:

1. U.S.L.: Upper Standard Level.      2. L.S.L: Lower Standard Level