



American Opto Plus LED Corp.

L515UWC-2700K

1.5 x 1.5 x 1.4 mm Warm White SMD LED

PACKAGE OUTLINES

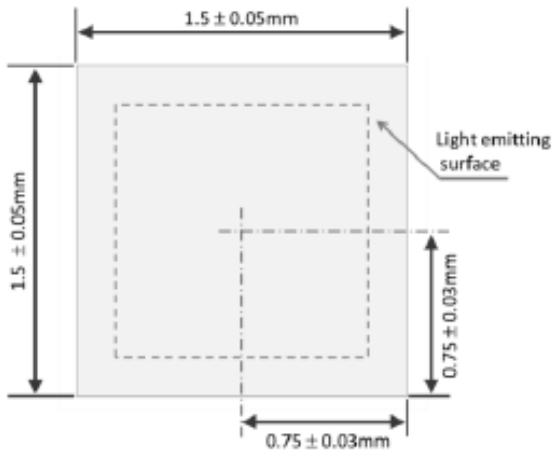

Top View

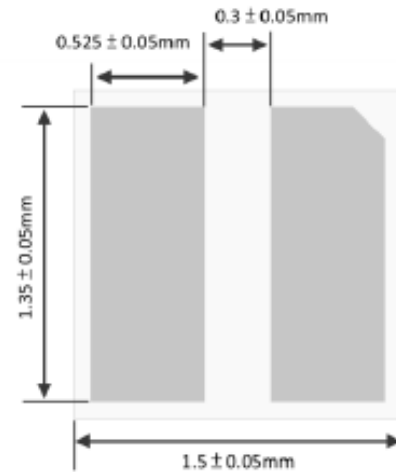

Bottom View

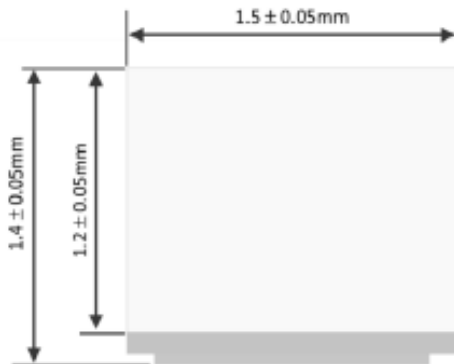

Side View

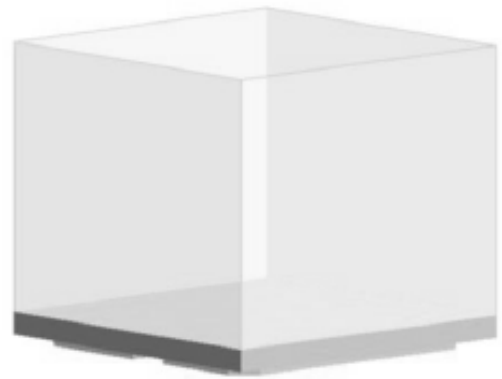

Notes:

1. All dimensions are in millimeters (inches);
2. Tolerances unless mentioned are $\pm 0.1\text{mm}$



American Opto Plus LED Corp.

L515UWC-2700K

1.5 x 1.5 x 1.4 mm Warm White SMD LED

RECOMMENDED SOLDERING PAD PATTERN



Top View

Recommended PCB Solder Pads

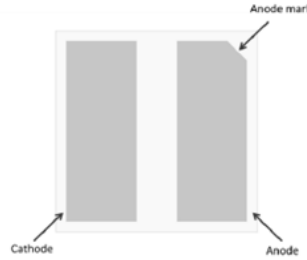

Bottom View

Recommended Stencil Pattern

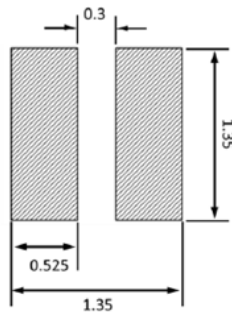

RECOMMENDED PCB SOLDER PAD

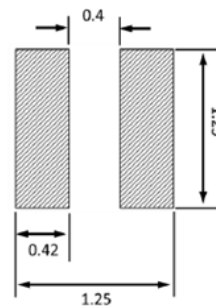

RECOMMENDED STENCIL PATTERN
(HATCHED AREA IS OPENING)

RECOMMENDED TRACE LAYOUT ON MCPCB

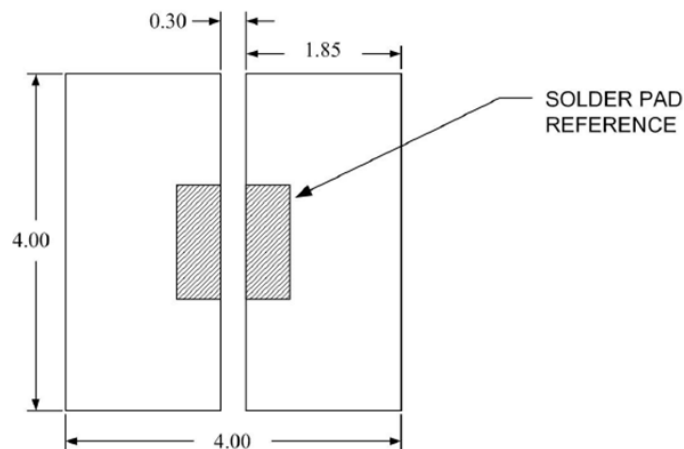

Recommended trace layout: MCPCB

Notes:

1. All dimensions are in millimeters.
2. Tolerances unless mentioned are ± 0.1 mm.



American Opto Plus LED Corp.

L515UWC-2700K

1.5 x 1.5 x 1.4 mm Warm White SMD LED

ABSOLUTE MAXIMUM RATINGS

(Ta=25°C)

Parameter	Symbol	Max Rating	Unit
Typ. Forward Current	I _F	350	mA
Max. Forward Current	I _F	1000	mA
Max. Peak Pulse Current	I _{PULSE}	1500	mA
Reverse Current	V	5	V
Power Dissipation (@350mA)	P _D	1.05 (typ)	W
Junction Temperature	T _J	150	°C
Operating Temperature	T _{OPR}	-40 ~ +85	°C
Storage Temperature	T _{STG}	-40 ~ +100	°C
Recommended Soldering Temperature	T _{SOL}	240	°C
Thermal Resistance	θ _{th}	4	°C/W
Allowable Reflow Cycles	-	3	Cycles
ESD Sensitivity	HBM	±8000	V

OPTICAL-ELECTRICAL CHARACTERISTICS

Parameter	Symbol	Test Condition	Min	Typ	Max	Unit
Luminous Flux	Φ _V	I _F =350mA	--	100	--	lm
Correlated Color Temperature	CCT		2580	2700	2870	K
Forward Voltage	V _F		--	3.0	--	V
Viewing Angle	2θ _{1/2}		--	155	--	deg
CRI	R _A		--	80	--	--
Thermal Resistance	Rθ _{J-C}		--	4	--	°C/W

Notes:

1. Luminous flux and power measurement tolerance is ± 7%
2. CRI measurement tolerance is ±3.
3. Viewing angle tolerance is ± 10°.



American Opto Plus LED Corp.

L515UWC-2700K

1.5 x 1.5 x 1.4 mm Warm White SMD LED

OPTICAL AND ELECTRICAL CHARACTERISTIC CURVES

Nominal 3000K, 4000K and 5700K - Board Temperature = 25°C

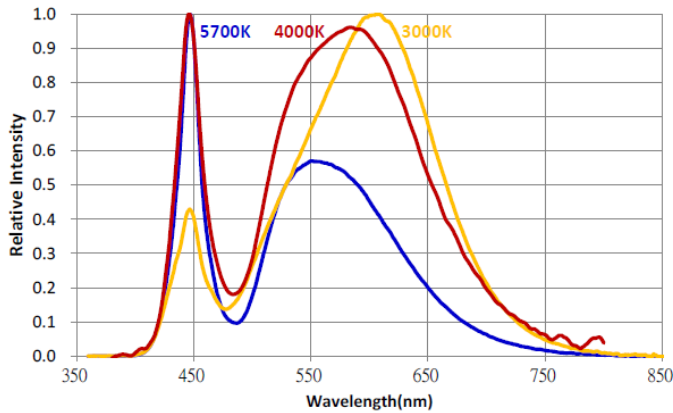

Typical Radiation Patterns

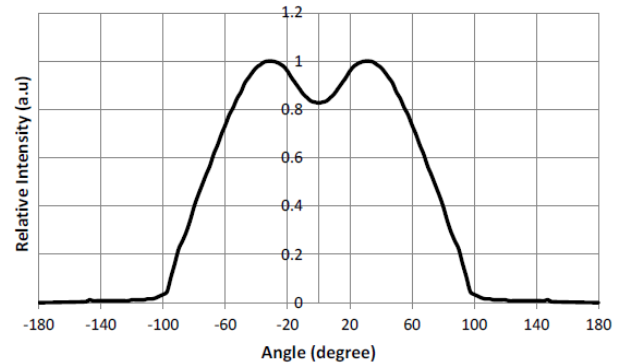

Forward Voltage vs. Board Temperature @350mA

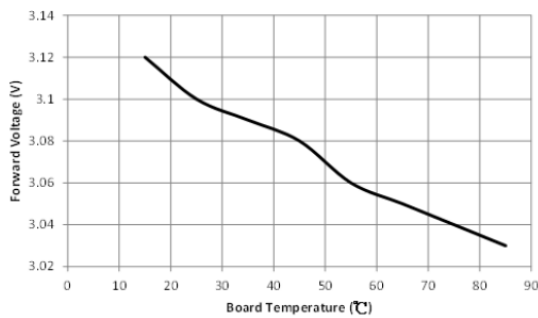

Typical Forward Current Characteristics

Board Temperature = 25°C

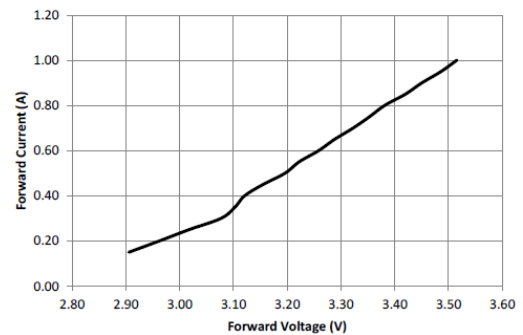

Relative Luminous Flux vs. Board Temperature @350mA

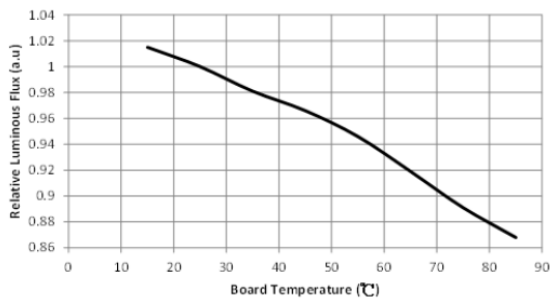

Typical Relative Luminous Flux vs. Forward Current

Board Temperature = 25°C

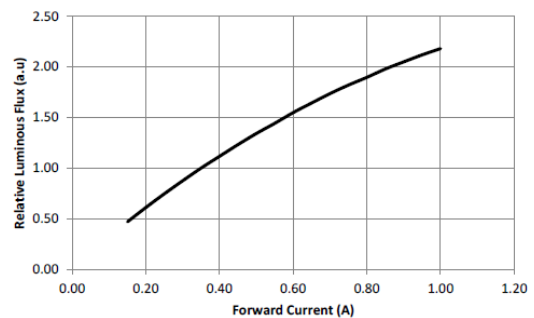



American Opto Plus LED Corp.

L515UWC-2700K

1.5 x 1.5 x 1.4 mm Warm White SMD LED

REFLOW SOLDERING CHARACTERISTICS

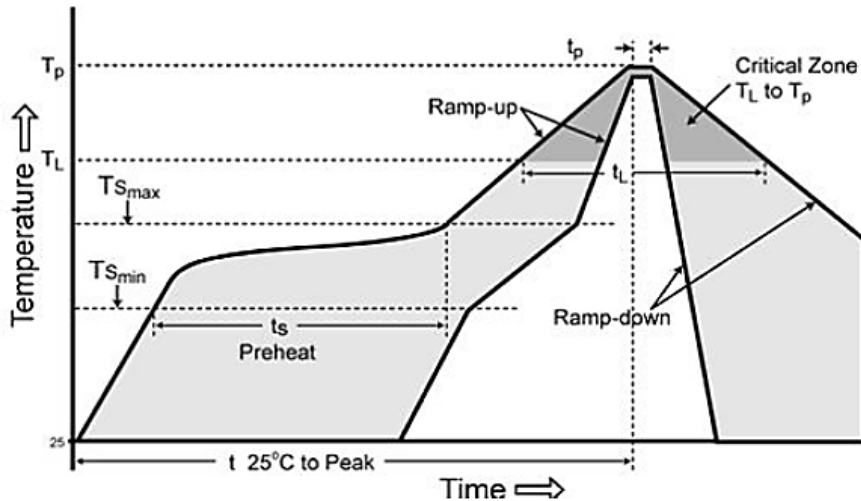

Profile Feature	Pb-Free Assembly
Average ramp-up rate (TL to TP)	3°C/second max
Preheat	
Temperature Min ($T_{S_{MIN}}$)	150°C
Temperature Max ($T_{S_{MAX}}$)	200°C
Time (min to max) (t_s)	60-180 seconds
Time maintained above:	
Temperature (TL)	217°C
Time (tL)	60-150 seconds
Peak/Classification Temperature (Tp)	240°C
Time within 5°C of actual Peak Temperature (tp)	20-40 seconds
Ramp-down rate	6°C/second max
Time 25°C to Peak Temperature	8 minutes max

