

Closed Barrier type terminal block

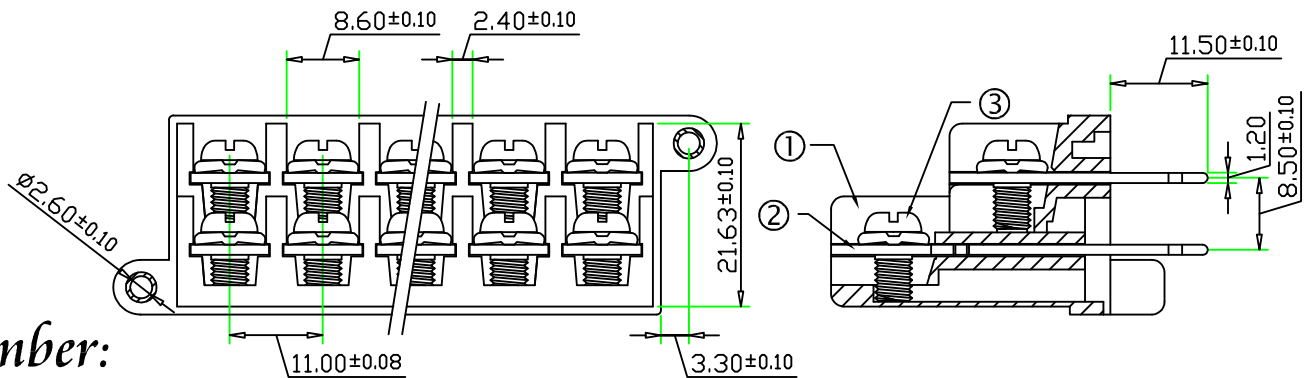
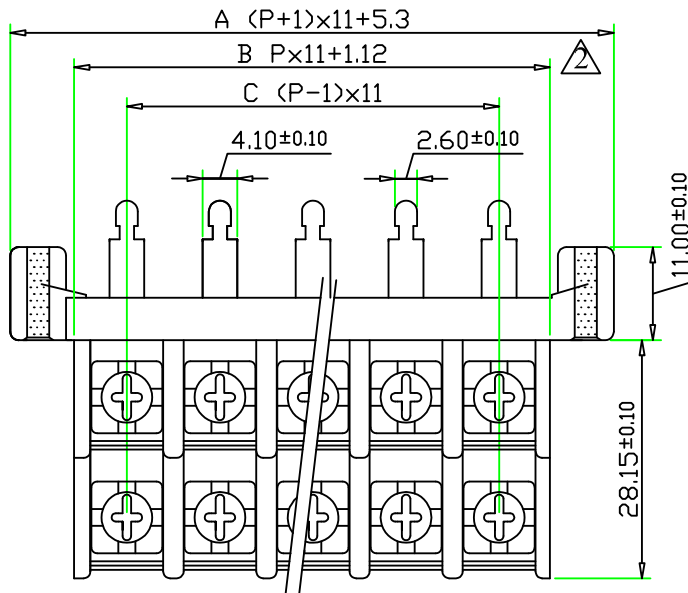

Part Number:

HD-347-PH

Pole Size 2~12P

SPECIFICATIONS

- ① Housing Material: Polyamide 66(UL94V-0), Black
- ② Screw: M4.0 Gold Plated Steel
- ③ Terminals: Gold Plated Brass

Screws Torque: 15 In-Lb

Wire Range: 10~18 AWG

Rated: 30 Amperes.AC300V

Operation Temperature: $-55^{\circ}\text{C} \sim +105^{\circ}\text{C}$

Insulation withstands volt: AC2000V min

Insulation resistance: $>1000\text{M}\Omega$ or more at DC500V