

CHT-LDOP Datasheet

Version: 02.1
10-Nov-10
(Last Modification Date)

High-Temperature, 1A, Low-Dropout Voltage Regulator

2.5V, 3.3V, 5V, 5.5V, 9V, 10V, 12V, 13V or 15V

General Description

The CHT-LDOP is a 1A, low-dropout linear voltage regulator compatible with high-temperature environments. Typical operation temperature range extends from -50°C to 225°C.

The circuit is stable throughout the whole temperature range and under a large choice of capacitive loads.

The minimum dropout voltage ($V_{in}-V_{out}$) is 2V with a 1A load current at 225°C and 1V for load currents lower than 400mA. The dropout voltage can span from 1 Volts to 20 Volts⁽¹⁾.

The circuit is a one-die solution.

CHT-LDOP is available as die or packaged devices (currently TO-3 and TO-254) on demand.

Related documents:

- **AN-06016:** "Selecting correct CISSOID regulator depending on your application"
- **AN-06002:** "Voltage regulator short-circuit protection and associated potential startup problem".
- **AN-090477:** "Power Dissipation Considerations During Short Circuit Conditions"

Applications

Power supplies for high-temperature electronic systems used in Well logging, Automotive, Aeronautics or Aerospace applications.

Features

- 1V to 20V dropout Voltage @400mA⁽¹⁾
- 2V to 20V dropout Voltage @1A⁽¹⁾
- Max 1A output current @ 225°C
- 60dB input ripple rejection (0-100Hz)
- C_{load} from 100nF to 1000 μ F, large ESR range
- Available as die or in custom package on demand. (3-pin compatible)
- The start-up is operative over the whole temperature range
- Latch-up free

Available voltages:

- CHT-LDOP-025: 2.5V
- CHT-LDOP-033: 3.3V
- CHT-LDOP-050: 5.0V
- CHT-LDOP-055 : 5.5V
- CHT-LDOP-090 : 9.0V
- CHT-LDOP-100 : 10.0V
- CHT-LDOP-120: 12.0V
- CHT-LDOP-130: 13.0V
- CHT-LDOP-150: 15.0V

Typical application

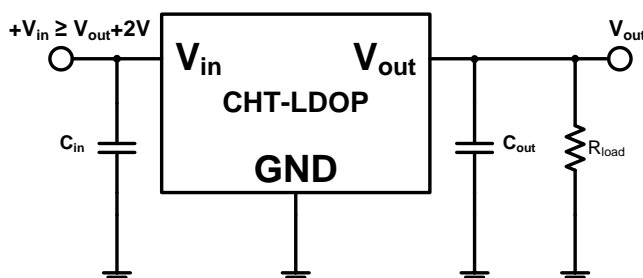

Absolute Maximum Ratings

Supply Voltage V_{in} to GND -0.3V to 40V
 Junction Temperature ⁽²⁾ T_j 300°C
 Power dissipation ⁽³⁾

Operating Conditions

Supply Voltage V_{in} to GND $V_{out}+(1V \text{ to } 20V)^{(1)}$
 Junction temperature -55°C to +225°C
 Power dissipation ⁽³⁾

ESD Rating (expected)

Human Body Model <1kV

CAUTION: Stresses above those listed in "Absolute Maximum Ratings" may cause permanent damage to the device. This is a stress only rating and operation of the device at these or any other conditions above those indicated in the operational sections of this specification is not implied. Frequent or extended exposure to absolute maximum rating conditions or above may affect device reliability.

Electrical Characteristics

Unless otherwise stated: $V_{in}=17V$, $V_{out}=15V$ (CHT-LDOP-150). **Bold underlined** values indicate values over the whole temperature range (-55°C < T_j < +225°C). For other nominal volt-ages, see notes under this table.

Parameter	Condition	Min	Typ	Max	Units
Input voltage $V_{in}^{(1)}$	-55°C < T_j < 225°C			<u>30</u>	V
Dropout voltage ($V_{in}-V_{out}$)	$I_L < 400mA$ -55°C < T_j < 225°C	<u>1</u>			V
	$I_L = 1A$ -55°C < T_j < 225°C	<u>2</u>			
Output voltage accuracy	$I_L = 10mA$ -55°C < T_j < 225°C	<u>-2</u>		<u>+2</u>	%
Output voltage temperature drift ⁽⁴⁾	$I_L = 10mA$ +25°C < T_j < 225°C	0	40	80	ppm
Output voltage line regulation (PSRR _{DC}) ⁽⁵⁾	($V_{in}-V_{out}$) = 2V to 15V $I_L = 10mA$ -55°C < T_j < 225°C	<u>-3</u>		<u>+3</u>	mV/V
Output voltage load regulation (R_{out}) ⁽⁶⁾	$I_L = 10mA$ to 1A ($V_{in}-V_{out}$) = 2V -55°C < T_j < 225°C		<u>40</u>	<u>100</u>	mV/A
Quiescent ground pin current ⁽⁷⁾	$I_L < 1A$ $T_j = -55°C$		4.1		mA
	$I_L < 1A$ $T_j = +225°C$		3.8		
Foldback current	($V_{in}-V_{out}$) = 2V to 15V -55°C < T_j < 225°C	<u>1.5</u>	<u>2</u>	<u>2.5</u>	A
Short circuit current I_{sc}	($V_{in}-V_{out}$) = 2V to 15V -55°C < T_j < 225°C		80		mA
Power supply rejection ratio PSRR ⁽⁸⁾	$f = 0$ to 100Hz $I_L = 100mA$ -55°C < T_j < 225°C		<u>60</u>		dB
Output noise e_{on}	10Hz to 10kHz $I_L = 100mA$ -55°C < T_j < 225°C		<u>tbid</u>		V _{rms}
Junction-to-ambient thermal resistance (free air) R_{thja}	TO-3 package		40		°C/W
	TO-254 package		50		
Junction-to-case thermal resistance R_{thjc}	TO-3 and TO-254 packages		5		°C/W

Notes:

- (1) The maximum input voltage V_{in} is $V_{out}+20V$ or 30V, whichever is less.
- (2) Above 225°C (T_j), a minimum load current of few mA could be required.
- (3) Max Power dissipation depends on packaging.
- (4) ppm are defined as $1e-6 \times [d(V_{out})/d(T)]/V_{out}$. For a nominal output of 15V, 40ppm corresponds to 600µV/°C.
- (5) Defining "x" as the nominal voltage, the line regulation is better than $x/5$ mV/V.
- (6) This includes the packaging parasitic resistance for TO-3 and TO-254 packages.
- (7) Defining "x" as the nominal voltage, the typical quiescent current at 2V dropout can be approximated as $2.95+x/13$ in mA @ -55°C and $2.65+x/13$ in mA at 225°C.
- (8) Preliminary data.

Input Capacitor and Output Load Recommended Specifications

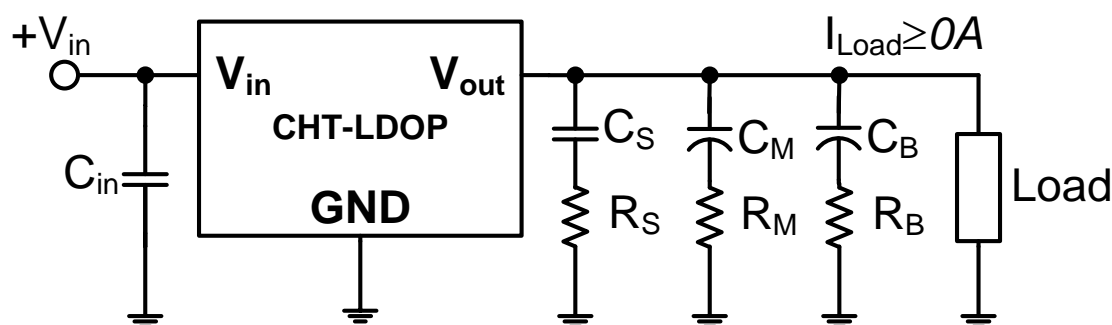

Resistances in series with capacitors represent the internal ESR of these capacitors.

Output capacitor recommendations:

Equivalent $C_{out} \geq 220\text{nF}$ with low ESR

Large capacitors:

$$C_B = 0-1000\mu\text{F}$$

$$R_B = 0.2-\infty\Omega$$

Medium capacitors:

$$C_M = 0-6\mu\text{F}$$

$$R_M = 0.1-1\Omega$$

Small capacitors:

$$C_S = 220-1000\text{nF}$$

$$R_S = 10-50\text{m}\Omega$$

Input capacitor recommendations:

Equivalent $C_{in} \geq 220\text{nF}$ with low ESR

Operating Conditions

Start-up conditions

The start-up is operative over the whole temperature range as long as all loads are connected to ground. The start-up is not guaranteed if the positive regulator output has a current path directly connected to a negative voltage. Indeed, such load condition can lead to wrong activation of the short-circuit protection, i.e. a bad start-up or a bad recovering after short-circuit. In this case, it is recommended to use our CHT-LDOS regulator family instead of CHT-LDOP regulator family.

Please refer to our application notes for more details:

- **AN-06016:** "Selecting correct CISSOID regulator depending on your application"
- **AN-06002:** "Voltage regulator short-circuit protection and associated potential startup problem".

Power dissipation considerations

When determining the maximum power dissipated by the regulator, not only the dissipation during normal operation must be considered, but also the power dissipated during any eventual short circuit or overload.

During short circuit or overload, worst case conditions are normally found for maximum V_{in} and a shorting resistance in the order of few Ohms.

Entering into short-circuit or overload conditions with high input voltages V_{in} may lead to extreme overheating, placing the part above Absolute Maximum Rating conditions.

Please refer to our application note for more detail:

- **AN-090477:** "Power Dissipation Considerations During Short Circuit Conditions"

Shorting the regulator input

If the input terminal is shorted to ground once the output capacitance has been charged, a large current corresponding to the discharge of the output capacitor will flow from the output to the input through the drain-body diode of the internal pass transistor. This large current may cause the permanent damage of the part.

Sinking current or raising the output voltage above the input voltage can cause permanent damage to the part.

Regulator floating ground

When the ground becomes disconnected, the output voltage gets unregulated, causing possible damage to other circuits connected to V_{out} . If the ground terminal is reconnected while V_{in} is applied, permanent damage may also occur to the regulator. If a regulator needs to be reconnected with the power supply on, then connect the ground terminal first.

ing possible damage to other circuits connected to V_{out} . If the ground terminal is reconnected while V_{in} is applied, permanent damage may also occur to the regulator. If a regulator needs to be reconnected with the power supply on, then connect the ground terminal first.

Typical Performance Characteristics (CHT-LDOP-150)

Note: Temperatures hereafter are ambient temperatures.

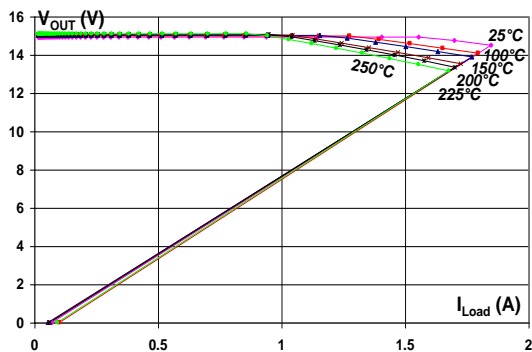

Figure 1: V_{out} vs. I_{Load} @ 2V dropout

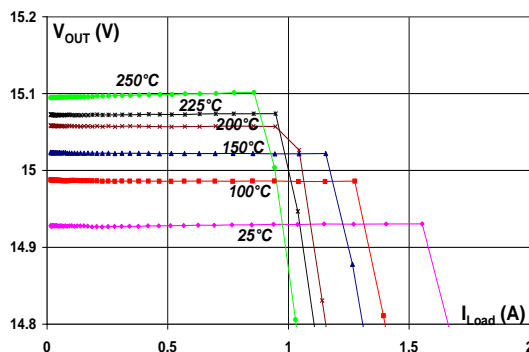

Figure 2: Zoom on figure 1

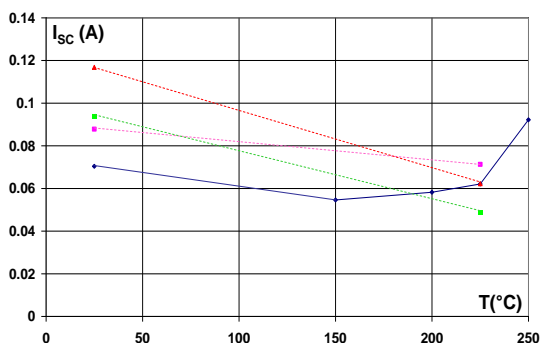

Figure 3: Typical short-circuit current vs. T° (4 samples, 2V dropout)

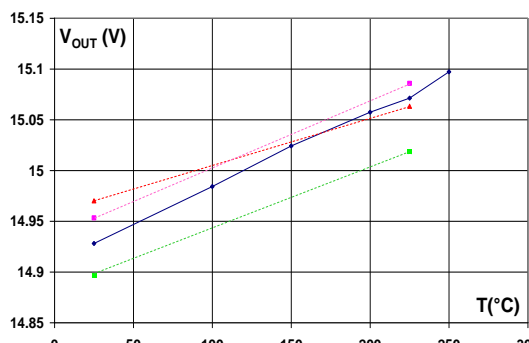

Figure 4: V_{out} vs. T° (2V dropout, 4 samples)

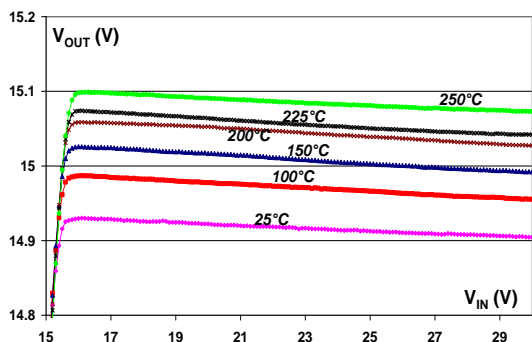

Figure 5: V_{out} vs. V_{in} over T°

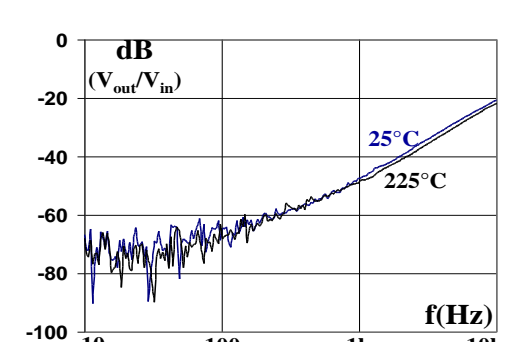

Figure 6: Input ripple rejection ($C_{out} = 1\mu F$)

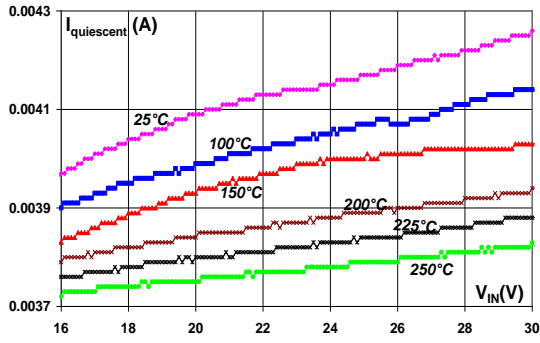

Figure 7: $I_{\text{Quiescent}}$ vs. V_{in} over T°

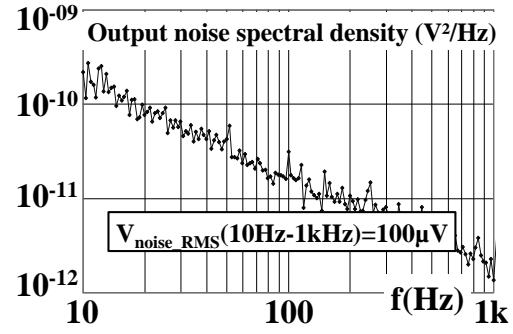

Figure 8: $S_{\text{Vout}}(\text{V}^2/\text{Hz})$ @25°C, $I_{\text{Load}}=100\text{mA}$

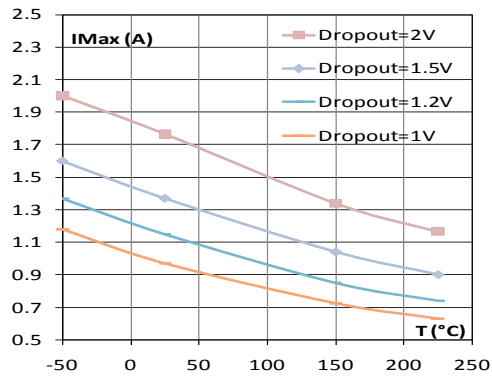
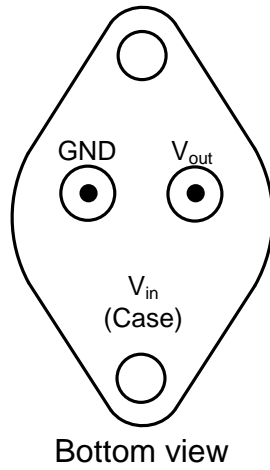

Figure 9: Typical max load current over T° vs dropout voltage

Packaging and Pinout

TO-3 Metal Can



TO-254 Header

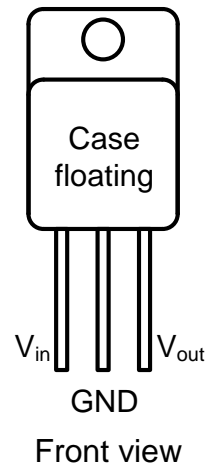

Ordering Information

Ordering Reference	Package	Output Voltage	Temperature Range	Marking
CHT-LDOP-025-TO3-T	Metal TO3	2.5V	-55°C to +225°C	CHT-LDOP-025
CHT-LDOP-025-TO254-T	Metal TO254	2.5V	-55°C to +225°C	CHT-LDOP-025
CHT-LDOP-033-TO3-T	Metal TO3	3.3V	-55°C to +225°C	CHT-LDOP-033
CHT-LDOP-033-TO254-T	Metal TO254	3.3V	-55°C to +225°C	CHT-LDOP-033
CHT-LDOP-050-TO3-T	Metal TO3	5V	-55°C to +225°C	CHT-LDOP-050
CHT-LDOP-050-TO254-T	Metal TO254	5V	-55°C to +225°C	CHT-LDOP-050
CHT-LDOP-055-TO3-T	Metal TO3	5.5V	-55°C to +225°C	CHT-LDOP-055
CHT-LDOP-055-TO254-T	Metal TO254	5.5V	-55°C to +225°C	CHT-LDOP-055
CHT-LDOP-090-TO3-T	Metal TO3	9V	-55°C to +225°C	CHT-LDOP-090
CHT-LDOP-090-TO254-T	Metal TO254	9V	-55°C to +225°C	CHT-LDOP-090
CHT-LDOP-100-TO3-T	Metal TO3	10V	-55°C to +225°C	CHT-LDOP-100
CHT-LDOP-100-TO254-T	Metal TO254	10V	-55°C to +225°C	CHT-LDOP-100
CHT-LDOP-120-TO3-T	Metal TO3	12V	-55°C to +225°C	CHT-LDOP-120
CHT-LDOP-120-TO254-T	Metal TO254	12V	-55°C to +225°C	CHT-LDOP-120
CHT-LDOP-130-TO3-T	Metal TO3	13V	-55°C to +225°C	CHT-LDOP-130
CHT-LDOP-130-TO254-T	Metal TO254	13V	-55°C to +225°C	CHT-LDOP-130
CHT-LDOP-150-TO3-T	Metal TO3	15V	-55°C to +225°C	CHT-LDOP-150
CHT-LDOP-150-TO254-T	Metal TO254	15V	-55°C to +225°C	CHT-LDOP-150

Package Dimensions

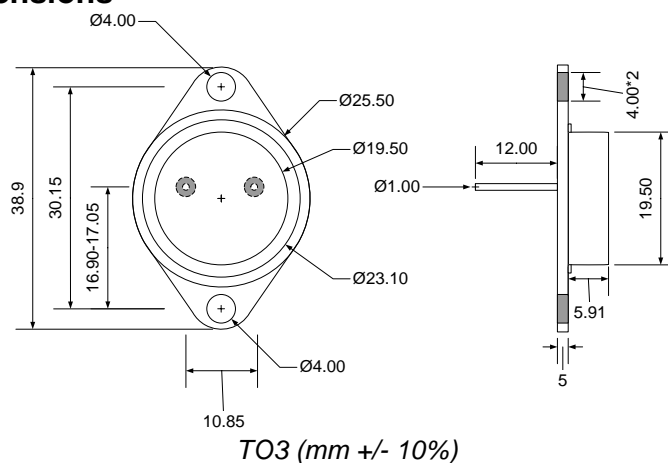

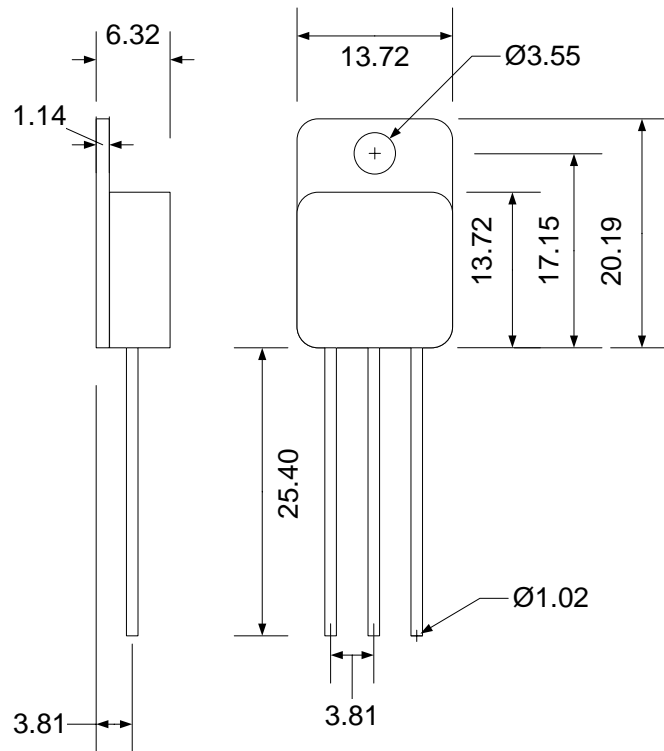

T0254 (+/- 10%)

Contact & Ordering

CISSOID S.A.

Headquarters and contact EMEA:	CISSOID S.A. – Rue Francqui, 3 – 1435 Mont Saint Guibert - Belgium T : +32 10 48 92 10 - F: +32 10 88 98 75 Email: sales@cissoid.com
Sales Representatives:	Visit our website: http://www.cissoid.com

Disclaimer

Neither CISSOID, nor any of its directors, employees or affiliates make any representations or extend any warranties of any kind, either express or implied, including but not limited to warranties of merchantability, fitness for a particular purpose, and the absence of latent or other defects, whether or not discoverable. In no event shall CISSOID, its directors, employees and affiliates be liable for direct, indirect, special, incidental or consequential damages of any kind arising out of the use of its circuits and their documentation, even if they have been advised of the possibility of such a damage. The circuits are provided "as is". CISSOID has no obligation to provide maintenance, support, updates, or modifications.