

## CDBT-54/S/C/A-G

**Reverse Voltage: 30 Volts**  
**Forward Current: 200 mA**  
**RoHS Device**

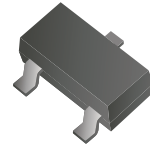

### Features

- Design for mounting on small surface.
- High speed switching application, circuit protection.
- Low forward voltage drop.

### Mechanical data

- Case: SOT-23, molded plastic.
- Terminals: solderable per MIL-STD-750, method 2026.
- Approx. weight: 0.008 grams

### Circuit diagram

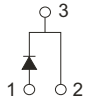

CDBT-54-G

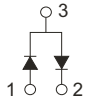

CDBT-54S-G

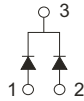

CDBT-54C-G

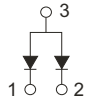

CDBT-54A-G

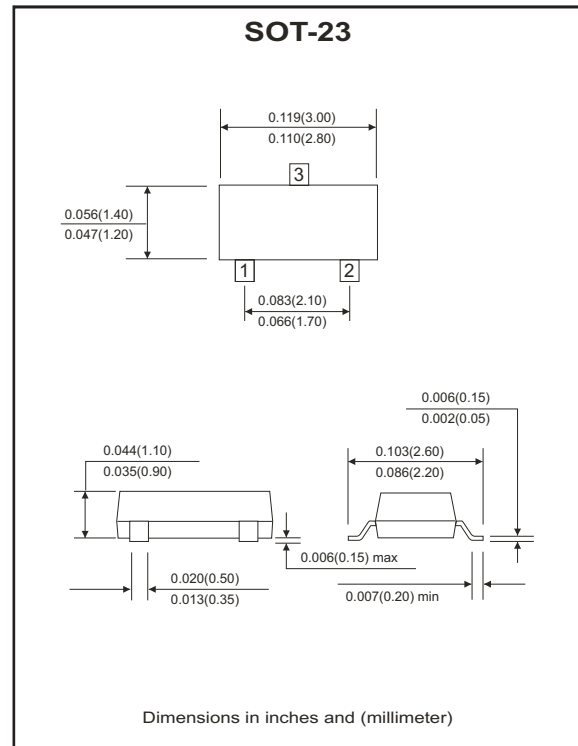

### Maximum Ratings and Electrical Characteristics

(at Ta=25°C unless otherwise noted)

Parameter	Symbol	Conditions	Value	Units
Repetitive peak reverse voltage	$V_{RRM}$		30	V
Reverse voltage	$V_R$		30	V
Forward current	$I_F$		200	mA
Peak surge forward current	$I_{FSM}$	T<1.0 sec	0.6	A
Power dissipation	$P_D$		200	mW
Maximum forward voltage	$V_F$	@ $I_F=0.1mA$ @ $I_F=1mA$ @ $I_F=10mA$ @ $I_F=30mA$ @ $I_F=100mA$	0.24 0.32 0.40 0.50 1.00	V
Maximum reverse current	$I_R$	@ $V_R=25V$	2	$\mu A$
Maximum reverse recovery time	$T_{rr}$	$I_F=I_R=10mA, R_L=100\Omega$	5	nS
Maximum diode capacitance	$C_J$	$V_R=1V, f=1.0MHz$	10	pF
Maximum junction temperature	$T_J$		125	°C
Storage temperature	$T_{STG}$		-65 to +125	°C

## RATING AND CHARACTERISTIC CURVES (CDBT-54/S/C/A-G)

Fig.1 Forward Characteristics

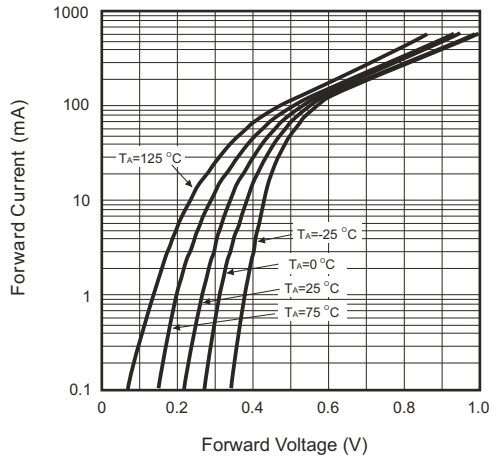

Fig.2 Reverse Characteristics

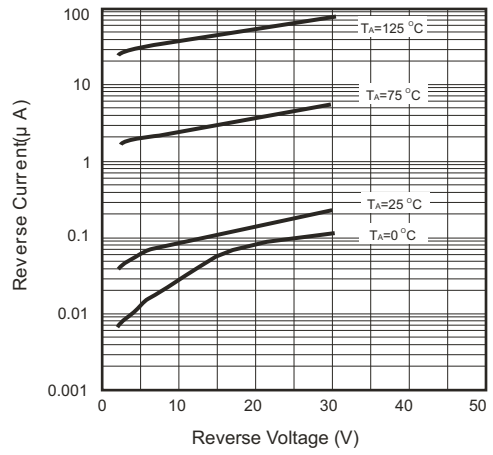

Fig.3 Capacitance Between Terminals Characteristics

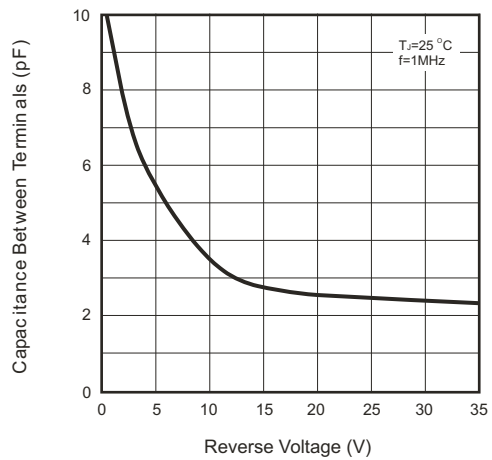

Fig.4 Power Derating Curve

