

## ACPDQC5V0HE-HF

RoHS Device  
Halogen Free



### Features

- Bi-directional ESD protection
- IEC 61000-4-5 (surge) ; IPP=8A
- IEC 61000-4-2 (ESD) ; ±30KV(contact)
- Low clamping voltage
- Low leakage current
- High surge current
- Comply with AEC-Q101

### Mechanical data

- Case: 0402C/SOD-923F Standard package, molded plastic.
- Terminals: Gold plated, solderable per MIL-STD-750, Method 2026.
- Mounting position: Any.
- Weight: 0.001 grams(approx.).

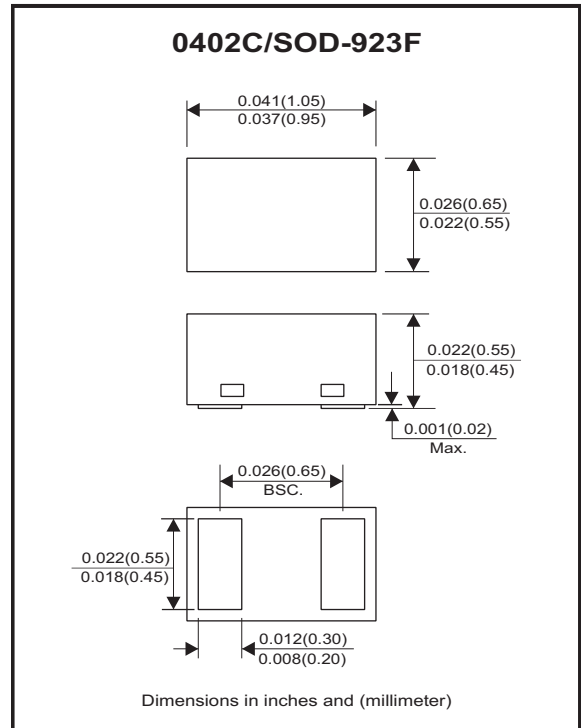

### Circuit Diagram



### Maximum Rating (at TA=25°C unless otherwise noted)

Parameter	Conditions	Symbol	Value	Unit
Peak pulse power	T <sub>P</sub> = 8/20us	P <sub>PP</sub>	128	W
Peak pulse current	T <sub>P</sub> = 8/20us	I <sub>PP</sub>	8	A
ESD capability	IEC 61000-4-2(air)	ESD	±30	kV
	IEC 61000-4-2(contact)	ESD	±30	
Operation temperature range		T <sub>J</sub>	-40~+125	°C
Storage temperature range		T <sub>STG</sub>	-55~+150	°C

### Electrical Characteristics (at TA=25°C unless otherwise noted)

Parameter	Conditions	Symbol	Min	Typ	Max	Unit
Working peak reverse voltage		V <sub>RWM</sub>			5	V
Diode breakdown voltage	I <sub>T</sub> = 1mA	V <sub>BR</sub>	5.5	7.0		V
Reverse current	V <sub>RWM</sub> = 5V	I <sub>R</sub>		0.1	1.0	uA
Clamping voltage	I <sub>PP</sub> = 1A, T <sub>P</sub> = 8/20us	V <sub>C</sub>			11	V
	I <sub>PP</sub> = 8A, T <sub>P</sub> = 8/20us	V <sub>C</sub>			16	V
Junction capacitance	V <sub>R</sub> = 0V, f = 1MHz	C <sub>J</sub>		15	20	pF

## RATING AND CHARACTERISTIC CURVES (ACPDQC5V0HE-HF)

Fig.1- 8/20us Peak Pulse Current Wave Form Acc. IEC61000-4-5

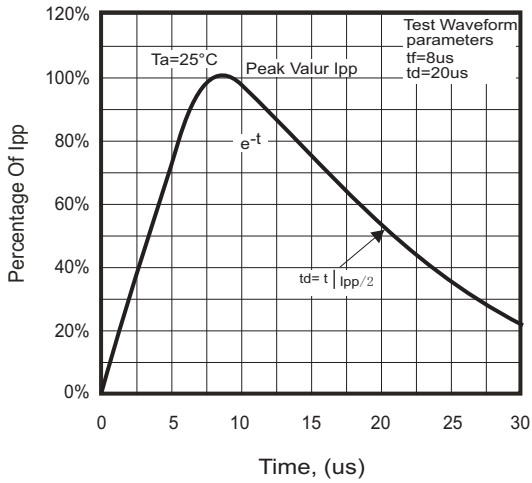

Fig.2 - Typical Capacitance Between Terminals Characteristics

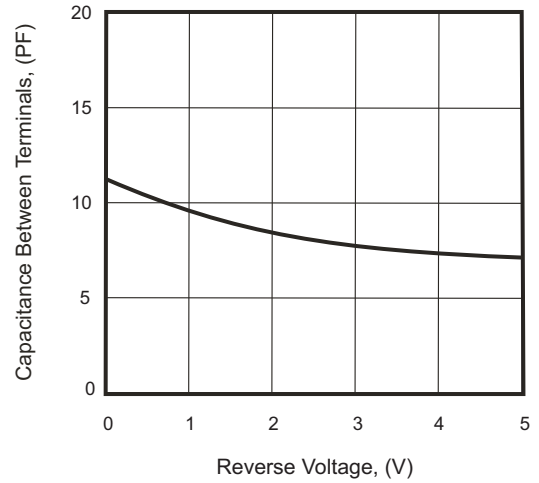

Fig.3 - Clamping Voltage Vs. Peak Pulse Current

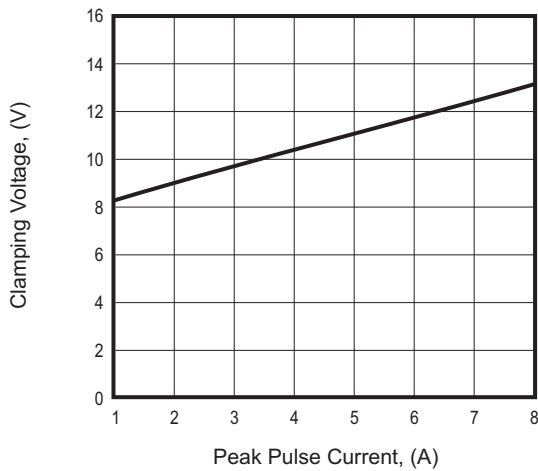
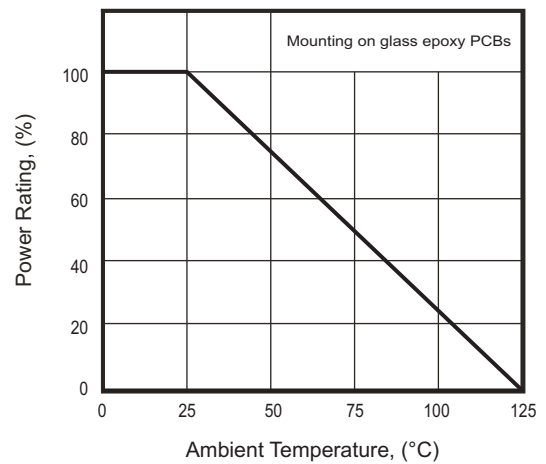
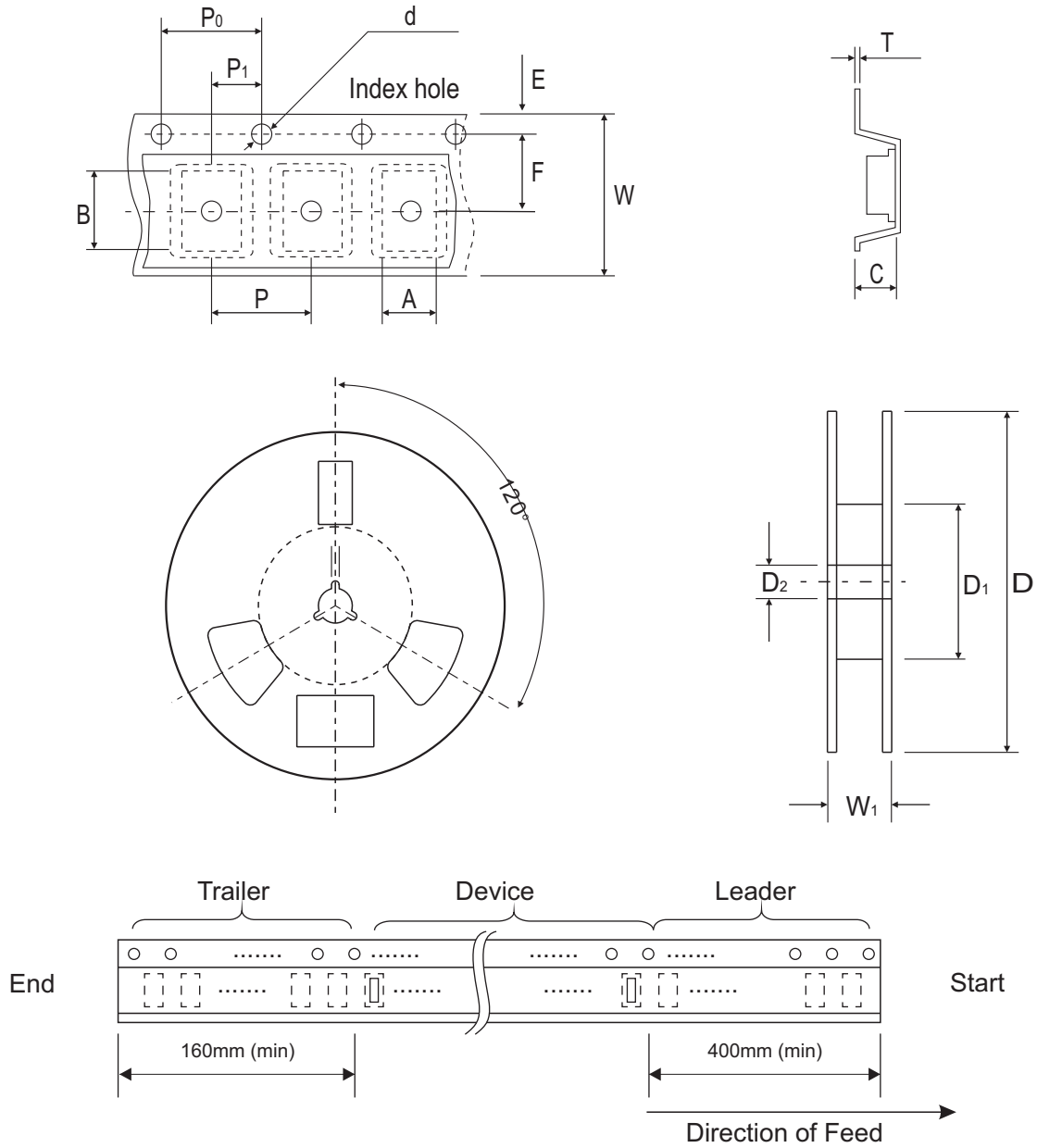

Fig. 4 - Power Rating Derating Curve



## Reel Taping Specification



0402C (SOD-923F)	SYMBOL	A	B	C	d	D	D <sub>1</sub>	D <sub>2</sub>
	(mm)	0.75 ± 0.05	1.17 ± 0.05	0.65 ± 0.05	1.50 + 0.10 - 0	178.00 ± 1.00	60.00 ± 0.50	13.50 ± 0.20
	(inch)	0.030 ± 0.002	0.046 ± 0.002	0.026 ± 0.002	0.059 + 0.004 - 0	7.008 ± 0.039	2.362 ± 0.020	0.531 ± 0.008

0402C (SOD-923F)	SYMBOL	E	F	P	P <sub>0</sub>	P <sub>1</sub>	T	W	W <sub>1</sub>
	(mm)	1.75 ± 0.10	3.50 ± 0.10	4.00 ± 0.10	4.00 ± 0.10	2.00 ± 0.10	0.20 + 0.02 - 0.05	8.00 ± 0.20	12.00 + 0.50 - 0
	(inch)	0.069 ± 0.004	0.138 ± 0.004	0.157 ± 0.004	0.157 ± 0.004	0.079 ± 0.004	0.008 + 0.001 - 0.002	0.315 ± 0.008	0.472 + 0.020 - 0

## Marking Code

Part Number	Marking Code
ACPDQC5V0HE-HF	E5



## Suggested PAD Layout

SIZE	0402C/SOD-923F	
	(mm)	(inch)
A	0.70	0.028
B	0.40	0.016
C	0.60	0.024
D	1.10	0.043
E	0.30	0.012

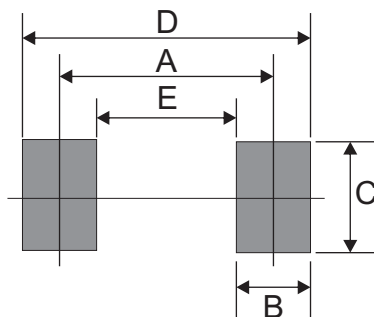

## Standard Packaging

Case Type	REEL PACK	
	REEL ( pcs )	Reel Size (inch)
0402C/SOD-923F	5,000	7