

MMST3904-G (NPN)

RoHS Device

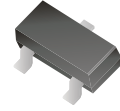

Features

- Epitaxial planar die construction
- Ideal for medium power amplification and switching.

Mechanical data

- Case: SOT-323 , Molded plastic.
- Terminals: Solderable per MIL-STD-750, method 2026.
- Mounting position: Any.
- Weight: 0.0055 gram (approx.).

Circuit diagram

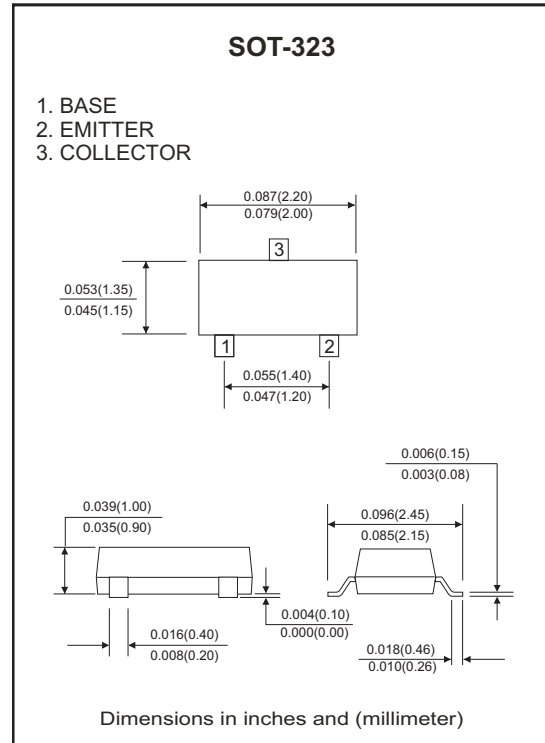
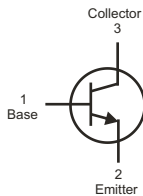

Maximum Ratings (at TA=25°C unless otherwise noted)

Parameter	Symbol	Value	Unit
Collector-base voltage	V _{CB0}	60	V
Collector-emitter voltage	V _{CEO}	40	V
Emitter-base voltage	V _{EBO}	5	V
Collector current	I _c	200	mA
Collector power dissipation	P _c	200	mW
Thermal resistance from junction to ambient	R _{θJA}	625	°C/W
Junction temperature range	T _J	150	°C
Storage temperature range	T _{STG}	-55 ~ +150	°C

Electrical Characteristics (at TA=25°C unless otherwise noted)

Parameter	Conditions	Symbol	Min	Max	Unit
Collector-Base breakdown voltage	$I_c = 10\mu A, I_E = 0$	$V_{(BR)CBO}^*$	60		V
Collector-Emitter breakdown voltage	$I_c = 1mA, I_B = 0$	$V_{(BR)CEO}^*$	40		V
Emitter-Base breakdown voltage	$I_E = 10\mu A, I_c = 0$	$V_{(BR)EBO}^*$	5		V
Collector cut-off current	$V_{CB} = 60V, I_E = 0$	I_{CBO}^*		60	nA
Collector cut-off current	$V_{CE} = 40V, I_B = 0$	I_{CEO}^*		500	nA
Collector cut-off current	$V_{EB} = 30V, V_{BE(off)} = 3V$	I_{CEX}		50	nA
DC current gain	$V_{CE} = 1V, I_c = 100\mu A$	h_{FE}^*	40		
	$V_{CE} = 1V, I_c = 1mA$		70		
	$V_{CE} = 1V, I_c = 10mA$		100	300	
	$V_{CE} = 1V, I_c = 50mA$		60		
Collector-Emitter saturation voltage	$I_c = 10mA, I_B = 1mA$	$V_{CE(sat)}^*$		0.25	V
	$I_c = 50mA, I_B = 5mA$			0.3	V
Base-Emitter saturation voltage	$I_c = 10mA, I_B = 1mA$	$V_{BE(sat)}^*$		0.85	V
	$I_c = 50mA, I_B = 5mA$			0.95	V
Transition frequency	$V_{CE} = 20V, I_c = 10mA, f = 100MHz$	f_T	300		Mhz
Output capacitance	$V_{CB} = 5V, I_E = 0, f = 1MHz$	C_{ob}		4	pF
Input capacitance	$V_{EB} = 0.5V, I_c = 0, f = 1MHz$	C_{ib}		8	pF
Delay time	$V_{CC} = 3V, V_{BE(off)} = 0.5V, I_c = 10mA, I_{B1} = 1mA$	t_d		35	nS
Rise time		t_r		35	nS
Storage time	$V_{CC} = 3V, I_c = 10mA, I_{B1} = I_{B2} = 1mA$	t_s		225	nS
Fall time		t_f		75	nS

*Pulse test: pulse width $\leq 300\mu s$, duty cycle $\leq 2.0\%$

RATING AND CHARACTERISTIC CURVES (MMST3904-G)

Fig.1 - Static Characteristic

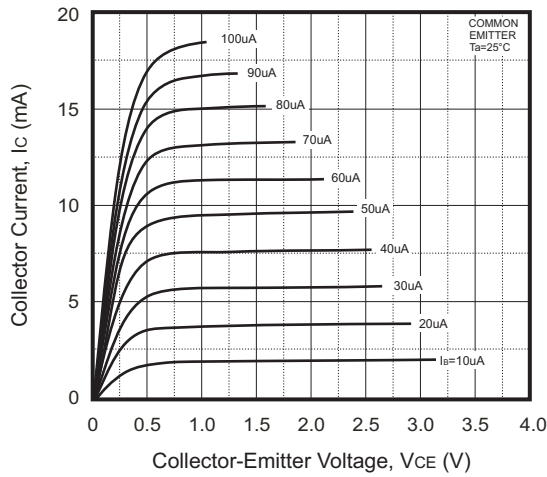

Fig.2 - $h_{FE} - I_c$

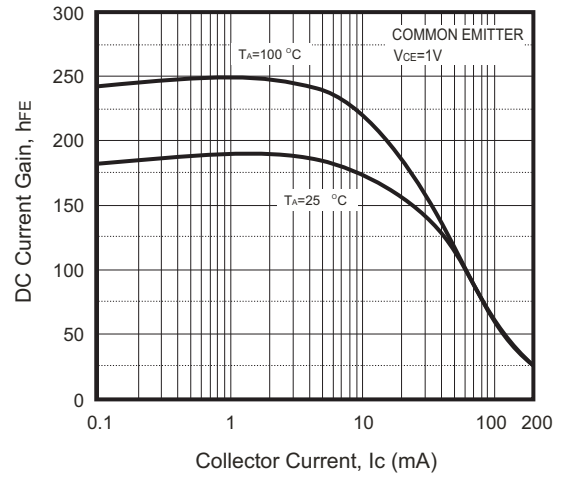

Fig.3 - $V_{BEsat} - I_c$

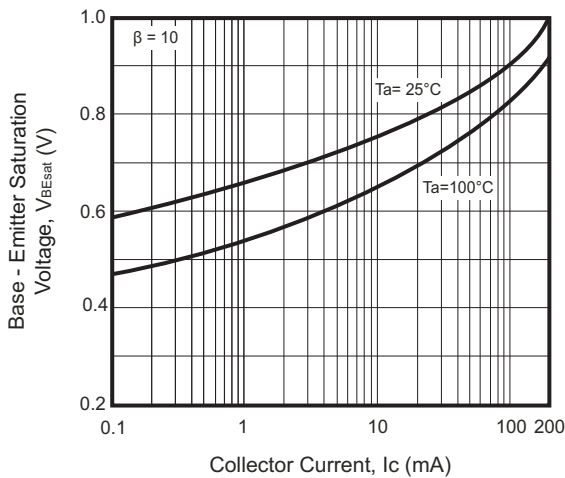

Fig.4 - $V_{CEsat} - I_c$

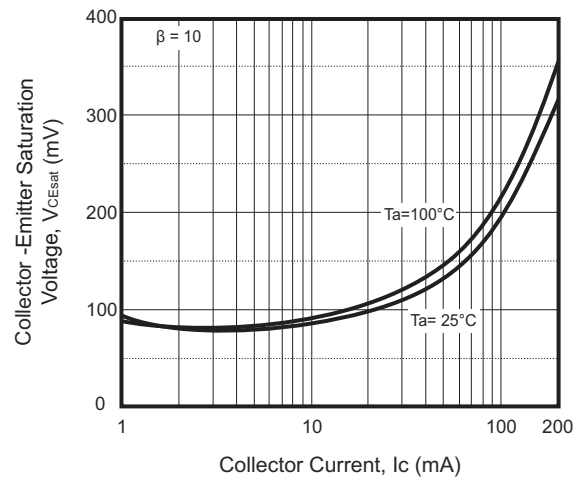

Fig.5 - $I_c - V_{BE}$

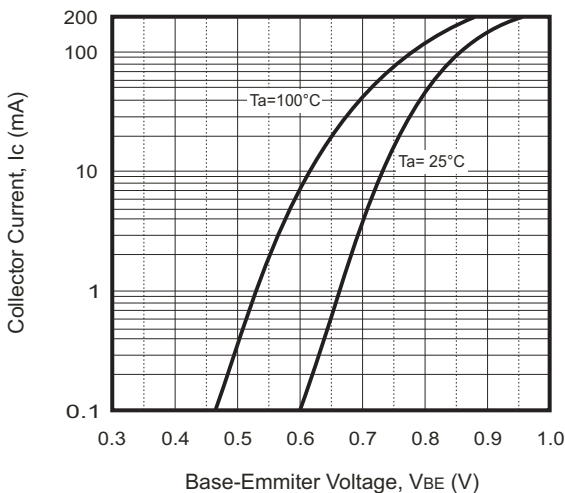
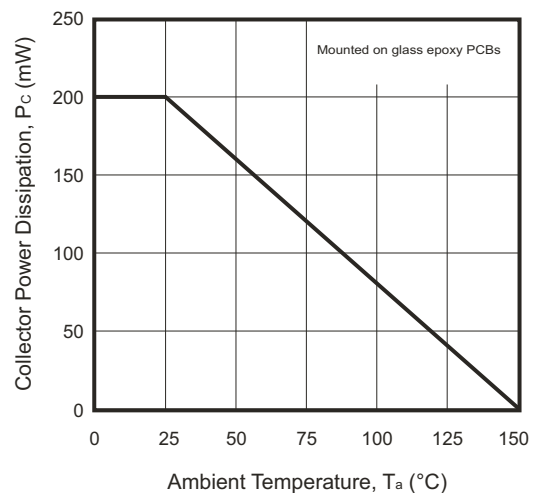
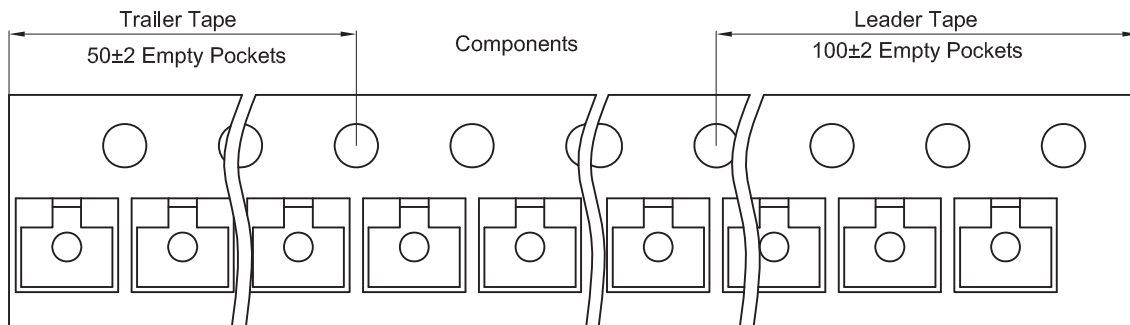
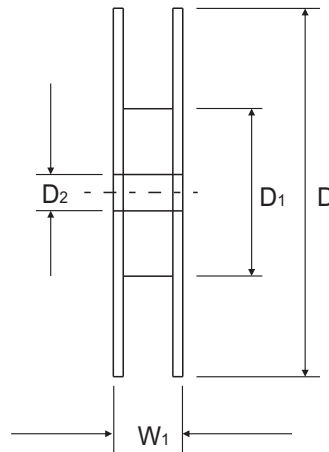
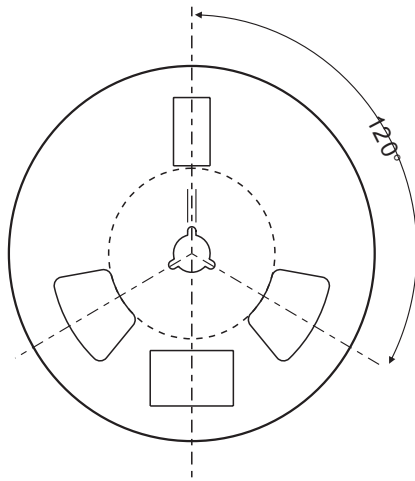
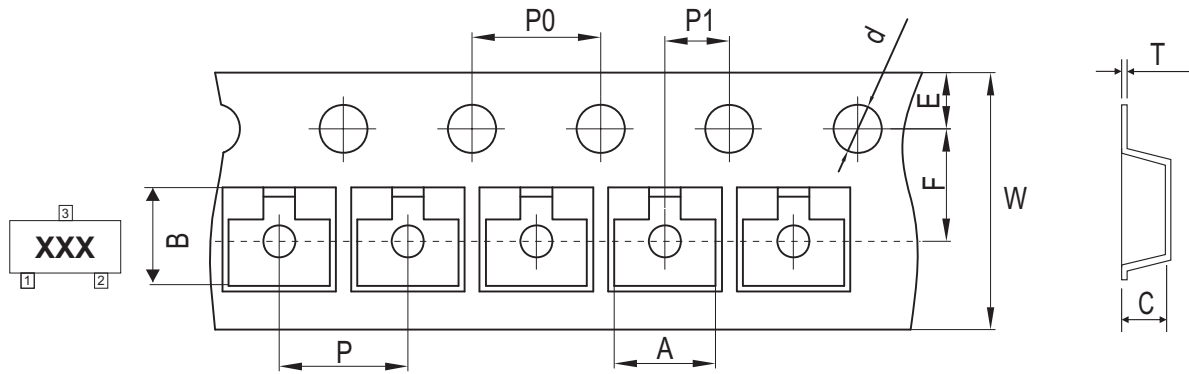

Fig.6 - $P_c - T_a$



Reel Taping Specification



SOT-323	SYMBOL	A	B	C	d	D	D1	D2
	(mm)	2.25 ± 0.05	2.55 ± 0.05	1.19 ± 0.05	1.55 ± 0.10	178.00 ± 2.00	54.40 ± 1.00	13.00 ± 1.00
	(inch)	0.089 ± 0.002	0.100 ± 0.002	0.047 ± 0.002	0.061 ± 0.004	7.008 ± 0.079	2.142 ± 0.039	0.512 ± 0.039

SOT-323	SYMBOL	E	F	P	P0	P1	W	W1
	(mm)	1.75 ± 0.10	3.50 ± 0.10	4.00 ± 0.10	4.00 ± 0.10	2.00 ± 0.10	8.00 + 0.30 / - 0.10	12.30 ± 1.00
	(inch)	0.069 ± 0.004	0.138 ± 0.004	0.157 ± 0.004	0.157 ± 0.004	0.079 ± 0.004	0.315 + 0.012 / - 0.004	0.484 ± 0.039

Marking Code

Part Number	Marking Code
MMST3904-G	K2N

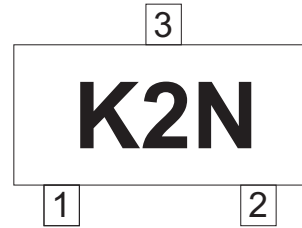

Suggested PAD Layout

SIZE	SOT-323	
	(mm)	(inch)
A	0.80	0.031
B	0.50	0.020
C	1.30	0.051
D	2.20	0.087

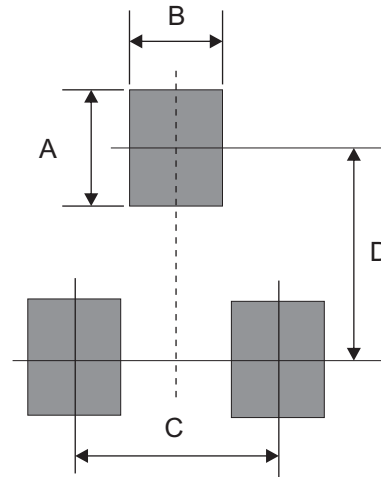

Standard Packaging

Case Type	REEL PACK	
	REEL (pcs)	Reel Size (inch)
SOT-323	3,000	7