

MMST3906-G (PNP) RoHS Device

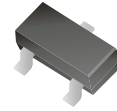

Features

- Epitaxial planar die construction.
- Ultra-small surface mount package.

Mechanical data

- Case: SOT-323 , Molded plastic.
- Terminals: Solderable per MIL-STD-750, method 2026.
- Mounting position: Any.
- Weight: 0.0055 grams(approx.).

Circuit Diagram

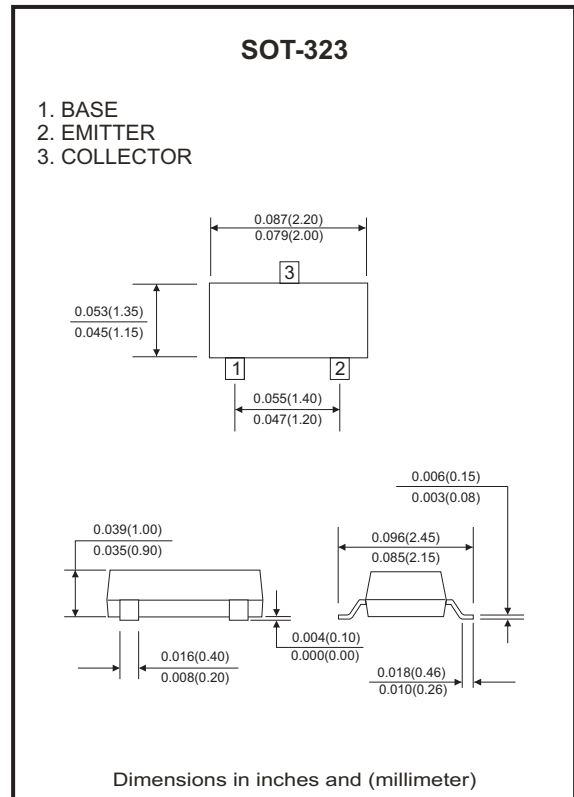
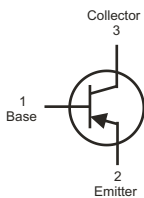

Maximum Ratings (at TA=25°C unless otherwise noted)

Parameter	Symbol	Value	Unit
Collector-base voltage	V _{CB0}	-40	V
Collector-emitter voltage	V _{CEO}	-40	V
Emitter-base voltage	V _{EBO}	-5	V
Collector current	I _c	-200	mA
Collector power dissipation	P _c	200	mW
Thermal resistance from junction to ambient	R _{θJA}	625	°C/W
Junction temperature	T _J	150	°C
Storage temperature range	T _{STG}	-55 ~ +150	°C

Electrical Characteristics (at $T_A=25^\circ\text{C}$ unless otherwise noted)

Parameter	Conditions	Symbol	Min.	Typ.	Max.	Unit
Collector-base breakdown voltage	$I_C=-10\mu\text{A}$, $I_E=0$	$V_{(BR)CBO}^*$	-40			V
Collector-emitter breakdown voltage	$I_C=-1\text{mA}$, $I_B=0$	$V_{(BR)CEO}^*$	-40			V
Emitter-base breakdown voltage	$I_E=-10\mu\text{A}$, $I_C=0$	$V_{(BR)EBO}^*$	-5			V
Base cut-off current	$V_{CE}=-30\text{V}$, $V_{EB(Off)}=-3\text{V}$	I_{BL}^*			-50	nA
Collector cut-off current	$V_{CE}=-30\text{V}$, $V_{EB(Off)}=-3\text{V}$	I_{CEX}^*			-50	nA
DC current gain	$V_{CE}=-1\text{V}$, $I_C=-100\mu\text{A}$	h_{FE}^*	60			
	$V_{CE}=-1\text{V}$, $I_C=-1\text{mA}$		80			
	$V_{CE}=-1\text{V}$, $I_C=-10\text{mA}$		100		300	
Collector-emitter saturation voltage	$I_C=-10\text{mA}$, $I_B=-1\text{mA}$	$V_{CE(sat)}^*$			-0.2	V
	$I_C=-50\text{mA}$, $I_B=-5\text{mA}$				-0.3	V
Base-emitter saturation voltage	$I_C=-10\text{mA}$, $I_B=-1\text{mA}$	$V_{BE(sat)}^*$	-0.65		-0.85	V
	$I_C=-50\text{mA}$, $I_B=-5\text{mA}$				-0.95	V
Transition frequency	$V_{CE}=-20\text{V}$, $I_C=-10\text{mA}$, $f=100\text{MHz}$	f_r	250			MHz
Output capacitance	$V_{CB}=-5\text{V}$, $I_E=0$, $f=1\text{MHz}$	C_{ob}			4.5	pF
Input capacitance	$V_{EB}=-0.5\text{V}$, $I_C=0$, $f=1\text{MHz}$	C_{ib}			10	pF
Delay time	$V_{CC}=-3\text{V}$, $V_{BE}=-0.5\text{V}$ $I_C=-10\text{mA}$, $I_{B1}=-1\text{mA}$	t_d			35	nS
Rise time		t_r			35	nS
Storage time		t_s			225	nS
Fall time	$I_{B1}=I_{B2}=-1\text{mA}$	t_f			75	nS

*Pulse test: pulse width $\leq 300\mu\text{s}$, duty cycle $\leq 2.0\%$

RATING AND CHARACTERISTIC CURVES (MMST3906-G)

Fig.1 - Static Characteristic

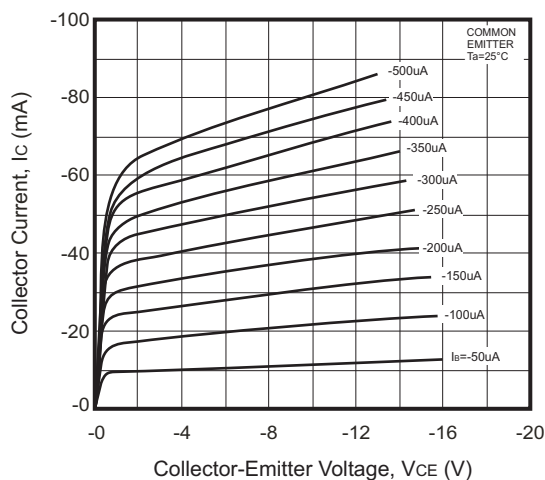
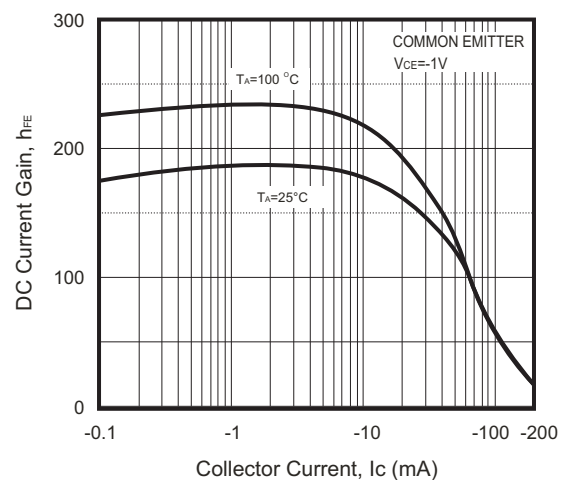

Fig.2 - $h_{FE} - I_C$



RATING AND CHARACTERISTIC CURVES (MMST3906-G)

Fig.3 - $V_{CEsat} - I_c$

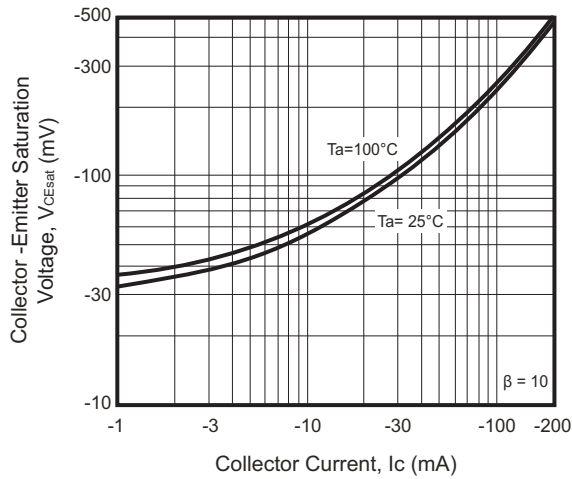

Fig.4 - $V_{BEsat} - I_c$

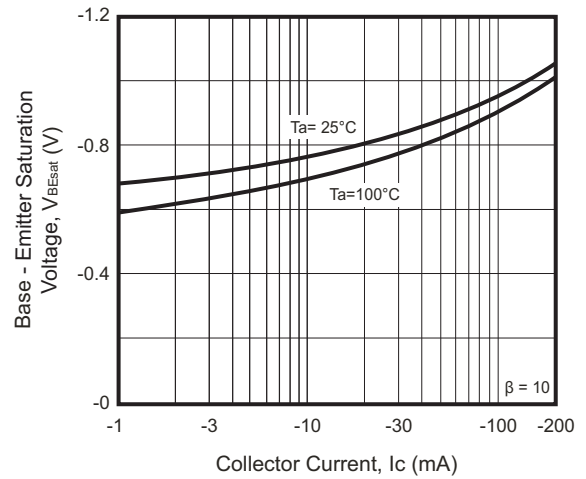

Fig.5 - $I_c - V_{BE}$

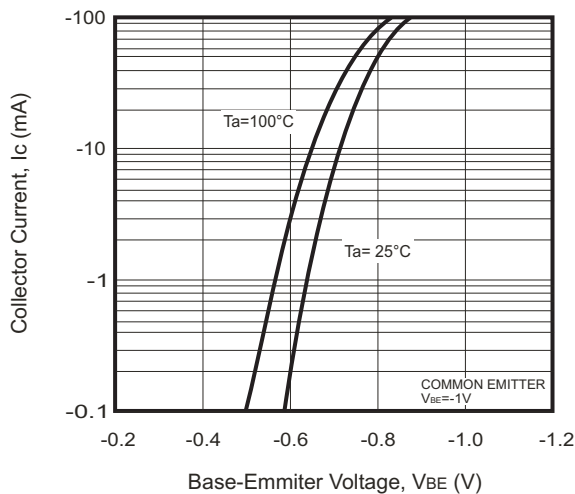

Fig.6 - $C_{ob}/C_{ib} - V_{CB}/V_{EB}$

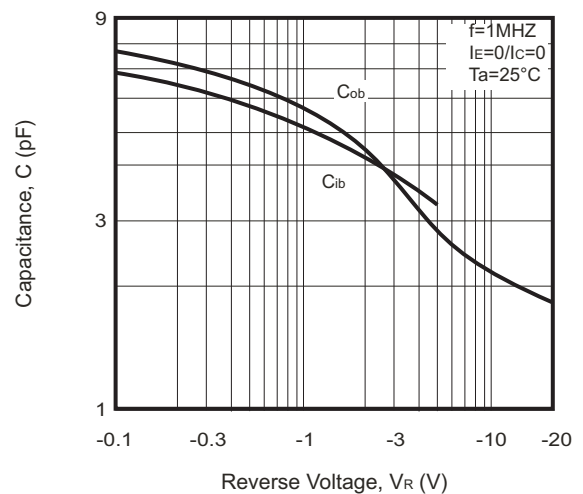

Fig.7 - $f_T - I_c$

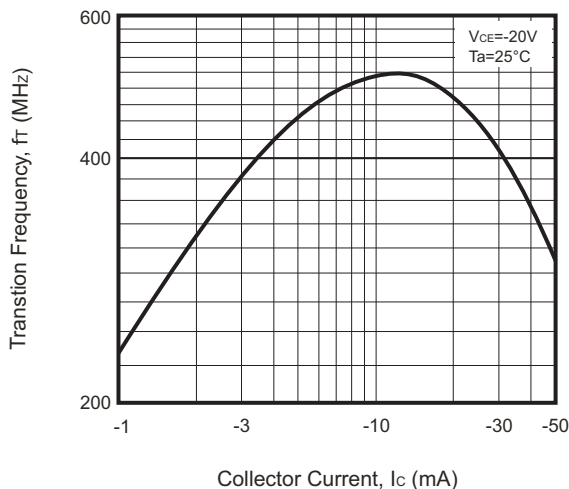
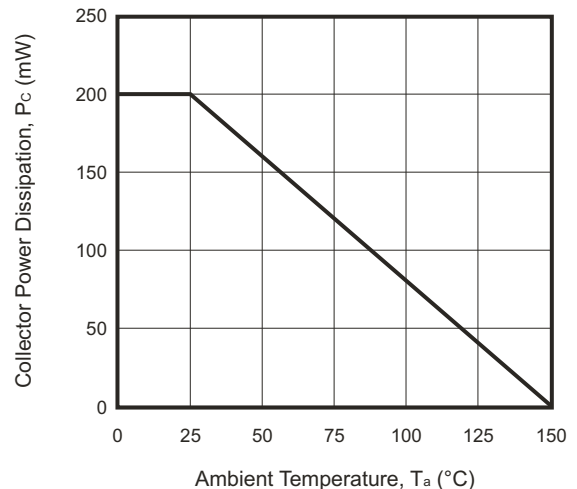
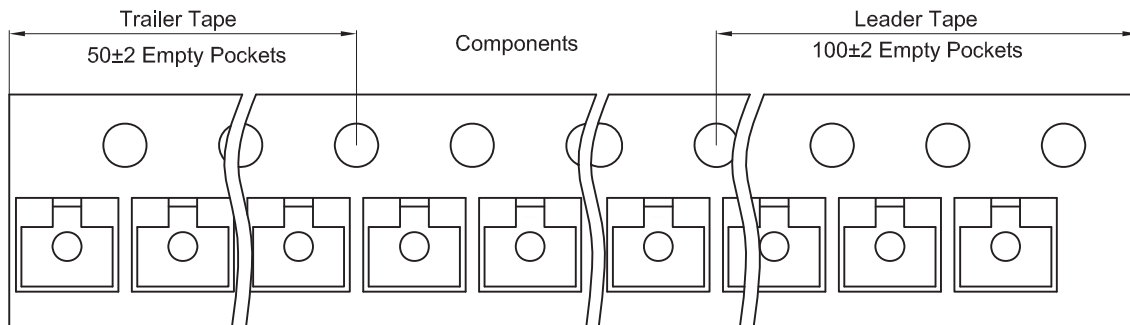
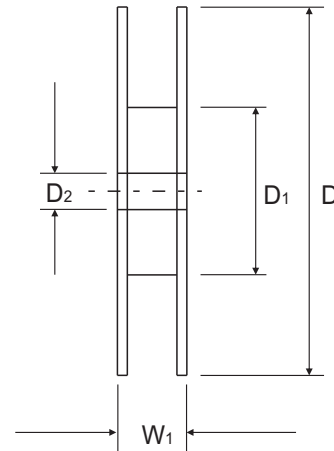
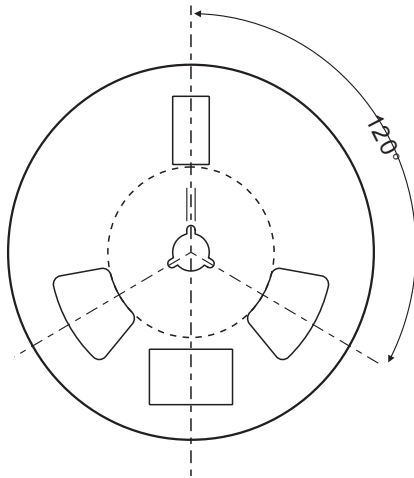
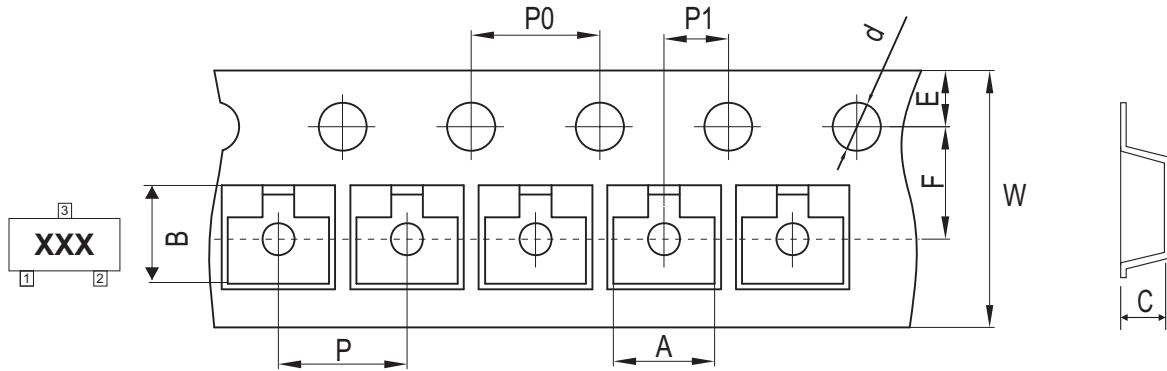

Fig.8 - $P_c - T_a$



Reel Taping Specification



SOT-323	SYMBOL	A	B	C	d	D	D1	D2
	(mm)	2.25 ± 0.05	2.55 ± 0.05	1.19 ± 0.05	1.55 ± 0.10	178.00 ± 2.00	54.40 ± 1.00	13.00 ± 1.00
	(inch)	0.089 ± 0.002	0.100 ± 0.002	0.047 ± 0.002	0.061 ± 0.004	7.008 ± 0.079	2.142 ± 0.039	0.512 ± 0.039

SOT-323	SYMBOL	E	F	P	P0	P1	W	W1
	(mm)	1.75 ± 0.10	3.50 ± 0.10	4.00 ± 0.10	4.00 ± 0.10	2.00 ± 0.10	8.00 + 0.30 / - 0.10	12.30 ± 1.00
	(inch)	0.069 ± 0.004	0.138 ± 0.004	0.157 ± 0.004	0.157 ± 0.004	0.079 ± 0.004	0.315 + 0.012 / - 0.004	0.484 ± 0.039

Marking Code

Part Number	Marking Code
MMST3906-G	K5N

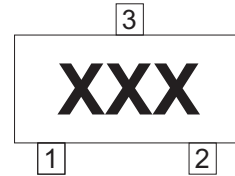

xxx = Product type marking code

Suggested PAD Layout

SIZE	SOT-323	
	(mm)	(inch)
A	0.80	0.031
B	0.50	0.020
C	1.30	0.051
D	2.20	0.087

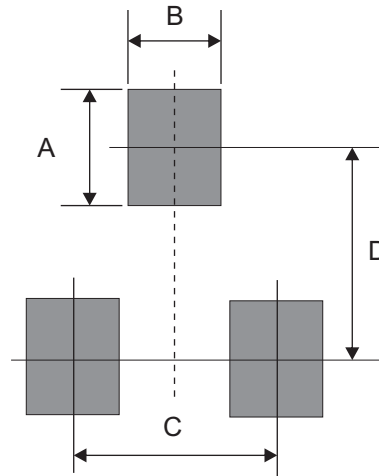

Standard Packaging

Case Type	REEL PACK	
	REEL (pcs)	Reel Size (inch)
SOT-323	3,000	7