

CEH2313-HF

P-Channel
RoHS Device
Halogen Free

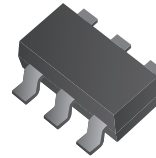

Features

- Simple drive requirement
- Low on-resistance
- Small package outline

Mechanical data

- Epoxy : UL 94V-0 rated flame retardant.
- Case : TSOP-6, molded plastic.
- Lead : Pure tin plated.

Circuit diagram

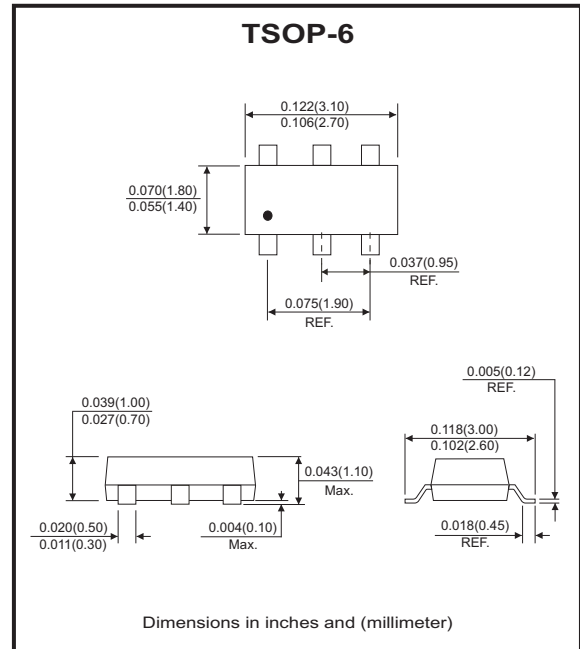
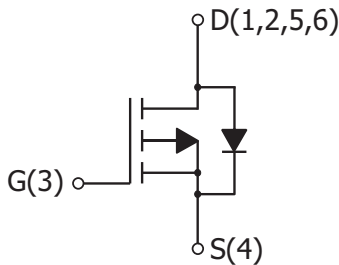

Absolute Maximum Ratings (at Ta=25°C unless otherwise noted)

Parameter	Symbol	Value	Unit
Drain-source voltage	V _{DS}	-30	V
Gate-source voltage	V _{GS}	±20	V
Drain current-continuous @ V _{GS} =-4.5V, T _A =25°C (Note 1)	I _D	-5.2	A
Drain current-continuous @ V _{GS} =-4.5V, T _A =70°C (Note 1)	I _D	-4.2	A
Pulsed Drain current (Note2,3)	I _{DM}	-30	A
Total power dissipation @ T _A =25°C	P _D	1.6	W
Linear derating factor		0.013	W/°C
Thermal resistance, Junction to ambient (Note1)	R _{θJA}	78	°C/W
Thermal resistance, Junction to case	R _{θJC}	25	
Operating junction temperature range	T _J	-55 to +150	°C
Storage temperature range	T _{STG}	-55 to +150	°C

- Notes: 1. Surface mounted on 1 in² copper pad of FR-4 board. 156°C/W when mounted on minimum copper pad.
 2. Pulse width limited by maximum junction temperature.
 3. Pulse width ≤300μs, Duty cycle ≤ 2%.

Company reserves the right to improve product design , functions and reliability without notice.

Electrical Characteristics (at Ta=25°C unless otherwise noted)

Parameter	Symbol	Conditions	Min	Typ	Max	Unit
Static						
Drain-source breakdown voltage	BV _{DSS}	V _{GS} = 0V, I _D = -250μA	-30			V
Temperature coefficient of breakdown voltage	ΔBV _{DSS} /ΔT _J	Reference to 25°C, I _D = -1mA		-0.02		V/°C
Gate-source threshold voltage	V _{GS(th)}	V _{DS} = V _{GS} , I _D = -250μA	-1	-1.6	-2.5	V
Gate-source leakage	I _{GSS}	V _{GS} = ±20V, V _{DS} = 0V			±100	nA
Zero gate voltage drain current	I _{DSS}	V _{DS} = -24V, V _{GS} = 0V			-1	μA
	I _{DSS}	V _{DS} = -24V, V _{GS} = 0V, T _J = 55°C			-10	μA
Drain-source on-state resistance	* R _{DS(on)}	I _D = -5A, V _{GS} = -10V		39	50	mΩ
		I _D = -3.7A, V _{GS} = -4.5V		61	75	
Drain-source on-state resistance	* R _{DS(on)}	I _D = -3A, V _{GS} = -4V		69	85	mΩ
		I _D = -1.5A, V _{GS} = -3V		116	150	
Forward transconductance	g _{FS}	V _{DS} = -5V, I _D = -4A		6.2		S
		V _{DS} = -10V, I _D = -1.75A		3.3		
Dynamic						
Input capacitance	C _{iss}	V _{DS} = -15V, V _{GS} = 0V, f = 1MHz		829		pF
Output capacitance	C _{oss}			85		
Reverse transfer capacitance	C _{rss}			69		
Turn-on delay time	* t _{d(on)}	V _{DS} = -15V, I _D = -1A V _{GS} = -10V, R _G = 6Ω		17		nS
Turn-on rise time	* t _r			12		
Turn-off delay time	* t _{d(off)}			24		
Turn-off fall time	* t _f			12		
Total gate charge	* Q _g	V _{DS} = -24V, I _D = -5A, V _{GS} = -5V		10		nC
Gate-source charge	* Q _{gs}			2.6		
Gate-drain charge	* Q _{gd}			4.9		
Source-Drain Diode						
Continuous souce-drain diode current	* I _S				-2	A
Pulse diode forward current	* I _{SM}				-8	
Diode forward voltage	* V _{SD}	I _S = -1.7A, V _{GS} = 0V		-0.77	-1.2	V
Reverse recovery time	* t _{rr}	I _S = -1.7A, V _{GS} = 0V		28		nS
Recovered charge	* Q _{rr}	dI _F /dt = 100A/μs		22		nC

*Pulse test: Pulse width ≤ 300μs, Duty cycle ≤ 2%

RATING AND CHARACTERISTIC CURVES (CEH2313-HF)

Fig.1 - Typical Output Characteristics

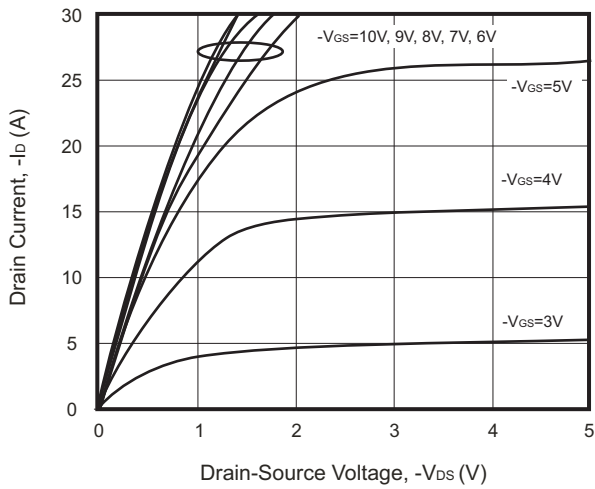

Fig.2 - Static Drain-Source On-State Resistance VS Drain Current

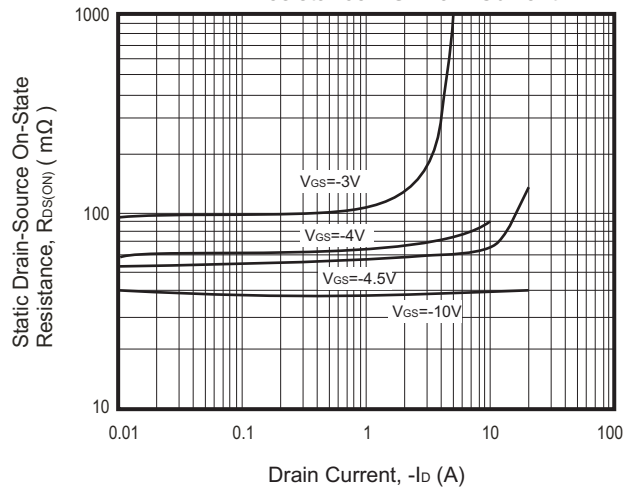

Fig.3 - Static Drain-Source On-State Resistance VS Gate-Source Voltage

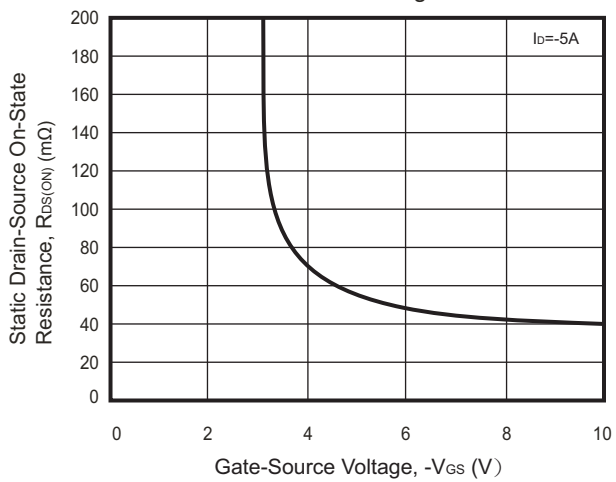

Fig.4 - Capacitance VS Drain-Source Voltage

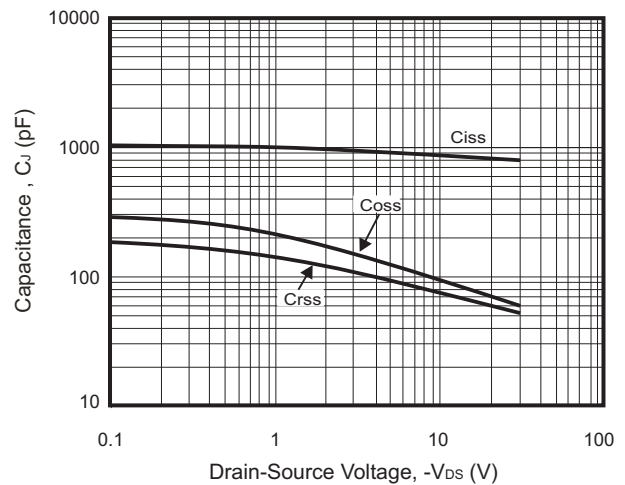

Fig.5 - Forward Transfer Admittance vs Drain Current

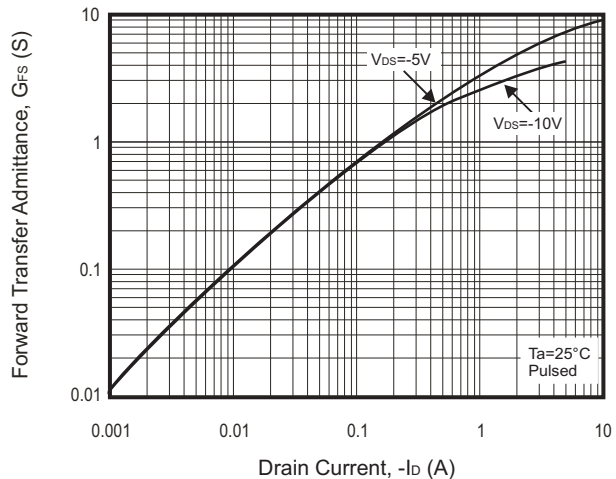
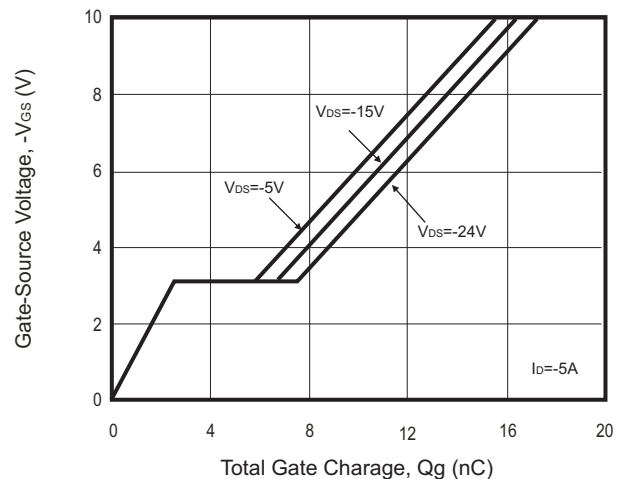
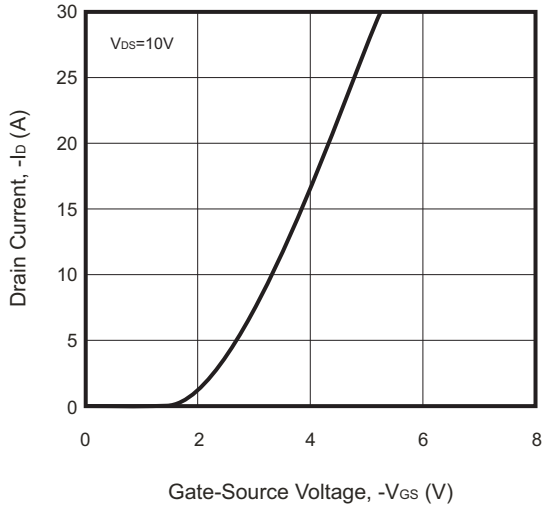

Fig.6 - Gate Charge Characteristics



RATING AND CHARACTERISTIC CURVES (CEH2313-HF)

Fig.7 - Typical Transfer Characteristics



Reel Taping Specification

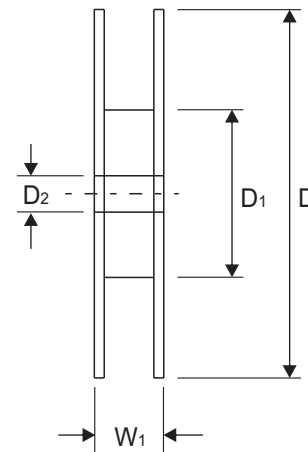
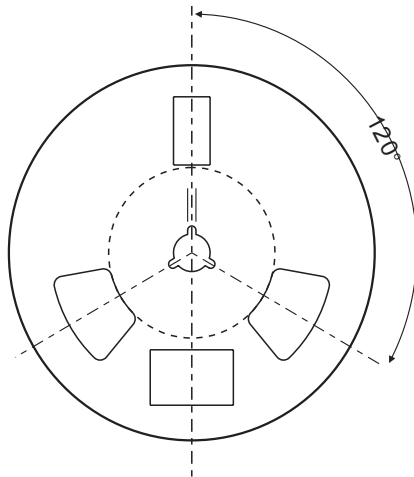
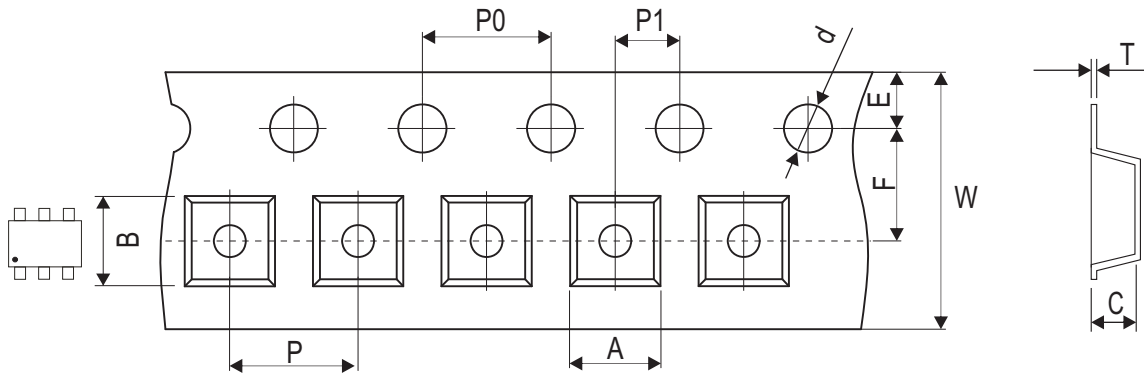

TSOP-6	SYMBOL	A	B	C	d	D	D1	D2
	(mm)	3.17 ± 0.10	3.10 ± 0.10	1.10 ± 0.10	1.50 + 0.10 - 0.00	180.00 + 0.00 - 3.00	60.00 ± 0.50	13.00 ± 0.20
	(inch)	0.125 ± 0.004	0.122 ± 0.004	0.043 ± 0.004	0.059 + 0.001 - 0.00	7.087 + 0.00 - 0.118	2.362 ± 0.020	0.512 ± 0.008

TSOP-6	SYMBOL	E	F	P	P0	P1	T	W	W1
	(mm)	1.75 ± 0.10	3.50 ± 0.10	4.00 ± 0.10	4.00 ± 0.10	2.00 ± 0.05	0.25 ± 0.03	8.00 + 0.30 - 0.10	12.30 + 1.00 - 0.30
	(inch)	0.069 ± 0.004	0.138 ± 0.004	0.157 ± 0.004	0.157 ± 0.004	0.079 ± 0.002	0.010 ± 0.001	0.315 + 0.012 - 0.004	0.484 + 0.039 - 0.012

Company reserves the right to improve product design , functions and reliability without notice.

Marking Code

Part Number	Marking Code
CEH2313-HF	658

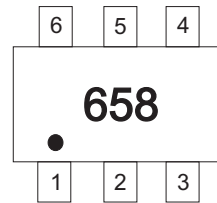

Suggested PAD Layout

SIZE	TSOP-6	
	(mm)	(inch)
A	1.00 Min	0.039 Min
B	0.70 Min	0.028 Min
C	0.95 Min	0.037Min
D	2.40 Min	0.094Min
E	3.40 Min	0.134 Min

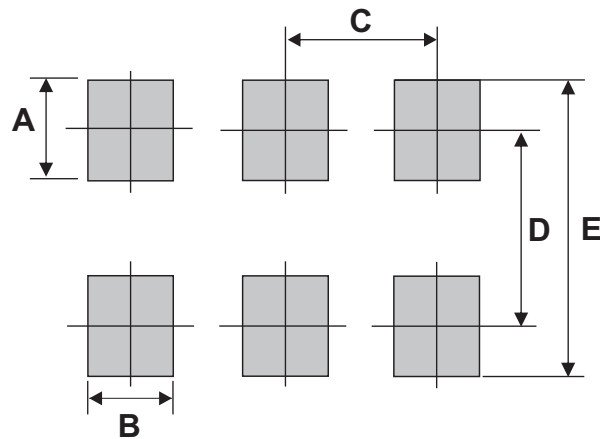

Standard Packaging

Case Type	REEL PACK	
	REEL (pcs)	Reel Size (inch)
TSOP-6	3,000	7