

ATV50D2-220J-HF

Working Voltage: 22 V

Peak Pulse Power: 5000 W

RoHS Device

Halogen Free



Features

- Uni-directional
- 5kW peak pulse power capability with a 10/1000 μ s waveform, repetitive rate (duty cycle): 0.01%
- Excellent clamping capability.
- Low incremental surge resistance.
- Glass passivated chip junction.
- Comply with AEC-Q101

Mechanical data

- Epoxy: UL94-V0 rated flame retardant
- Case: TO-263/D2PAK, molded plastic.
- Terminals: Solder plated, Solderable per MIL-STD-750, method 2026.
- Mounting Position: Any
- Weight: 1.46 grams(approx.).

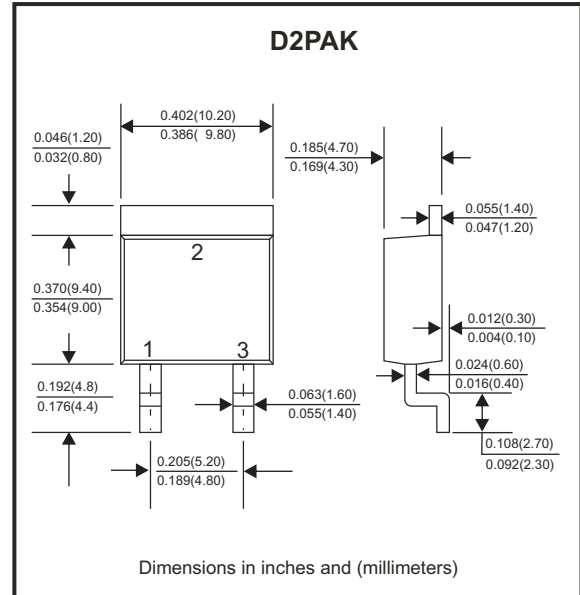

Circuit Diagram

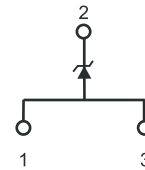

Maximum Ratings (at TA=25°C unless otherwise noted)

Parameter	Conditions	Symbol	Value	Unit
Peak power dissipation	With a 10/1000 μ s waveform, Note 1, 2 & Fig.1	P _{PPM}	5000	W
Peak pulse current	With a 10/1000 μ s waveform	I _{PPM}	140.8	A
Steady state power dissipation	at T _L =75°C, Note 2	P _{M(AV)}	6.5	W
Peak forward surge current	8.3ms single half sine-wave, Note 3	I _{FSM}	300	A
Maximum instantaneous forward voltage	at I _F = 100A	V _F	3.5	V
Operation junction temperature range		T _J	-55 to +150	°C
Storage temperature range		T _{STG}	-65 to +175	°C

Notes: 1. Non-repetitive current pulse, per Fig.3 and derated above TA=25°C per Fig.2
 2. Mounted on copper pad area per Fig.5
 3. Measured on 8.3 ms single half sine-wave or equivalent square wave, duty cycle = 4 pulses per minute maximum.

Electrical Characteristics (at TA=25°C unless otherwise noted)

Part No.	Reverse Stand-off Voltage	Breakdown voltage @ I _T		Test current	Maximum clamping voltage@I _{PP}		Maximum Reverse Leakage Current	Marking Code
	V _{RWM}	V _{BR Min.}	V _{BR Max.}	I _T	V _C	I _{PP}	I _{R@V_{RWM}}	
	V	V	V	mA	V	A	μ A	
ATV50D2-220J-HF	22	24.4	26.9	1.0	35.5	140.8	5	5KP22AY

RATING AND CHARACTERISTIC CURVES (ATV50D2-220J-HF)

Fig.1 - Peak Pulse Power Rating Curve

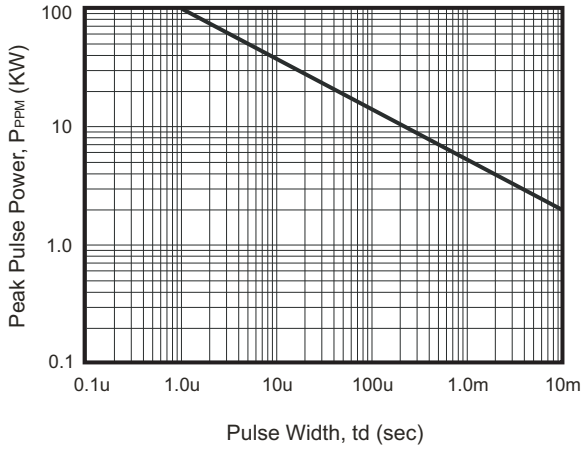

Fig.2 - Pulse Derating Curve

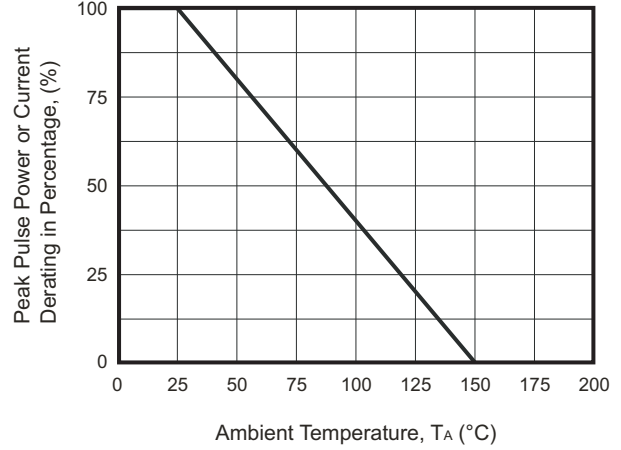

Fig.3 - Pulse Waveform

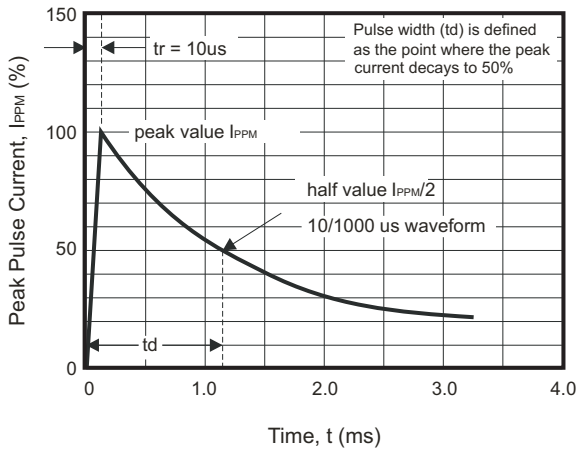

Fig.4 - Typical Junction Capacitance

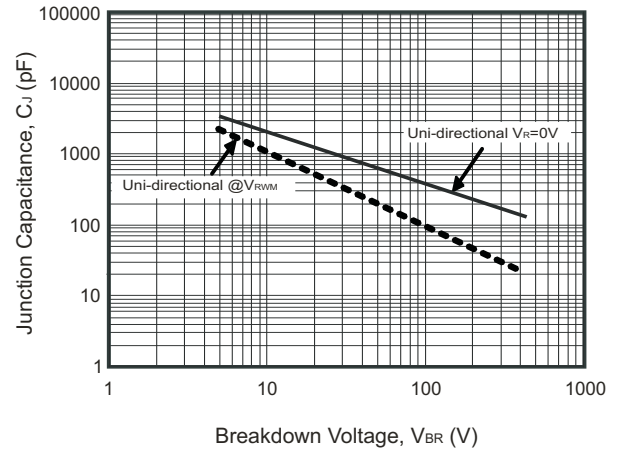

Fig.5 - Steady State Power Derating Curve

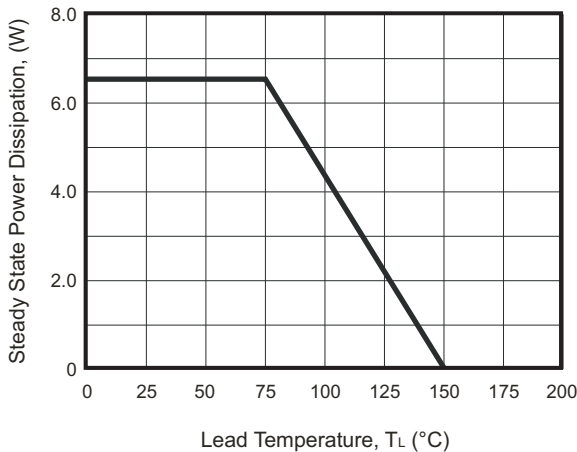
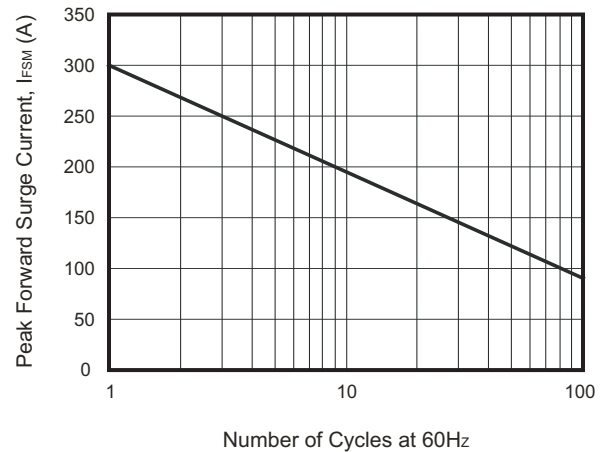
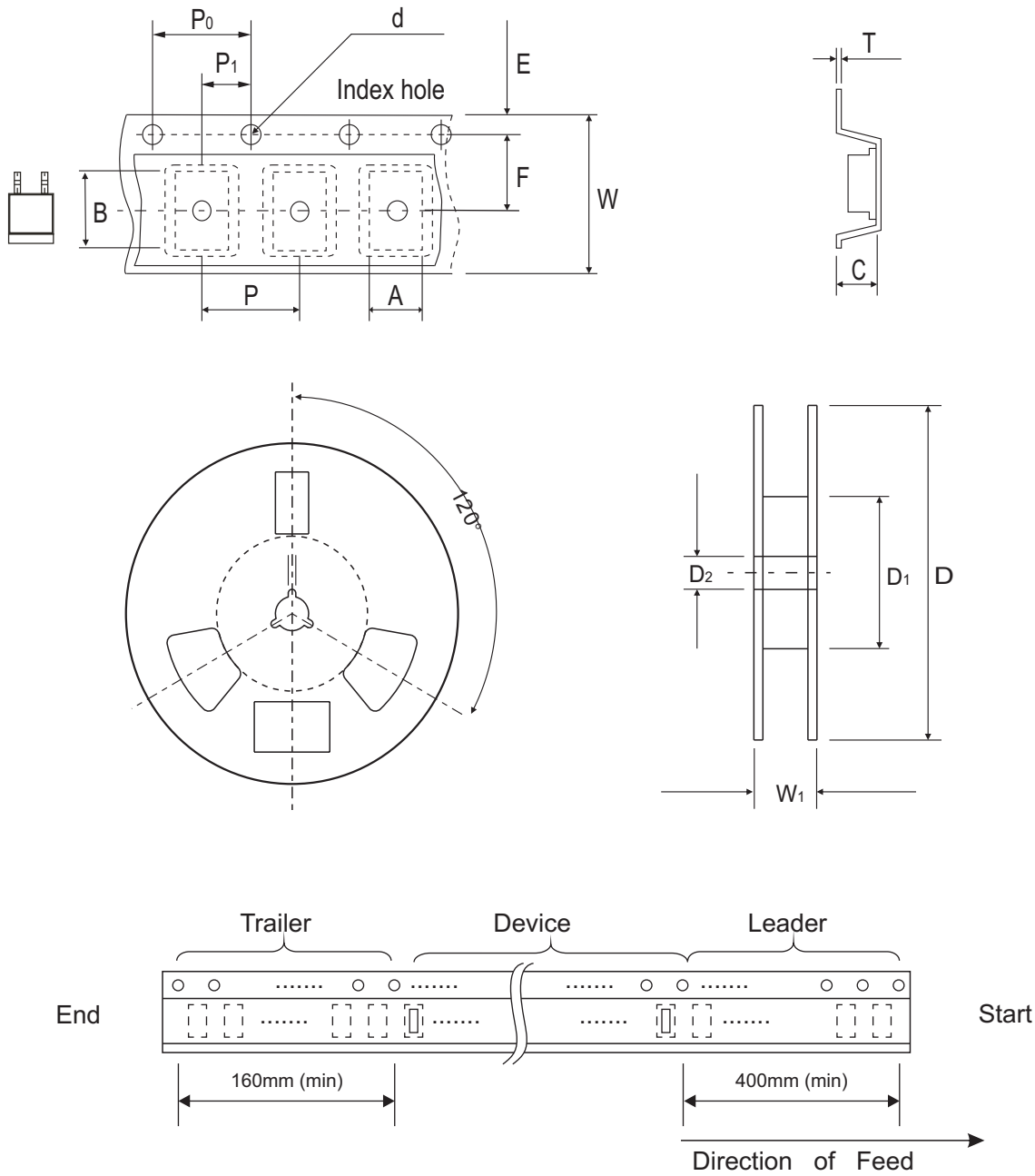

Fig.6 - Maximum Non-Repetitive Forward Surge Current



Reel Taping Specification



	SYMBOL	A	B	C	d	D	D1	D2
TO-263/D2PAK	(mm)	10.70 ± 0.10	16.30 ± 0.10	5.10 ± 0.10	1.50 ± 0.10	330.00 ± 2.00	50.00 MIN.	13.00 ± 0.50
	(inch)	0.421 ± 0.004	0.642 ± 0.004	0.201 ± 0.004	0.059 ± 0.004	12.992 ± 0.079	1.969 MIN.	0.512 ± 0.020

	SYMBOL	E	F	P	P0	P1	T	W	W1
TO-263/D2PAK	(mm)	1.75 ± 0.10	11.50 ± 0.10	16.00 ± 0.10	4.00 ± 0.10	2.00 ± 0.10	0.23 ± 0.10	24.00 ± 0.30	30.00 ± 1.0
	(inch)	0.069 ± 0.004	0.453 ± 0.004	0.630 ± 0.004	0.157 ± 0.004	0.079 ± 0.004	0.009 ± 0.004	0.945 ± 0.012	1.181 ± 0.039

Marking Code

Part Number	Marking Code
ATV50D2-220J-HF	5KP22AY

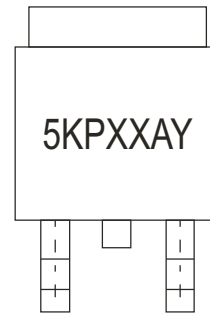

xx = Product type marking code

Suggested PAD Layout

SIZE	TO-263 / D2PAK	
	(mm)	(inch)
A	9.50	0.374
B	2.50	0.098
C	16.90	0.665
X1	10.80	0.425
X2	1.80	0.071
Y1	11.40	0.449
Y2	3.50	0.138

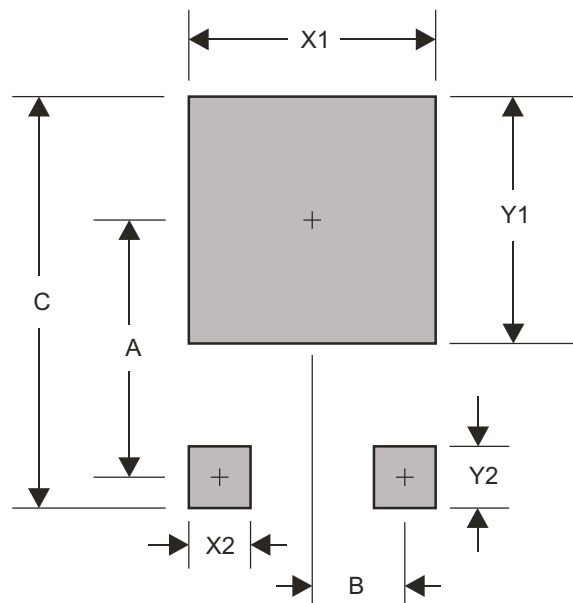

Standard Packaging

Case Type	REEL PACK	
	REEL (pcs)	Reel Size (inch)
TO-263/D2PAK	800	13