

## CFRL101 Thru CFRL107

**Reverse Voltage: 50 - 1000 Volts**  
**Forward Current: 1.0 Amp**



### Features

- Ideal for surface mount applications
- Easy pick and place
- Plastic package has Underwriters Lab. flammability classification 94V-0
- Fast recovery time: 150 - 500 nS
- Low leakage current

### Mechanical data

- Case: DO-213AB molded plastic
- Terminals: solderable per MIL-STD-750, method 2026
- Polarity: Color band denotes cathode end
- Mounting position: Any
- Approx. Weight: 0.116 gram

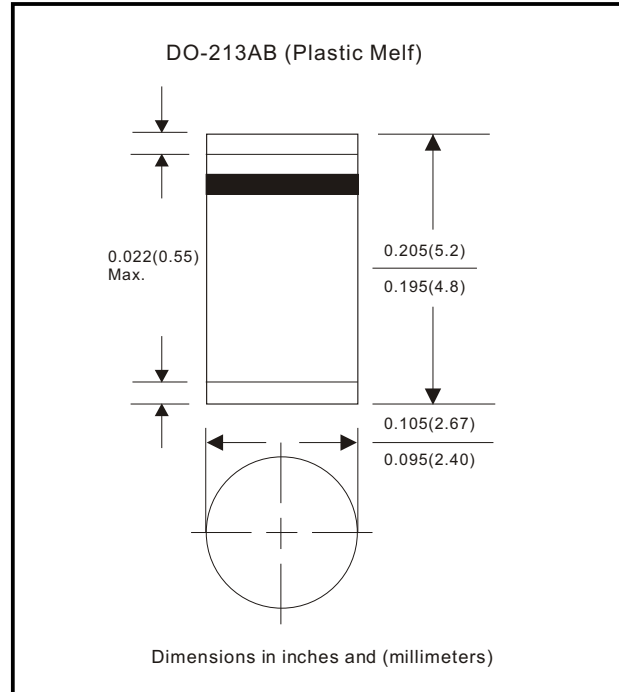

### Maximum Ratings and Electrical Characteristics

Parameter	Symbol	CFRL 101	CFRL 102	CFRL 103	CFRL 104	CFRL 105	CFRL 106	CFRL 107	Unit	
Max. Repetitive Peak Reverse Voltage	V <sub>RRM</sub>	50	100	200	400	600	800	1000	V	
Max. DC Blocking Voltage	V <sub>DC</sub>	50	100	200	400	600	800	1000	V	
Max. RMS Voltage	V <sub>RMS</sub>	35	70	140	280	420	560	700	V	
Peak Surge Forward Current 8.3ms single halfsine-wave superimposed on rate load ( JEDEC method)	I <sub>FSM</sub>	30							A	
Max. Average Forward Current	I <sub>o</sub>	1.0							A	
Max. Instantaneous Forward Current at 1.0 A	V <sub>F</sub>	1.3							V	
Reverse recovery time	T <sub>rr</sub>	100			250		500		nS	
Max. DC Reverse Current at Rated DC Blocking Voltage Ta=25°C Ta=100°C	I <sub>R</sub>	5.0				50				uA
Max. Thermal Resistance (Note 1)	R <sub>θJA</sub>	42							°C/W	
Operating Junction Temperature	T <sub>j</sub>	-55 to +150							°C	
Storage Temperature	T <sub>STG</sub>	-55 to +150							°C	

Note 1: Thermal resistance from junction to ambient.

## Rating and Characteristic Curves (CFRL101 Thru CFRL107)

Fig. 1 - Reverse Characteristics

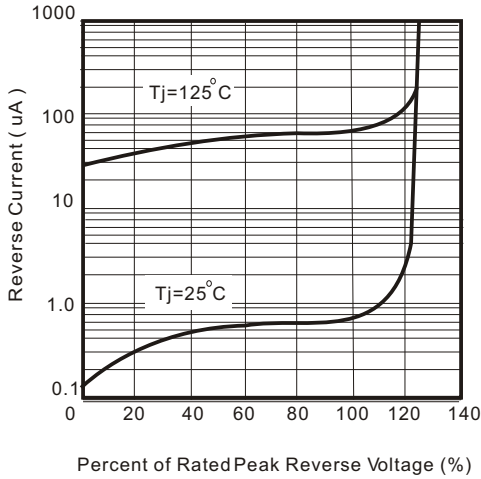

Fig.2 - Forward Characteristics

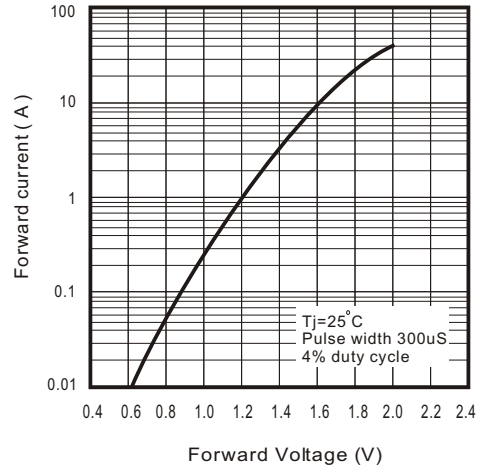

Fig. 3 - Junction Capacitance

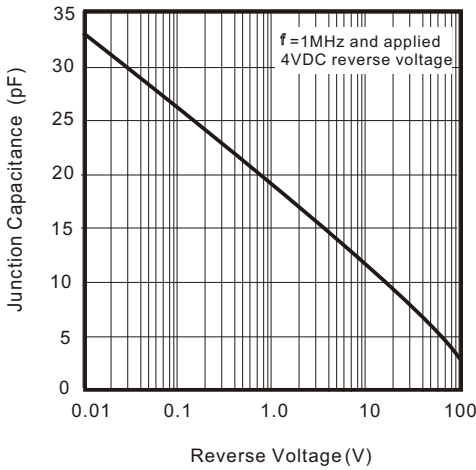

Fig. 4 - Non Repetitive Forward Surge Current

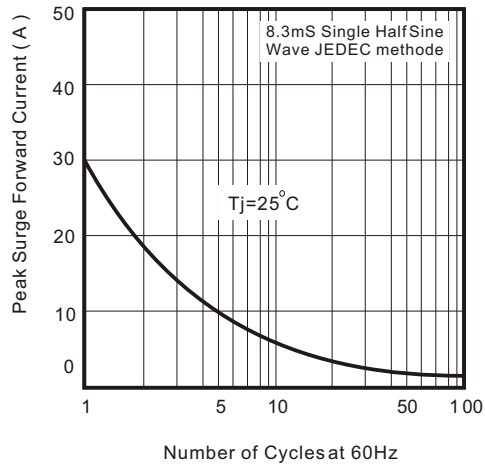
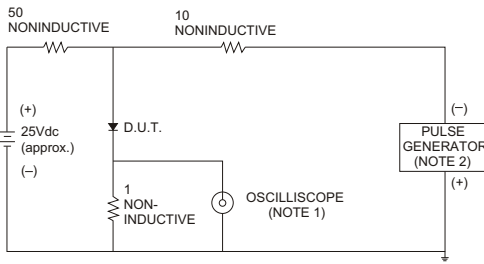

Fig. 5 - Test Circuit Diagram and Reverse Recovery Time Characteristics



NOTES: 1. Rise Time= 7ns max., Input Impedance= 1 megohm.22pF.  
2. Rise Time= 10ns max., Source Impedance= 50 ohms.

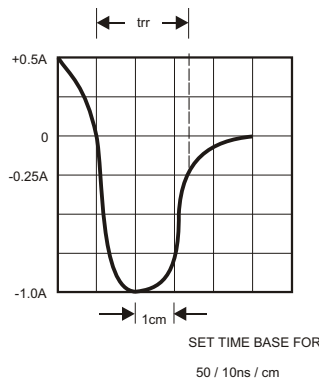

Fig. 6 - Current Derating Curve

