

SMD Switching Diode



SMD Diodes Specialist

CDSU4148-HF (RoHS Device)

High Speed



Features

- Halogen free.
- Designed for mounting on small surface.
- Extremely thin/leadless package.
- High mounting capability, strong surge withstand, high reliability.

Mechanical data

- Case: 0603 (1608) standard package, molded plastic.
- Terminals: Gold plated, solderable per MIL-STD-750, method 2026.
- Polarity: Indicated by cathode band.
- Mounting position: Any.
- Weight: 0.003 gram (approx.).

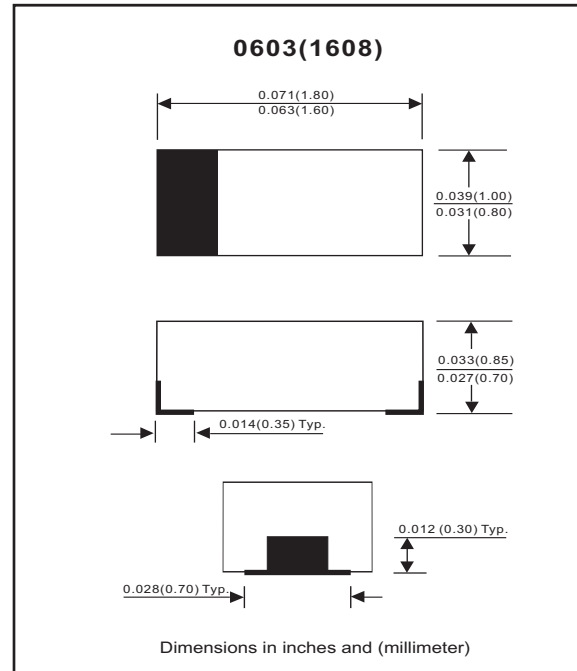

Maximum Rating (at TA = 25°C unless otherwise noted)

Parameter	Conditions	Symbol	Min	Typ	Max	Unit
Repetitive peak reverse voltage		V _{RRM}			100	V
Reverse voltage		V _R			75	V
Average forward current		I _O			150	mA
Forward current , surge peak	tp=1uS tp=1mS	I _{FSM}		4 1		A
Repetitive peak forward current		I _{FRM}			300	mA
Power Dissipation		P _D			150	mW
Storage temperature		T _{STG}	-40		+125	°C
Junction temperature		T _j	-40		+125	°C

Electrical Characteristics (at TA = 25°C unless otherwise noted)

Parameter	Conditions	Symbol	Min	Typ	Max	Unit
Forward voltage	I _F = 50 mA DC	V _F			1.0	V
Reverse current	V _R = 20 V V _R = 75 V	I _R			25 2.5	nA uA
Capacitance between terminals	f = 1MHz, and 0 VDC reverse voltage	C _T			4	pF
Reverse recovery time	I _F = I _R = 10 mA, R _L = 100 ohms, i _{rr} = 1mA	T _{rr}			4	nS

REV:B

RATING AND CHARACTERISTIC CURVES (CDSU4148-HF)

Fig. 1 - Forward characteristics

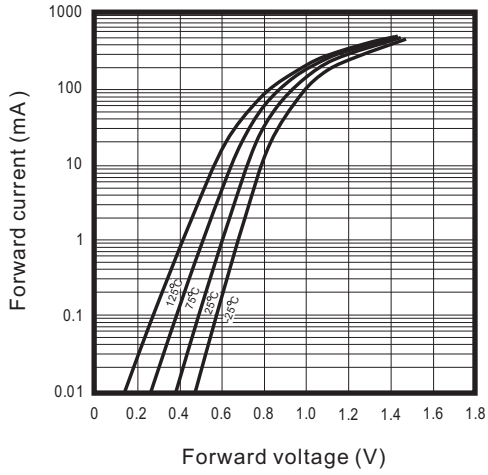

Fig. 2 - Reverse characteristics

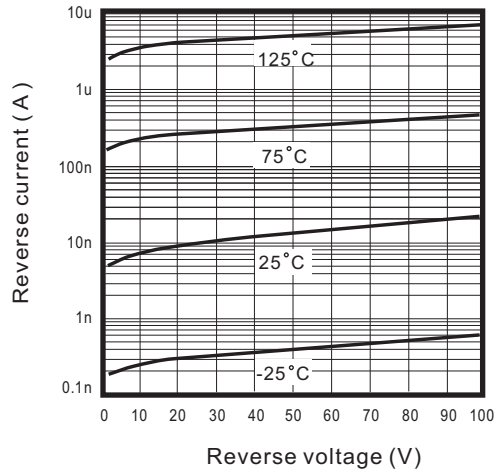

Fig. 3 - Capacitance between terminals characteristics

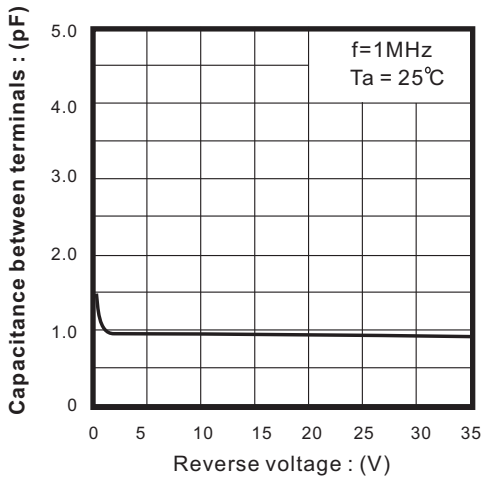
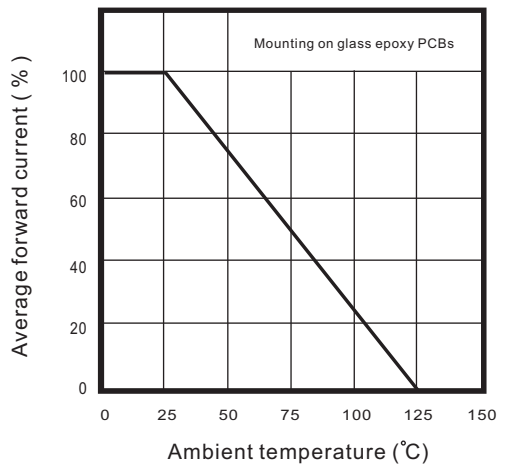
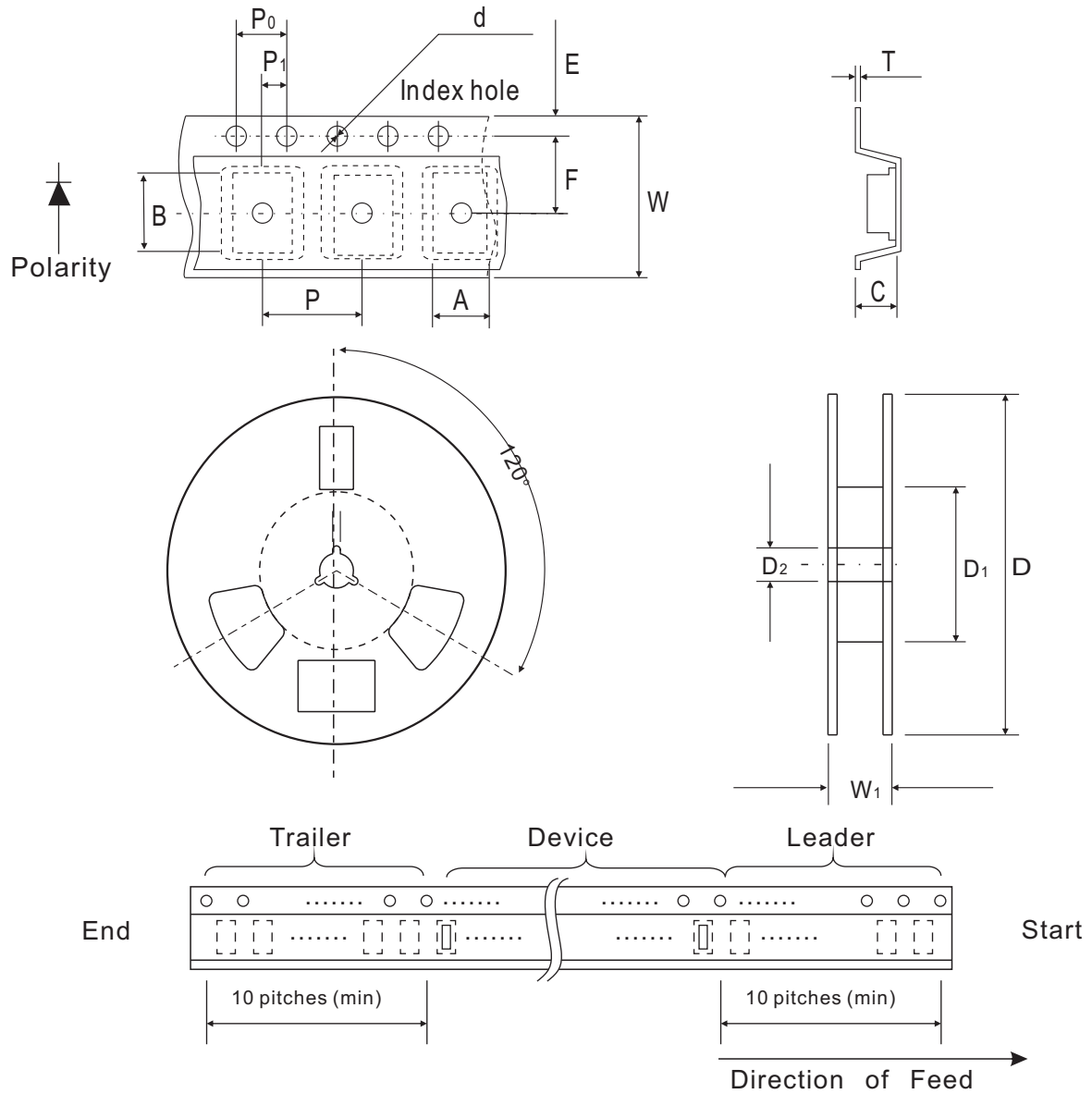

Fig. 4 - Current derating curve



Reel Taping Specification



U/0603	SYMBOL	A	B	C	d	D	D ₁	D ₂
	(mm)	1.00 ± 0.10	1.85 ± 0.10	1.00 ± 0.10	1.55 ± 0.05	178 ± 1	60.0 MIN.	13.0 ± 0.20
	(inch)	0.039 ± 0.004	0.073 ± 0.004	0.039 ± 0.004	0.061 ± 0.002	7.008 ± 0.04	2.362 MIN.	0.512 ± 0.008

U/0603	SYMBOL	E	F	P	P ₀	P ₁	T	W	W ₁
	(mm)	1.75 ± 0.10	3.50 ± 0.05	4.00 ± 0.10	4.00 ± 0.10	2.00 ± 0.05	0.23 ± 0.05	8.00 ± 0.20	13.5 MAX.
	(inch)	0.069 ± 0.004	0.138 ± 0.002	0.157 ± 0.004	0.157 ± 0.004	0.079 ± 0.004	0.009 ± 0.002	0.315 ± 0.008	0.531 MAX.

Suggested PAD Layout

SIZE	U/0603	
	(mm)	(inch)
A	1.70	0.067
B	0.60	0.024
C	0.80	0.031
D	2.30	0.091
E	1.10	0.043

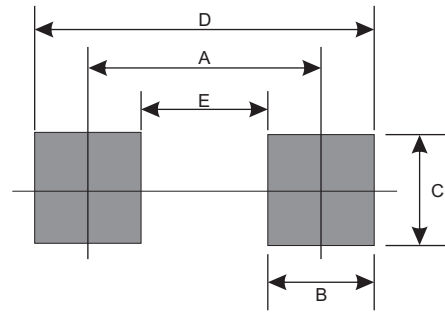

Standard Package

Case Type	Qty per Reel	Reel Size
	(Pcs)	(inch)
U/0603	4000	7