

## CPDER5V0U-HF (RoHS Device)



### Features

- Halogen free.
- Uni-directional ESD protection
- IEC 61000-4-2 15kV(contact), 20kV(air).
- Working voltage:5V
- Ultra small SMD package:0503.
- High component density.

### Mechanical data

- Case:0503 (1308) Standard package , molded plastic.
- Terminals: Gold plated, solderable per MIL-STD-750, method 2026.
- Marking Code: Cathode band & E05
- Mounting position: Any.
- Weight: 0.002 gram (approx.).

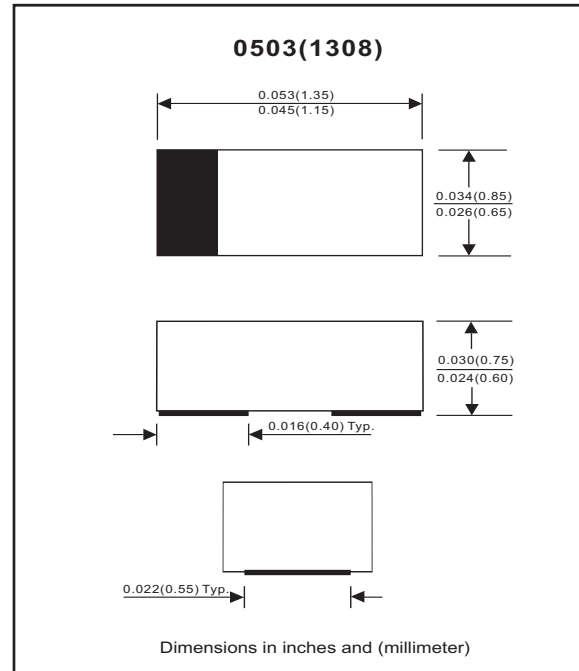

### Maximum Rating AND Electrical Characteristics (at TA=25 °C unless otherwise noted)

Parameter	Conditions	Symbol	Min	Typ	Max	Unit
Forward voltage	I <sub>F</sub> = 10mA	V <sub>F</sub>		0.8		V
Diode breakdown voltage	I <sub>R</sub> = 1mA	V <sub>BD</sub>	6			V
Leakage current	V <sub>R</sub> = 5V	I <sub>L</sub>		0.3	2.0	uA
Junction capacitance	V <sub>R</sub> = 0V, f = 1MHz	C <sub>T</sub>		90	120	pF
ESD capability	IEC 61000-4-2(air) IEC 61000-4-2(contact)	ESD			20 15	kV
Clamping voltage	I <sub>PP</sub> = 5A, T <sub>P</sub> =8/20us I <sub>PP</sub> = 16A, T <sub>P</sub> =8/20us	V <sub>C</sub>			9.8 12.5	V
Peak pulse power		P <sub>PP</sub>			200	W
Operation temperature		T <sub>J</sub>			125	°C
Storage temperature		T <sub>STG</sub>	-55		150	°C

## RATING AND CHARACTERISTIC CURVES (CPDER5V0U-HF)

Fig. 1 - 8/20us Peak pulse current wave form acc. IEC 61000-4-5

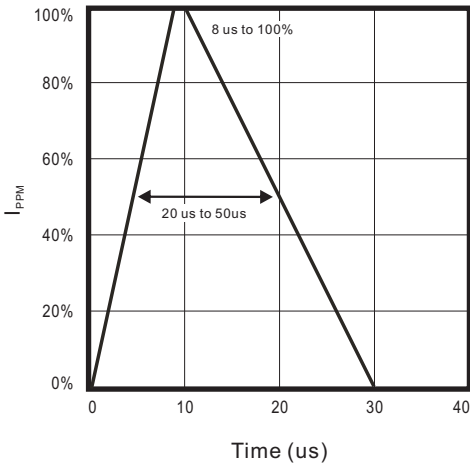

Fig. 2 - Power rating derating curve

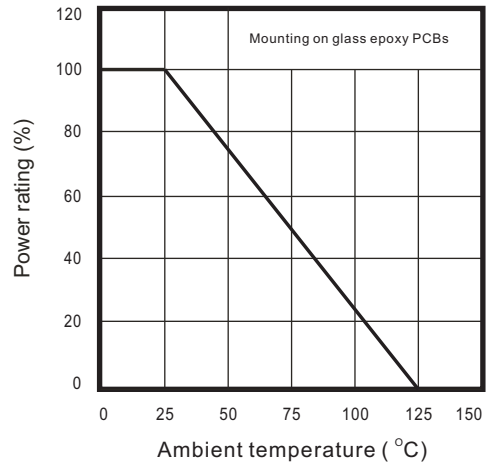

Fig. 3 - Clamping voltage vs. peak pulse current

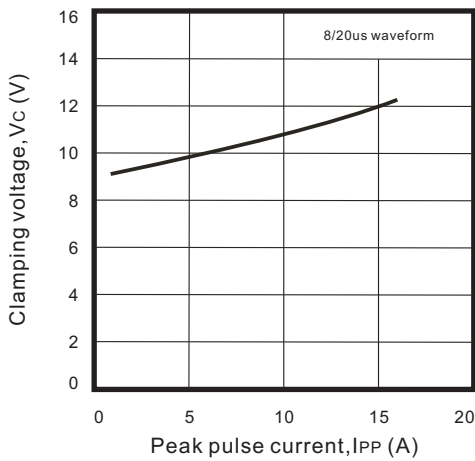

Fig. 4 - Forward voltage vs. forward current

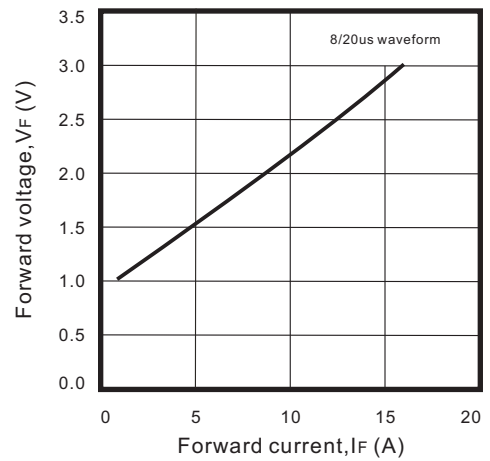

Fig. 5 - Capacitance between terminals characteristics

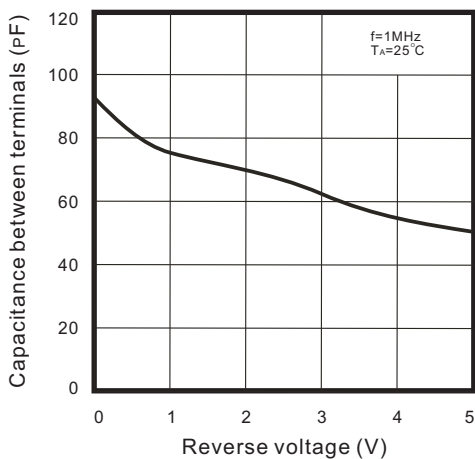
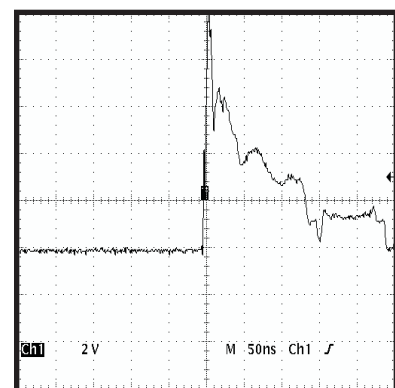
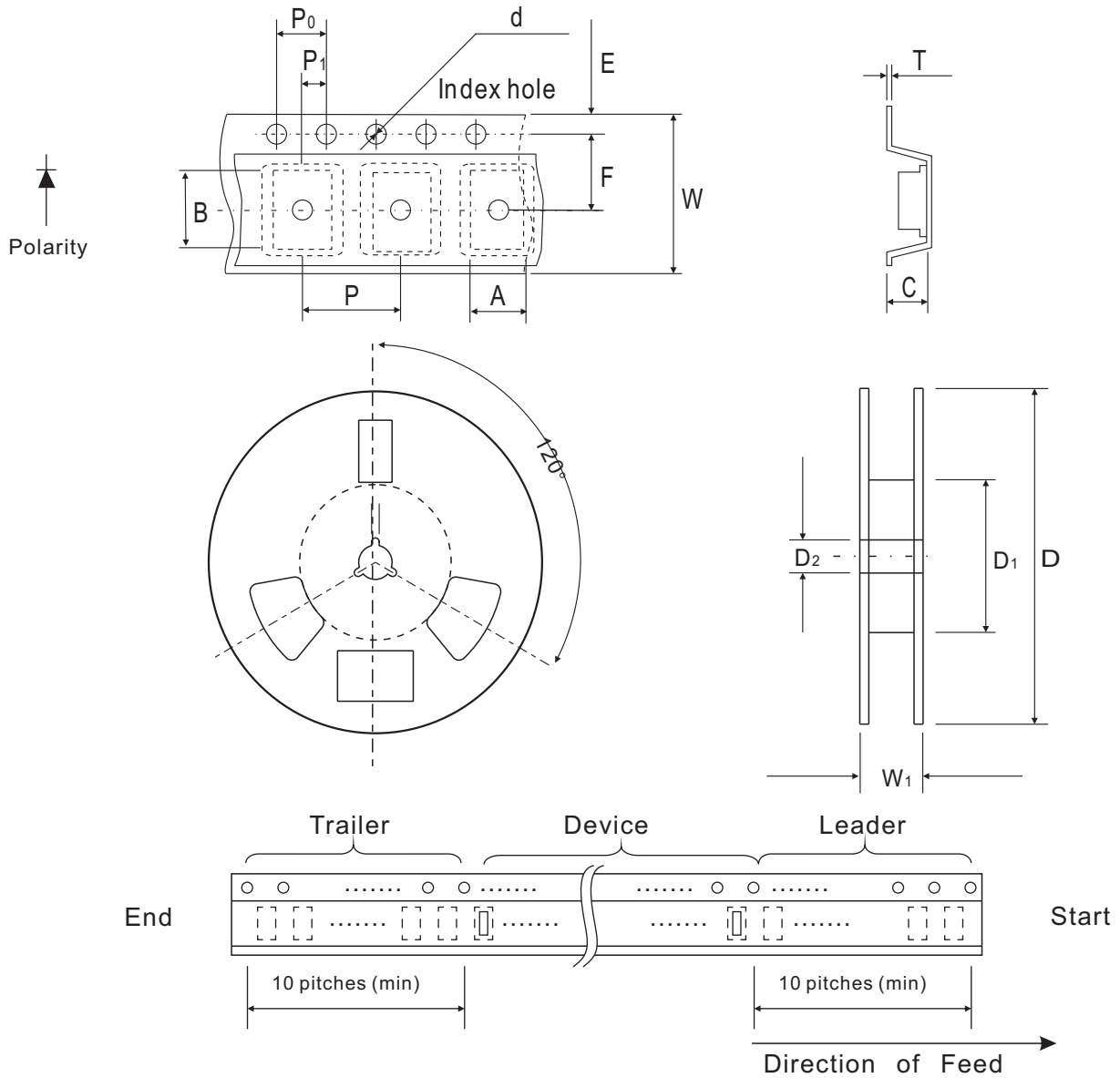

Fig. 6 - ESD Clamping (8kv Contant per IEC 61000-4-2)



## Reel Taping Specification



ER/0503	SYMBOL	A	B	C	d	D	D <sub>1</sub>	D <sub>2</sub>
	(mm)	0.90 ± 0.10	1.46 ± 0.10	0.80 ± 0.10	1.55 ± 0.05	178 ± 1	60.0 MIN.	13.0 ± 0.20
	(inch)	0.035 ± 0.004	0.057 ± 0.004	0.031 ± 0.004	0.061 ± 0.002	7.008 ± 0.04	2.362 MIN.	0.512 ± 0.008

ER/0503	SYMBOL	E	F	P	P <sub>0</sub>	P <sub>1</sub>	T	W	W <sub>1</sub>
	(mm)	1.75 ± 0.10	3.50 ± 0.05	4.00 ± 0.10	4.00 ± 0.10	2.00 ± 0.10	0.22 ± 0.05	8.00 ± 0.20	13.5 MAX.
	(inch)	0.069 ± 0.004	0.138 ± 0.002	0.157 ± 0.004	0.157 ± 0.004	0.079 ± 0.004	0.009 ± 0.002	0.315 ± 0.008	0.531 MAX.

## Marking Code

Part Number	Marking Code
CPDER5V0U-HF	E05



## Suggested PAD Layout

SIZE	ER/0503	
	(mm)	(inch)
A	0.85	0.033
B	0.55	0.022
C	0.85	0.033
D	1.40	0.055
E	0.30	0.011

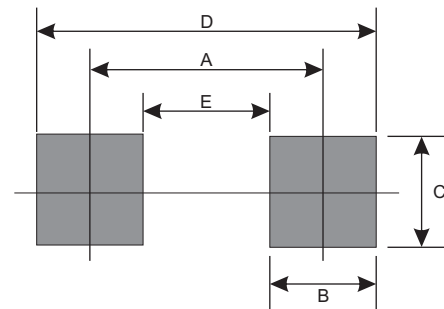

## Standard Package

Case Type	Qty per Reel	Reel Size
	(Pcs)	(inch)
ER/0503	5000	7