

## CDBA5817-HF Thru CDBA5819-HF

Reverse Voltage: 20 - 40 Volts  
 Forward Current: 1A or 3 A  
 RoHS Device

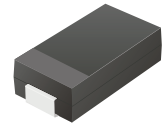

### Features

- Halogen free.
- Ideal for surface mount applications.
- Easy pick and place.
- Plastic package has Underwriters Lab, flammability classification 94V-0.
- Built-in strain relief.
- Low forward voltage drop.

### Mechanical data

- Case: JEDEC DO-214AC, molded plastic.
- Terminals: Solderable per MIL-STD-750, method 2026.
- Polarity: Color band denotes cathode end.
- Approx. weight: 0.056 grams

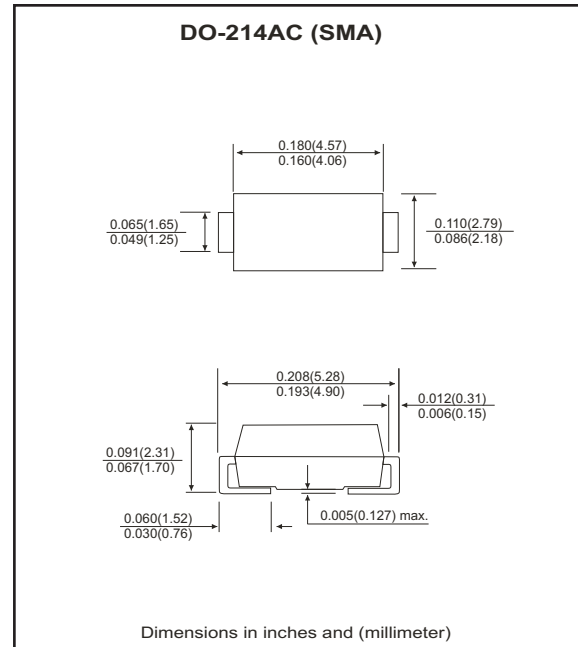

### Maximum Ratings(at TA=25°C unless otherwise noted)

Parameter	Symbol	CDBA5817-HF	CDBA5818-HF	CDBA5819-HF	Unit
Max. Repetitive Peak Reverse Voltage	V <sub>RRM</sub>	20	30	40	V
Max. DC Blocking Voltage	V <sub>DC</sub>	20	30	40	V
Max. RMS Voltage	V <sub>RMS</sub>	14	21	28	V
Peak Surge Forward Current 8.3ms single half sine-wave superimposed on rate load (JEDEC method)	I <sub>FSM</sub>	25			A
Max. Average Forward Current	I <sub>O</sub>	1			A
Max. Thermal Resistance	R <sub>θJL</sub>	20			°C/W
Storage Temperature	T <sub>STG</sub>	+125			°C
Max. Operating Junction Temperature	T <sub>J</sub>	-65 to +150			°C

### Electrical Characteristics (at TA=25°C unless otherwise noted)

Parameter	Symbol	CDBA5817-HF	CDBA5818-HF	CDBA5819-HF	Unit
Max. Forward Voltage at 1.0 A at 3.0 A	V <sub>F</sub>	0.45 0.75	0.550 0.775	0.60 0.90	V
Max. DC Reverse Current at Rated DC Blocking Voltage Ta = 25°C Ta = 100°C	I <sub>R</sub>	0.5 20			mA
Typical Junction Capacitance	C <sub>j</sub>	65			pF

## RATING AND CHARACTERISTIC CURVES (CDBA5817-HF Thru CDBA5819-HF)

Fig. 1 - Forward characteristics

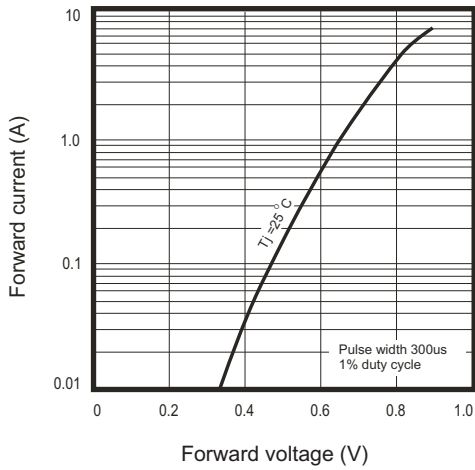

Fig. 2 - Reverse characteristics

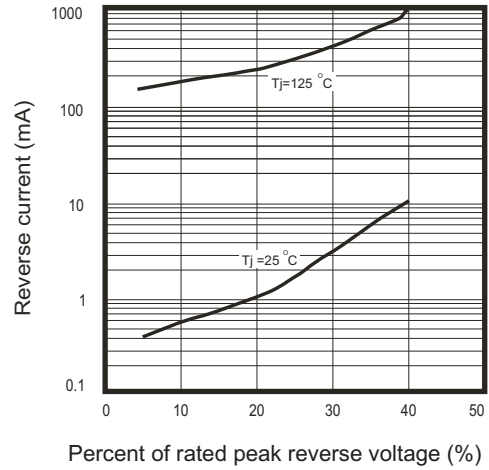

Fig.3 - Capacitance between terminals characteristics

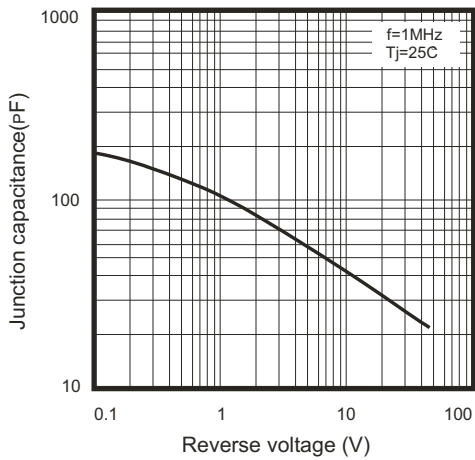

Fig.4 - Current derating curve

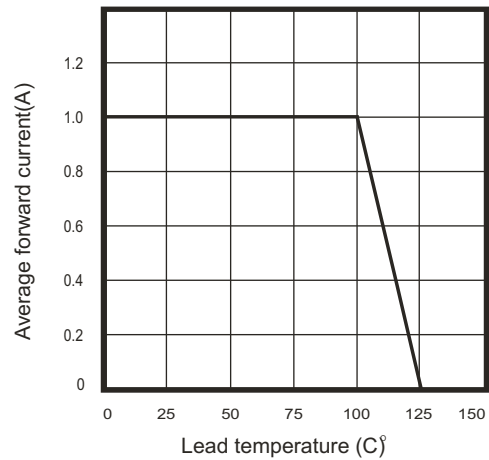
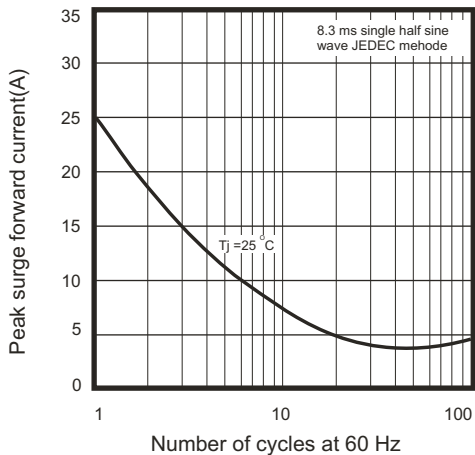
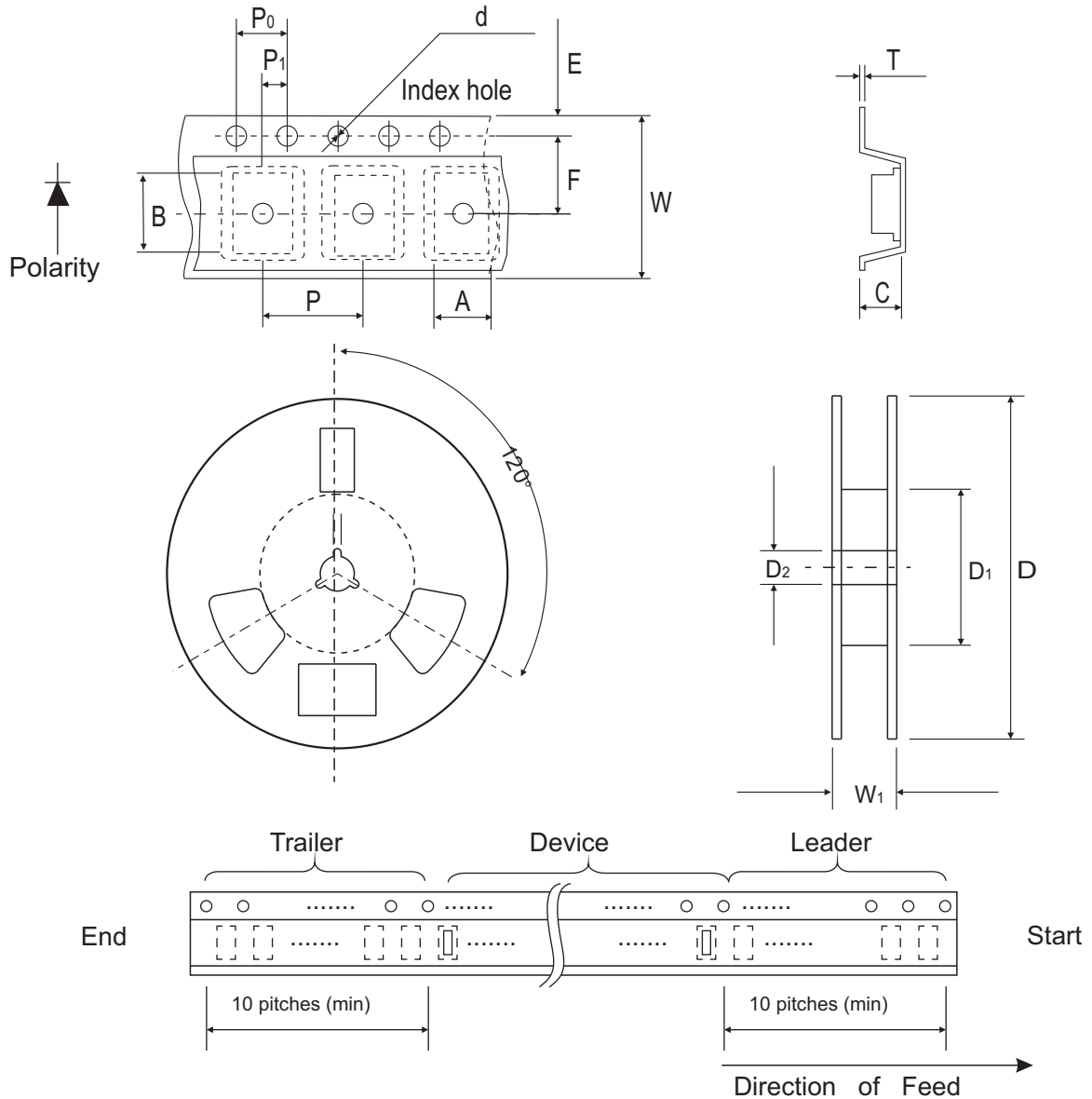

Fig.5 - Non repetitive peak forward surge current



## Reel Taping Specification



SMA (DO-214AC)	SYMBOL	A	B	C	d	D	D1	D2
	(mm)	2.70 (max)	5.30 (max)	2.66 (max)	1.50 ± 0.10	330	50.0 MIN.	13.5 ± 1.00
	(inch)	0.106 (max)	0.209 (max)	0.105 (max)	0.059 ± 0.004	12.99	1.969 MIN.	0.531 ± 0.039

SMA (DO-214AC)	SYMBOL	E	F	P	P0	P1	W	W1
	(mm)	1.75 ± 0.10	5.50 ± 0.05	4.00 ± 0.10	4.00 ± 0.10	2.00 ± 0.05	12.0 ± 0.20	18.4 (max)
	(inch)	0.689 ± 0.004	0.217 ± 0.002	0.157 ± 0.004	0.157 ± 0.004	0.079 ± 0.002	0.472 ± 0.008	0.724 (max)

## Marking Code

Part Number	Marking Code
CDBA5817-HF	5817
CDBA5818-HF	5818
CDBA5819-HF	5819



xxxx = Product type marking code

## Suggested PAD Layout

SIZE	DO-214AC(SMA)	
	(mm)	(inch)
A	3.80	0.150
B	1.60	0.063
C	2.80	0.110
D	5.40	0.213
E	2.20	0.087

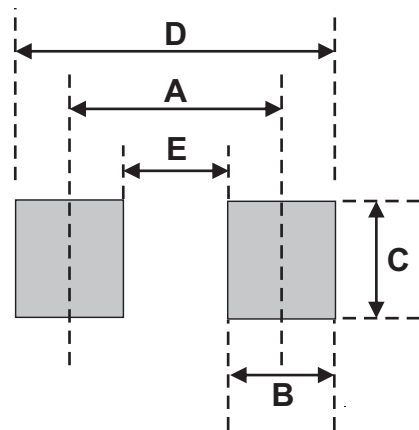

## Standard Package

Case Type	Qty per Reel	Reel Size
	(Pcs)	(inch)
DO-214AC (SMA)	5000	13