

CDST-99-HF/70-HF/56-HF

Reverse Voltage: 70 Volts

Forward Current: 200 mA

RoHS Device

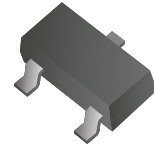

Features

- Halogen free.
- Design for mounting on small surface.
- High speed switching.
- High mounting capability, strong surge withstand, high reliability.

Mechanical data

- Case: SOT-23, molded plastic.
- Terminals: solderable per MIL-STD-750, method 2026.
- Approx. weight: 0.0078 grams

Circuit diagram

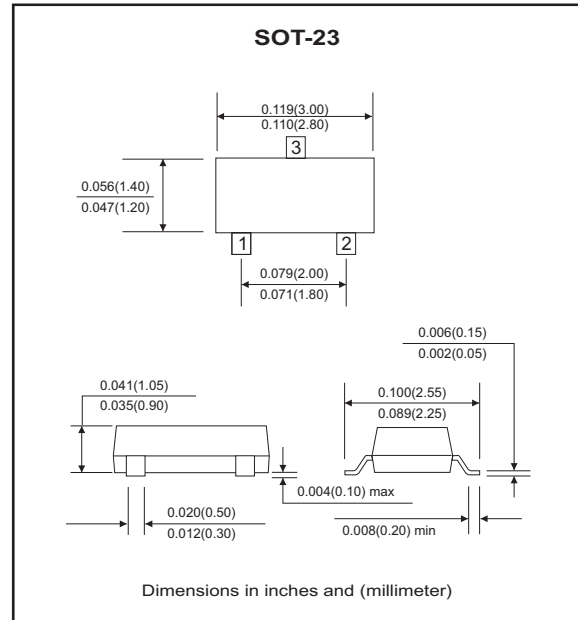
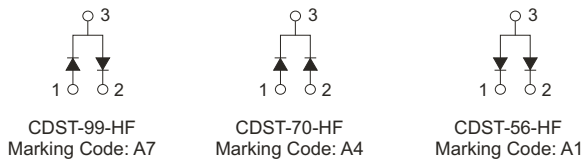

Maximum Ratings (at Ta=25°C unless otherwise noted)

Parameter	Symbol	Value	Units
Reverse voltage	V_R	70	V
Forward current	I_F	200	mA
Peak surge forward current	I_{FSM}	500	mA
Power dissipation	P_D	225	mW
Thermal resistance, junction to ambient	$R_{\theta JA}$	556	°C/W
Maximum junction temperature	T_J	150	°C
Storage temperature	T_{STG}	-55 to +150	°C

Electrical Characteristics (at Ta=25°C unless otherwise noted)

Parameter	Symbol	Conditions	Min.	Max.	Units
Reverse breakdown voltage	V_{BR}	$I_R=100\mu A$	70		V
Forward voltage	V_F	@ $I_F=1mA$ @ $I_F=10mA$ @ $I_F=50mA$ @ $I_F=150mA$		0.715 0.855 1.0 1.25	V
Reverse current	I_R	@ $V_R=70V$		2.5	μA
Reverse recovery time	t_{rr}	$I_F=I_R=10mA$, $I_{rr}=0.1 \times I_R$, $R_L=100\Omega$		6	nS
Diode capacitance	C_T	$V_R=0V$, $f=1.0MHz$		1.5	pF

RATING AND CHARACTERISTIC CURVES (CDST-99-HF/70-HF/56-HF)

Fig.1 Forward Characteristics

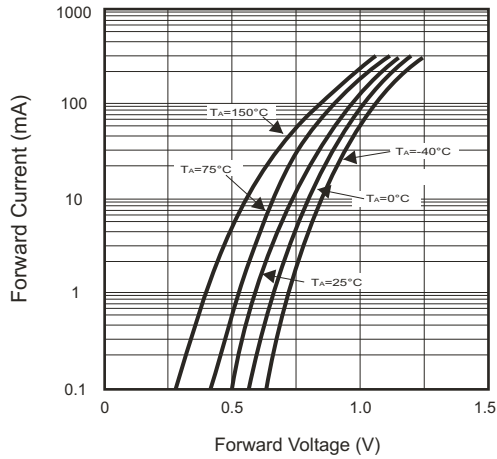

Fig.2 Reverse Characteristics

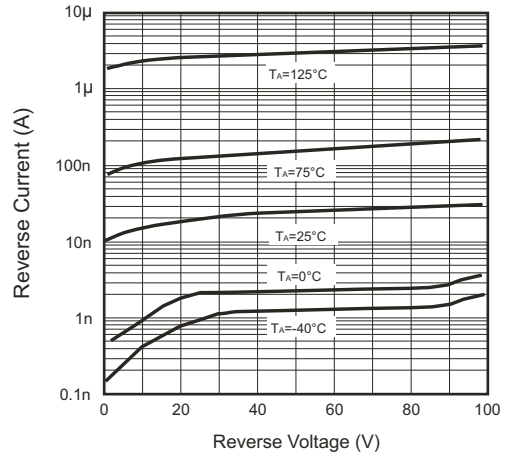

Fig.3 Capacitance Between Terminals Characteristics

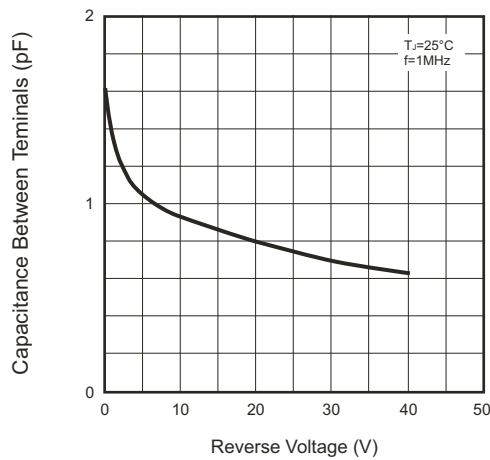
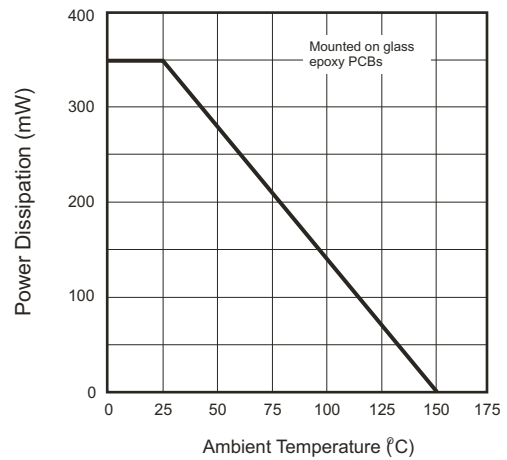
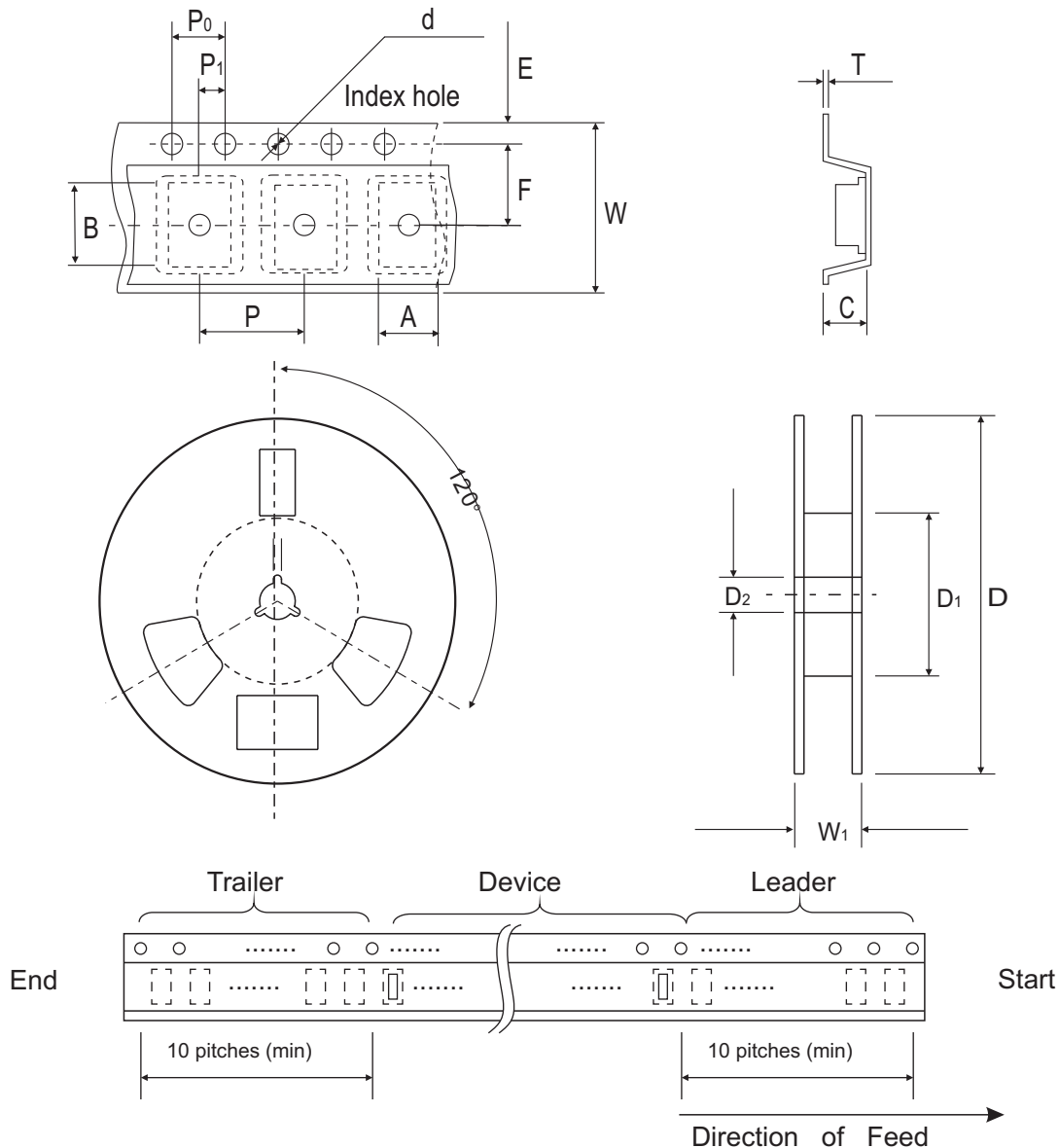

Fig.4 Power Derating Curve



Reel Taping Specification



SOT-23	SYMBOL	A	B	C	d	D	D ₁	D ₂
	(mm)	3.10 ± 0.10	2.85 ± 0.10	1.40 ± 0.10	1.55 ± 0.10	178 ± 1	50.0 MIN.	13.0 ± 0.20
	(inch)	0.122 ± 0.004	0.112 ± 0.004	0.055 ± 0.004	0.061 ± 0.004	7.008 ± 0.04	1.969 MIN.	0.512 ± 0.008

SOT-23	SYMBOL	E	F	P	P ₀	P ₁	W	W ₁
	(mm)	1.75 ± 0.10	3.50 ± 0.05	4.00 ± 0.10	4.00 ± 0.10	2.00 ± 0.05	8.00 ± 0.30	14.4 MAX.
	(inch)	0.069 ± 0.004	0.138 ± 0.002	0.157 ± 0.004	0.157 ± 0.004	0.079 ± 0.002	0.315 ± 0.012	0.567 MAX.

Marking Code

Part Number	Marking Code
CDST-99-HF	A7
CDST-70-HF	A4
CDST-56-HF	A1

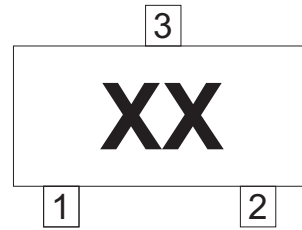

xx = Product type marking code

Suggested PAD Layout

SIZE	SOT-23	
	(mm)	(inch)
A	0.80	0.031
B	1.90	0.075
C	2.02	0.080
D	2.82	0.111

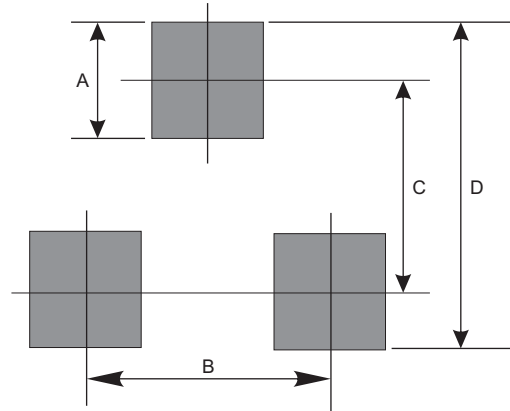

Standard Package

Case Type	Qty per Reel	Reel Size
	(Pcs)	(inch)
SOT-23	3000	7