

CPDU Series-HF(RoHS Device)

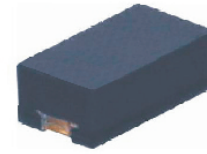

Features

- Halogen free.
- Bi-directional ESD protection.
(16kV) IEC 61000-4-2 rating.
- Surface mount package.
- High component density.

Mechanical data

- Case: 0603(1608) standard package, molded plastic.
- Terminals: Gold plated, solderable per MIL-STD-750, method 2026.
- Marking Code:
 - CPDU5V0-HF: E05
 - CPDU12V-HF: E12
 - CPDU24V-HF: E24
- Mounting position: Any.
- Weight: 0.003 gram(approx.).

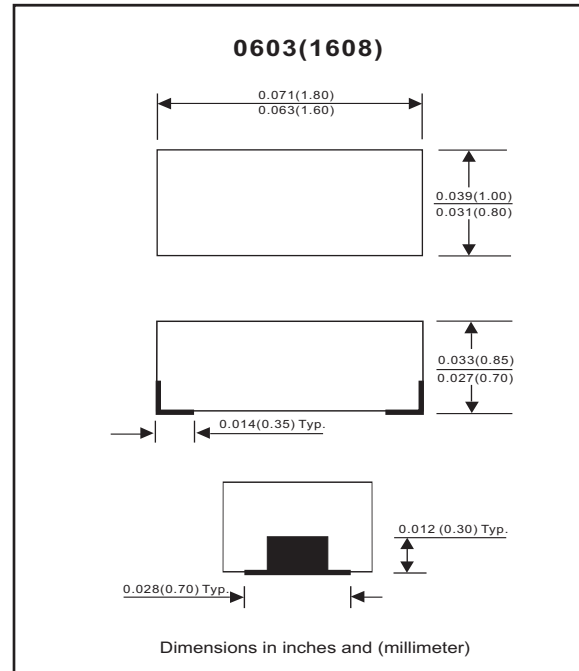

Electrical Characteristics (at TA=25°C unless otherwise noted)

Parameter	Conditions	Symbol	Min	Typ	Max	Unit
Diode breakdown voltage	CPDU5V0-HF CPDU12V-HF CPDU24V-HF I _R = 1mA	V _{BD}	5.1 13 25	7.0 17 28		V
Leakage current	CPDU5V0-HF CPDU12V-HF CPDU24V-HF V _R = 5V V _R = 12V V _R = 24V	I _L		0.1	2.0	uA
Junction capacitance	CPDU5V0-HF CPDU12V-HF CPDU24V-HF V _R = 0V, f = 1MHz	C _T		15 12 10	20 --- ---	pF
ESD capability	CPDU Series-HF IEC 61000-4-2(air) IEC 61000-4-2(contact)	ESD			16 8	kV
Clamping voltage	CPDU5V0-HF CPDU12V-HF CPDU24V-HF I _{PP} = 5A, T _P = 8/20us I _{PP} = 1A, T _P = 8/20us I _{PP} = 1A, T _P = 8/20us	V _C			15 25 47	V
Peak pulse power	CPDU5V0-HF CPDU12V-HF CPDU24V-HF T _P = 8/20us	P _{PP}			75 25 47	W
Operation temperature	CPDU Series-HF	T _j			125	°C
Storage temperature	CPDU Series-HF	T _{STG}	-55		150	°C

RATING AND CHARACTERISTIC CURVES (CPDU Series-HF)

Fig. 1 - 8/20us Peak pulse current wave form acc. IEC 61000-4-5

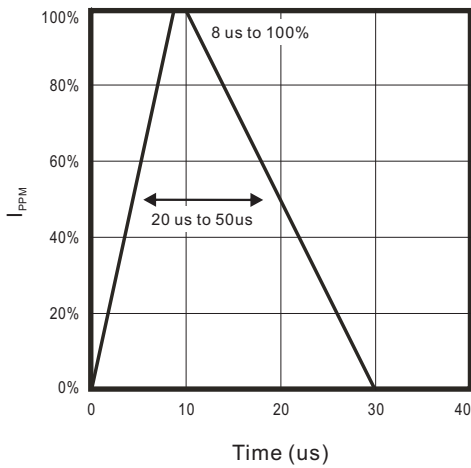

Fig. 2 - Reverse characteristics

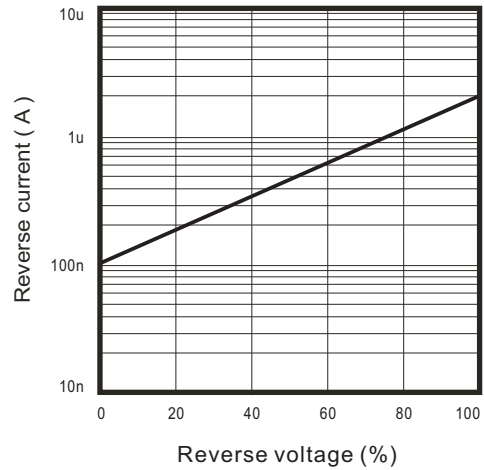

Fig. 3 - Capacitance between terminals characteristics

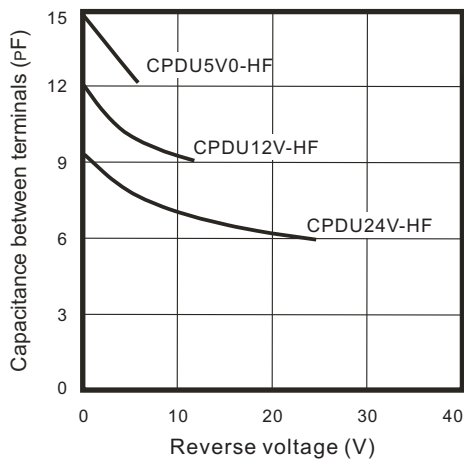
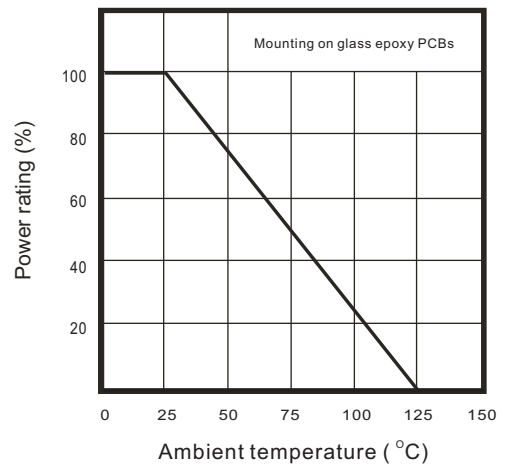

Fig. 4 - Power rating derating curve



Reel Taping Specification



U/0603	SYMBOL	A	B	C	d	D	D ₁	D ₂
	(mm)	1.00 ± 0.10	1.85 ± 0.10	1.00 ± 0.10	1.55 ± 0.05	178 ± 1	60.0 MIN.	13.0 ± 0.20
	(inch)	0.039 ± 0.004	0.073 ± 0.004	0.039 ± 0.004	0.061 ± 0.002	7.008 ± 0.04	2.362 MIN.	0.512 ± 0.008

U/0603	SYMBOL	E	F	P	P ₀	P ₁	T	W	W ₁
	(mm)	1.75 ± 0.10	3.50 ± 0.05	4.00 ± 0.10	4.00 ± 0.10	2.00 ± 0.05	0.23 ± 0.05	8.00 ± 0.20	13.5 MAX.
	(inch)	0.069 ± 0.004	0.138 ± 0.002	0.157 ± 0.004	0.157 ± 0.004	0.079 ± 0.004	0.009 ± 0.002	0.315 ± 0.008	0.531 MAX.

Marking Code

Part Number	Marking Code
CPDU5V0-HF	E05
CPDU12V-HF	E12
CPDU24V-HF	E24



xxx = Product type marking code

Suggested PAD Layout

SIZE	U/0603	
	(mm)	(inch)
A	1.70	0.067
B	0.60	0.024
C	0.80	0.031
D	2.30	0.091
E	1.10	0.043

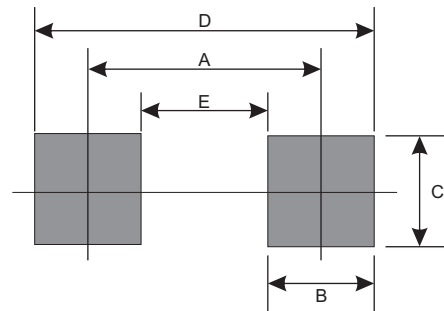

Standard Package

Case Type	Qty per Reel	Reel Size
	(Pcs)	(inch)
U/0603	4000	7