

## CDBM120L-HF Thru. CDBM140L-HF

Reverse Voltage: 20 to 40 Volts

Forward Current: 1.0 Amp

RoHS Device

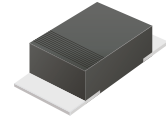

### Features

- Halogen free.
- Ideal for surface mount applications.
- Easy pick and place.
- Plastic package has Underwriters Lab. flammability classification 94V-0.
- Exceeds environmental standard MIL-S-19500/228.
- Low leakage current.

### Mechanical data

- Case: Mini SMA/SOD-123, molded plastic.
- Terminals: solderable per MIL-STD-750, method 2026.
- Polarity: Color band denotes cathode end.
- Approx. weight: 0.027 grams

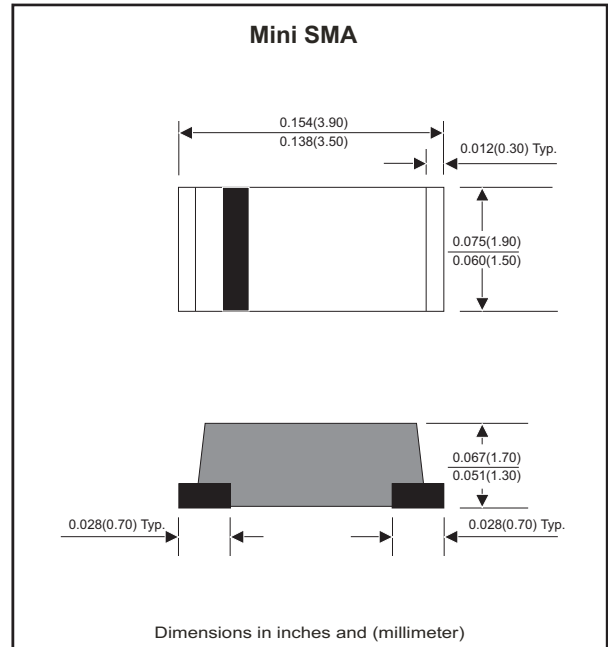

### Maximum Ratings and Electrical Characteristics

Parameter	Symbol	CDBM120L-HF	CDBM130L-HF	CDBM140L-HF	Units
Max. Repetitive peak reverse voltage	$V_{RRM}$	20	30	40	V
Max. DC blocking voltage	$V_R$	20	30	40	V
Max. RMS voltage	$V_{RMS}$	14	21	28	V
Peak surge forward current, 8.3ms single half sine-wave superimposed on rate load (JEDEC method)	$I_{FSM}$	30			A
Max. average forward current	$I_o$	1.0			A
Max. instantaneous forward voltage at $I_F=1.0A$	$V_F$	0.38	0.40	0.40	V
Max. DC reverse current at $T_A=25^{\circ}C$	$I_R$	1.0			mA
Max. thermal resistance (Note 1)	$R_{\theta JA}$	42			$^{\circ}C/W$
Typ. Diode Junction capacitance (F=1MHz and applied 4V DC reverse voltage)	$C_J$	130			$^{\circ}C$
Max. operating junction temperature	$T_J$	-55 to +100			$^{\circ}C$
Storage temperature	$T_{STG}$	-65 to +175			$^{\circ}C$

Notes: 1. Thermal resistance from junction to ambient and junction to lead, P.C.B. mounted on 0.2x0.2 inch<sup>2</sup> copper pad area.

## RATING AND CHARACTERISTIC CURVES (CDBM120L-HF thru CDBM140L-HF)

Fig.1 Typical Forward Characteristics

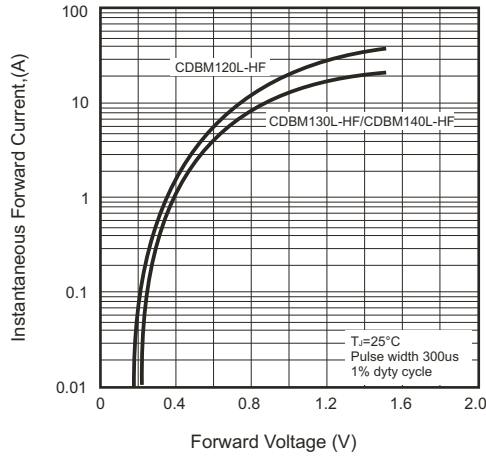

Fig.2 Typical Forward Current Derating Curve

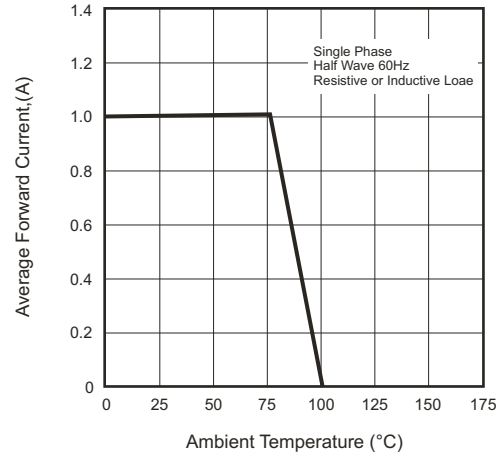

Fig.3 Typical Reverse Characteristics

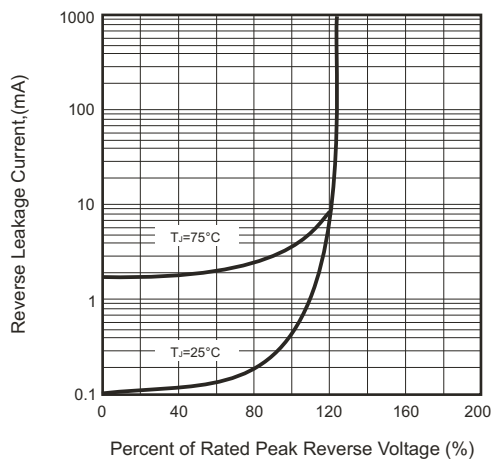

Fig.4 Max. Non-repetitive Forward Surge Current

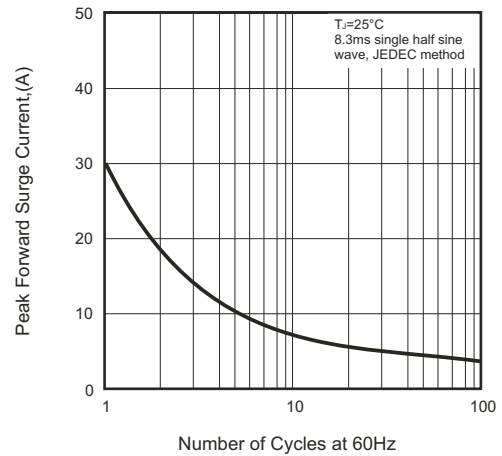
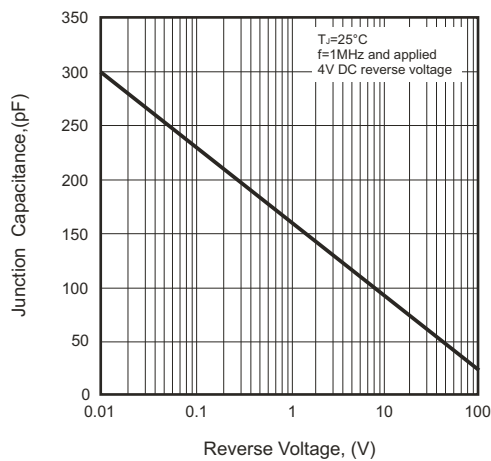
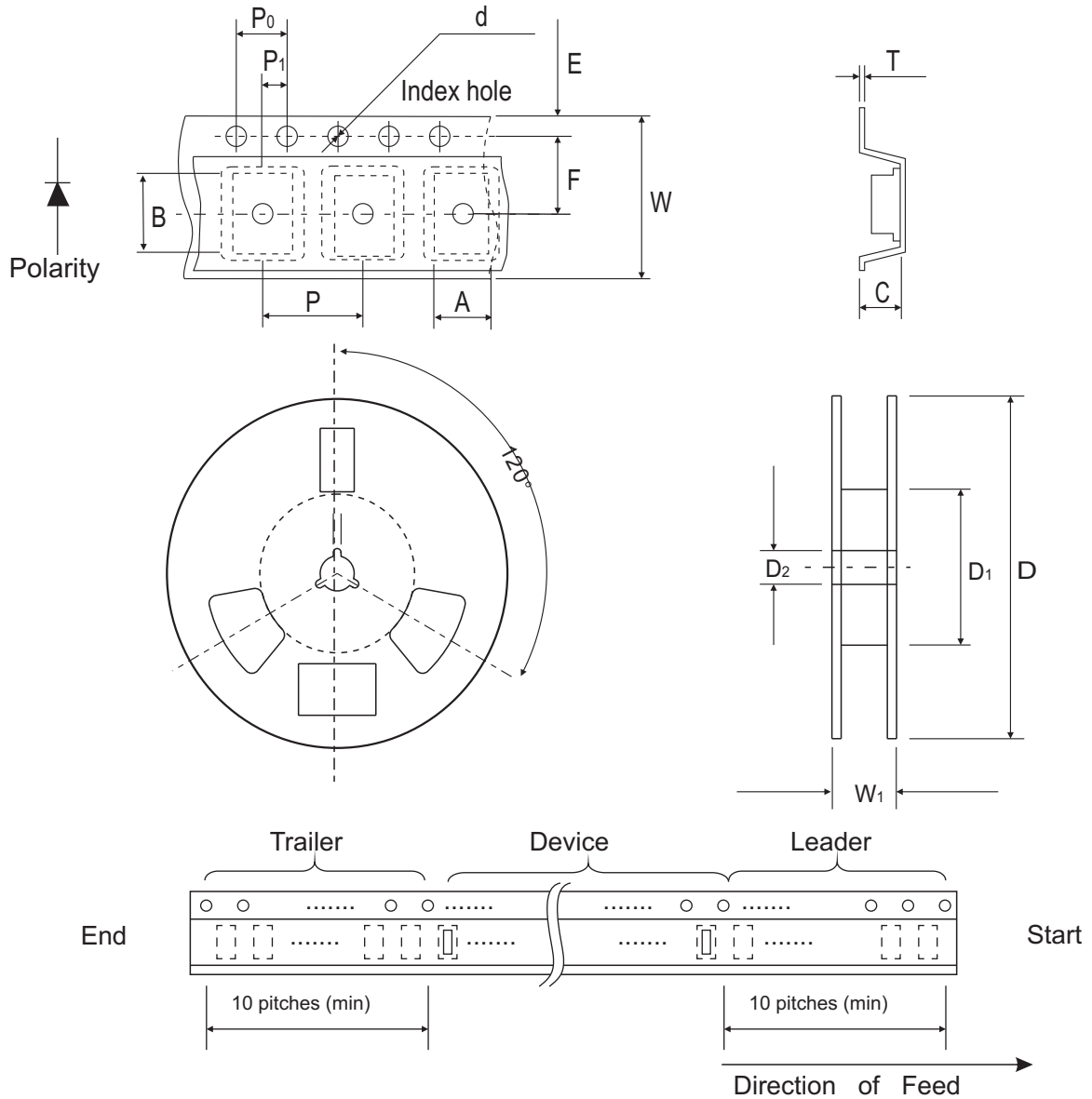

Fig.5 Typical Junction Capacitance



## Reel Taping Specification



Mini-SMA/SOD-123	SYMBOL	A	B	C	d	D	D1	D2
	(mm)	1.90 ± 0.10	3.90 ± 0.10	1.68 ± 0.10	1.50 ± 0.10	178 ± 2.00	62.0 MIN.	13.0 ± 0.50
	(inch)	0.075 ± 0.04	0.154 ± 0.04	0.066 ± 0.04	0.059 ± 0.004	7.00 ± 0.079	2.440 MIN.	0.512 ± 0.020

Mini-SMA/SOD-123	SYMBOL	E	F	P	P0	P1	T	W	W1
	(mm)	1.75 ± 0.10	3.50 ± 0.10	4.00 ± 0.10	4.00 ± 0.10	2.00 ± 0.10	0.23 ± 0.10	8.00 ± 0.30	11.40 ± 1.0
	(inch)	0.069 ± 0.004	0.138 ± 0.004	0.157 ± 0.004	0.157 ± 0.004	0.079 ± 0.004	0.009 ± 0.004	0.315 ± 0.012	0.449 ± 0.004

## Marking Code

Part Number	Marking Code
CDBM120L-HF	L2
CDBM130L-HF	L3
CDBM140L-HF	L4



XX = Product type marking code

## Suggested PAD Layout

SIZE	Mini-SMA/SOD-123	
	(mm)	(inch)
A	3.30	0.130
B	1.40	0.055
C	1.90	0.075
D	4.70	0.185
E	1.90	0.075

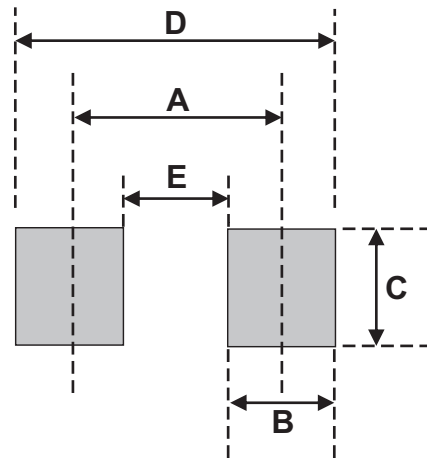

## Standard Package

Case Type	Qty per Reel	Reel Size
	(Pcs)	(inch)
Mini-SMA/SOD-123	2500	7