

CPDURT5V0C-HF

RoHS Device
Halogen Free

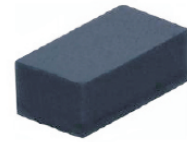

Features

- Bi-directional ESD protection.
- Surface mount package.
- Extremely thin / leadless package.
- Low profile package is 30% thinner than standards 0603
- Operating voltage: 5V.

Mechanical data

- Case: 0603/SOD-523F standard package, molded plastic.
- Terminals: Gold plated, solderable per MIL-STD-750, method 2026.
- Marking code: E05
- Mounting Position: Any
- Weight: 0.0019 grams approx.

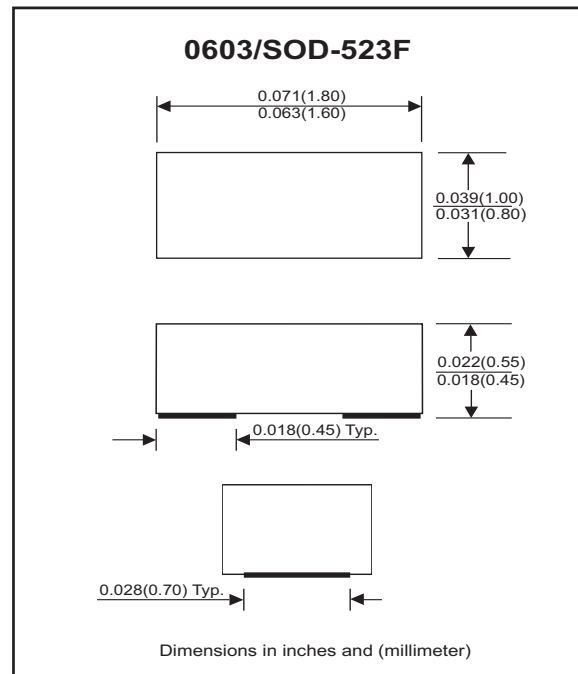

Electrical Characteristics (at TA=25 °C unless otherwise noted)

Parameter	Conditions	Symbol	Min	Typ	Max	Unit
Diode breakdown voltage	I _R = 1mA	V _{BD}	6.1	7.0		V
Leakage current	V _R = 5V	I _L		0.1	2.0	uA
Junction capacitance	V _R = 0V, f = 1MHz	C _T		25	30	pF
ESD capability	IEC 61000-4-2(air)	ESD			16	kV
	IEC 61000-4-2(contact)	ESD			8	kV
Clamping Voltage	I _{PP} = 1 A, t _p =8/20us	V _c			9	V
	I _{PP} = 4 A, t _p =8/20us	V _c			14.5	V
Peak Pulse Power	T _P =8/20us	P _{PP}			58	W
Operation temperature		T _j			125	°C
Storage temperature		T _{STG}	-55		150	°C

RATING AND CHARACTERISTIC CURVES (CPDURT5V0C-HF)

Fig. 1 - Reverse characteristics

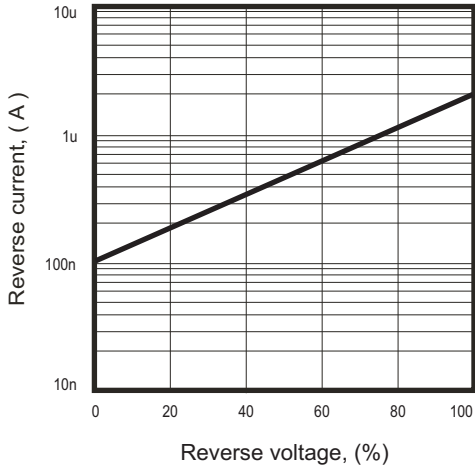

Fig. 2 - Capacitance between terminals characteristics

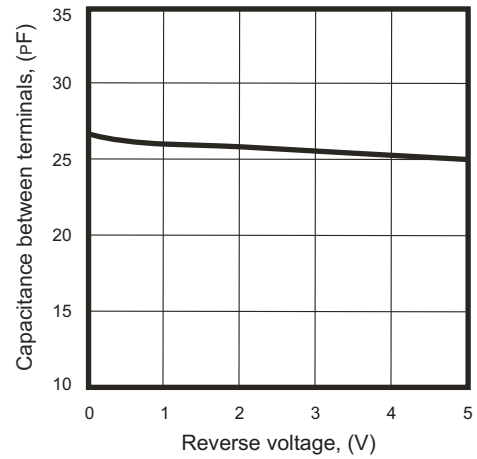

Fig.3 - Clamping voltage vs. peak pulse current

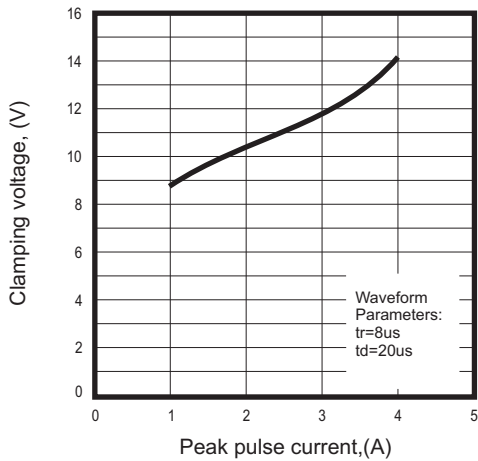
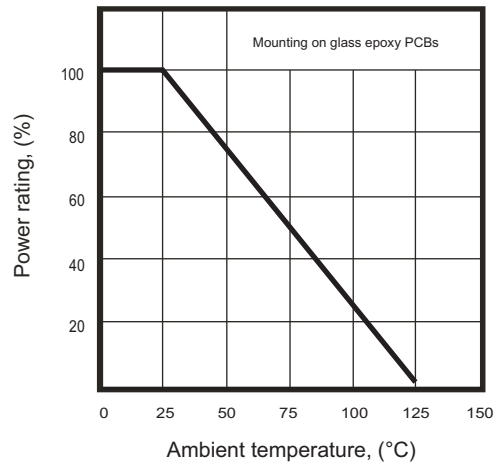
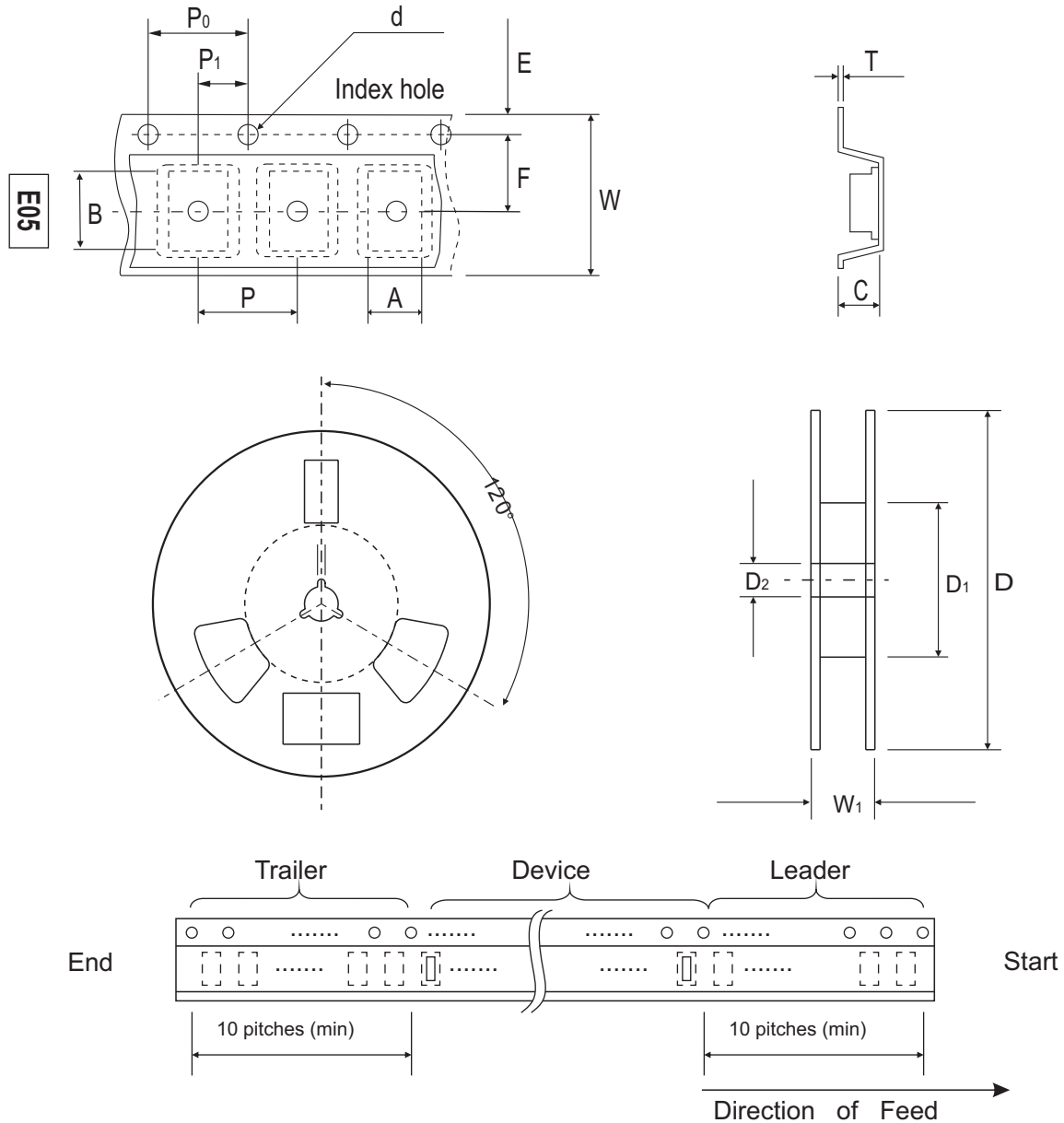

Fig. 4 - Power rating derating curve



Reel Taping Specification



0603 (SOD-523F)	SYMBOL	A	B	C	d	D	D ₁	D ₂
	(mm)	1.05 ± 0.05	1.96 ± 0.05	0.57 ± 0.05	1.50 + 0.10	178 ± 1	60.0 MIN.	13.0 ± 0.20
	(inch)	0.041 ± 0.002	0.077 ± 0.002	0.022 ± 0.002	0.059 ± 0.004	7.008 ± 0.04	2.362 MIN.	0.512 ± 0.008

0603 (SOD-523F)	SYMBOL	E	F	P	P ₀	P ₁	T	W	W ₁
	(mm)	1.75 ± 0.10	3.50 ± 0.05	4.00 ± 0.10	4.00 ± 0.05	2.00 ± 0.05	0.20 ± 0.03	8.00 ± 0.20	13.5 MAX.
	(inch)	0.069 ± 0.004	0.138 ± 0.002	0.157 ± 0.004	0.157 ± 0.004	0.079 ± 0.002	0.008 ± 0.001	0.315 ± 0.008	0.531 MAX.

Marking Code

Part Number	Marking Code
CPDURT5V0C-HF	E05

E05

Suggested PAD Layout

SIZE	0603/SOD-523F	
	(mm)	(inch)
A	1.25	0.049
B	0.60	0.024
C	1.00	0.039
D	1.85	0.073
E	0.65	0.026

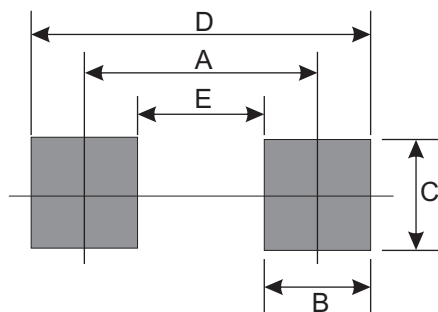

Standard Package

Case Type	Qty Per Reel	Reel Size
	(Pcs)	(inch)
URT/0603	4,000	7