

## CPDQR24V0U-HF

**RoHS Device**  
**Halogen Free**

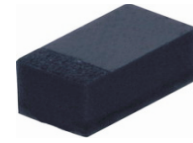

### Features

- Uni-directional ESD protection.
- Surface mount package.
- Ultra small SMD package:0402.
- High component density.

### Mechanical data

- Case: 0402/SOD-923F standard package, molded plastic.
- Terminals: Gold plated, solderable per MIL-STD-750,method 2026.
- Marking Code:  
CPDQR5V0U-HF: E4
- Mounting position: Any.
- Weight: 0.001 gram(approx.).

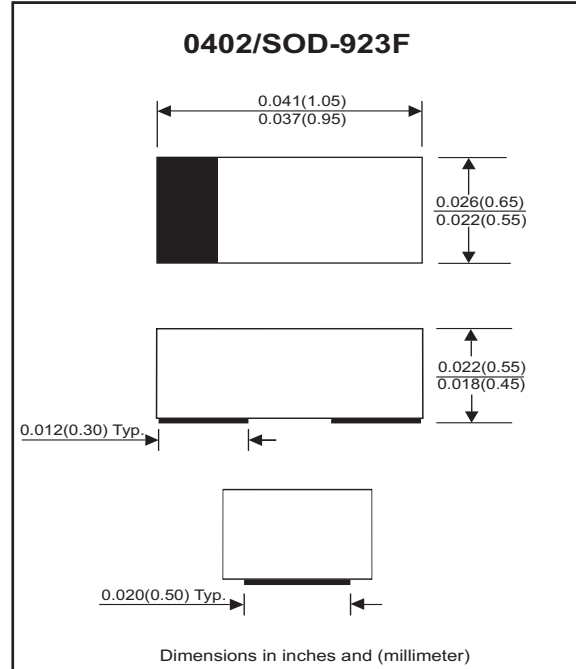

### Maximum Rating AND Electrical Characteristics (at TA=25 °C unless otherwise noted)

Parameter	Conditions	Symbol	Min	Typ	Max	Unit
Forward voltage	I <sub>F</sub> = 10mA	V <sub>F</sub>		0.8	1.2	V
Diode breakdown voltage	I <sub>R</sub> = 1mA	V <sub>BD</sub>	26.5			V
Leakage current	V <sub>R</sub> = 24V	I <sub>L</sub>			0.25	uA
Junction capacitance	V <sub>R</sub> = 0V, f = 1MHz	C <sub>T</sub>			35	pF
ESD capability	IEC 61000-4-2(air) IEC 61000-4-2(contact)	ESD			20 15	kV
Clamping voltage	I <sub>PP</sub> = 3A, T <sub>P</sub> =8/20us	V <sub>C</sub>			50	V
Peak pulse power		P <sub>PP</sub>			150	W
Operation temperature		T <sub>J</sub>			125	°C
Storage temperature		T <sub>STG</sub>	-55		150	°C

## RATING AND CHARACTERISTIC CURVES (CPDQR24V0U-HF)

Fig. 1 - 8/20us Peak pulse current wave form acc. IEC 61000-4-5

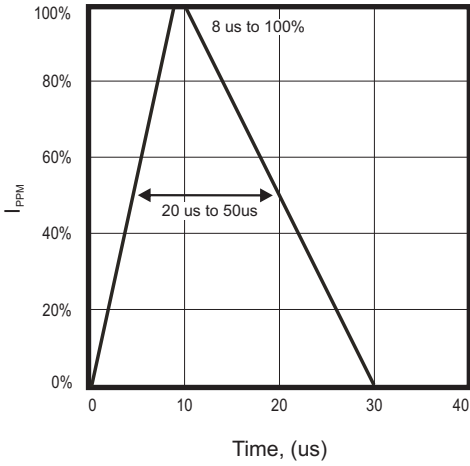

Fig. 2 - Power rating derating curve

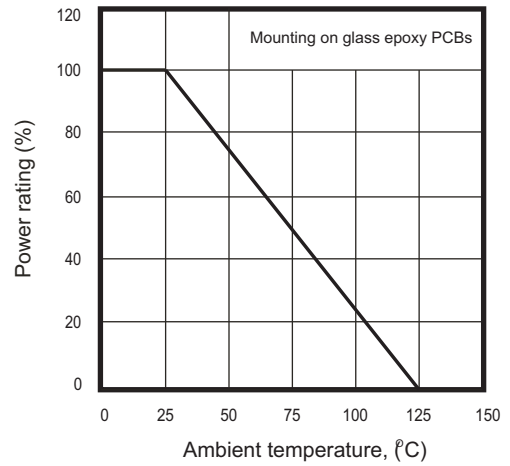

Fig. 3 - Clamping voltage vs. peak pulse current

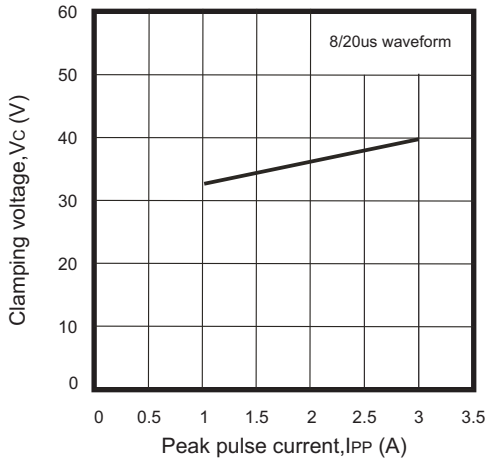

Fig. 4 - Forward voltage vs. forward current

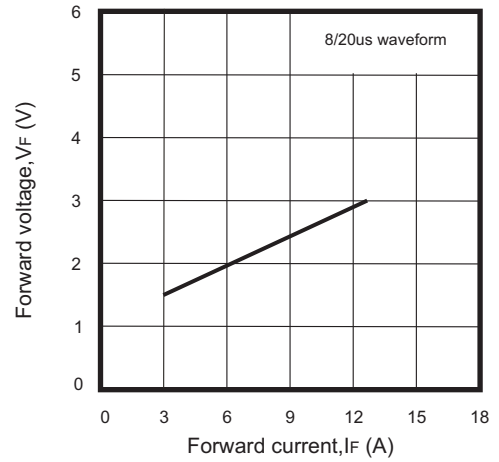
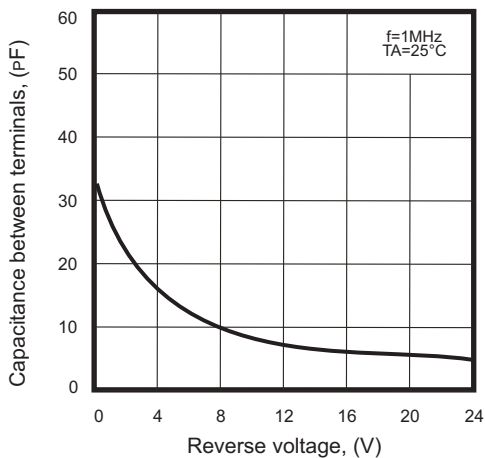
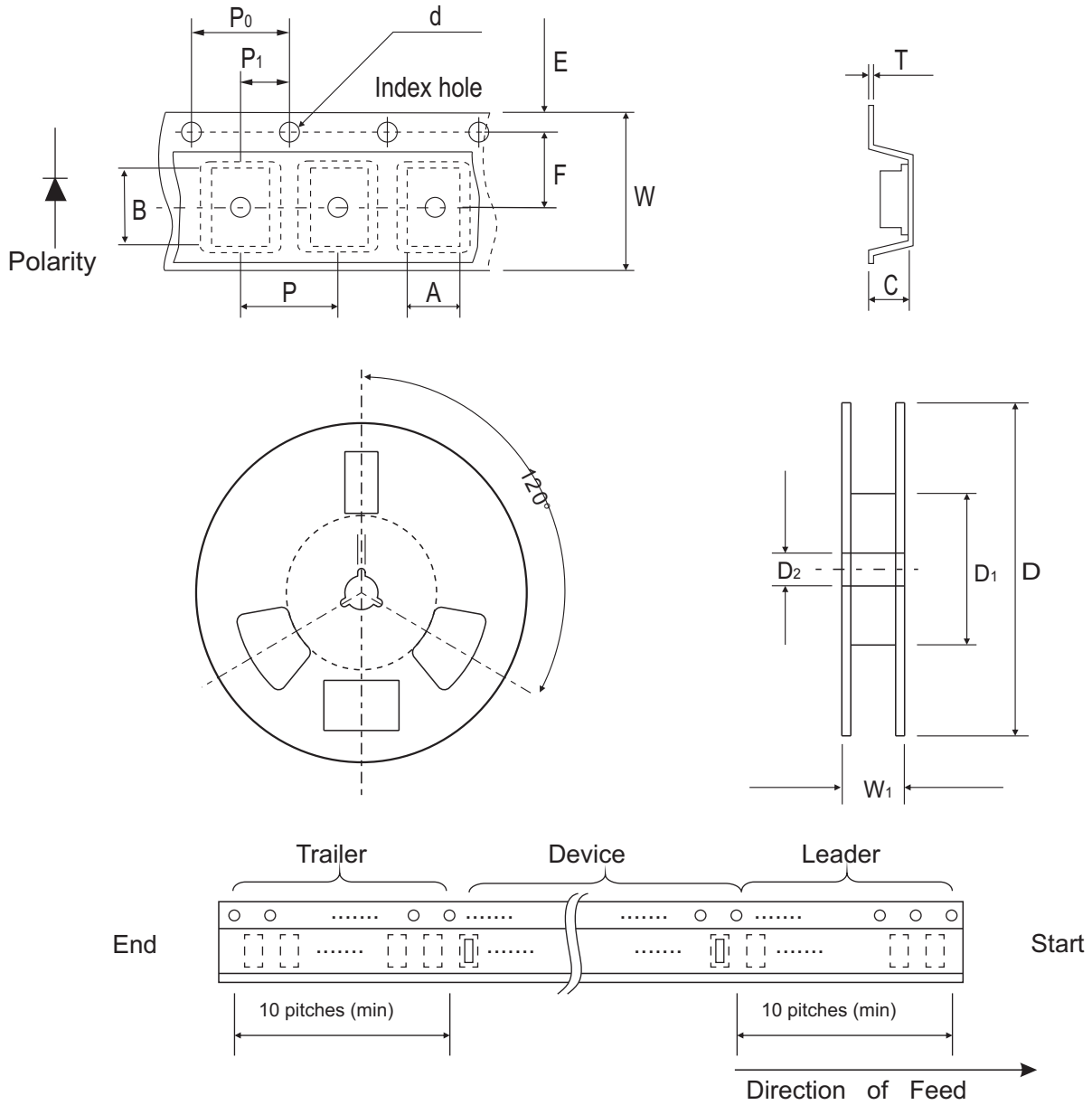

Fig. 5 - Capacitance between terminals characteristics



## Reel Taping Specification



0402 (SOD-923F)	SYMBOL	A	B	C	d	D	D <sub>1</sub>	D <sub>2</sub>
	(mm)	0.75 ± 0.10	1.15 ± 0.10	0.60 ± 0.10	1.55 ± 0.10	178 ± 1	60.0 MIN.	13.0 ± 0.20
	(inch)	0.030 ± 0.004	0.045 ± 0.004	0.024 ± 0.004	0.061 ± 0.004	7.008 ± 0.04	2.362 MIN.	0.512 ± 0.008

0402 (SOD-923F)	SYMBOL	E	F	P	P <sub>0</sub>	P <sub>1</sub>	T	W	W <sub>1</sub>
	(mm)	1.75 ± 0.10	3.50 ± 0.05	4.00 ± 0.10	4.00 ± 0.10	2.00 ± 0.10	0.22 ± 0.05	8.00 ± 0.20	13.5 MAX.
	(inch)	0.069 ± 0.004	0.138 ± 0.002	0.157 ± 0.004	0.157 ± 0.004	0.079 ± 0.004	0.009 ± 0.002	0.315 ± 0.008	0.531 MAX.

## Marking Code

Part Number	Marking Code
CPDQR24V0U-HF	E4



## Suggested PAD Layout

SIZE	0402/SOD-923F	
	(mm)	(inch)
A	0.750	0.030
B	0.500	0.020
C	0.700	0.028
D	1.250	0.049
E	0.250	0.010

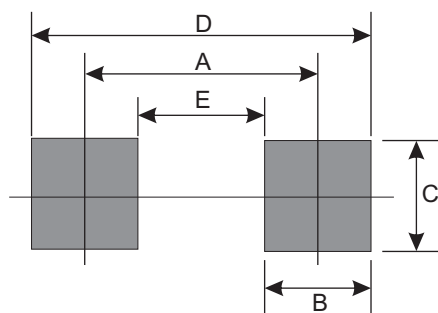

## Standard Packaging

Case Type	Qty per Reel	Reel Size
	(Pcs)	(inch)
0402/SOD-923F	5,000	7