

CPDU5V0C-HF

RoHS Device
Halogen Free

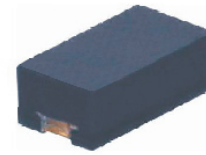

Features

- Bi-directional ESD protection.
- Surface mount package.
- Operating voltage: 5V.

Mechanical data

- Case: 0603/SOD-523F standard package, molded plastic.
- Terminals: Gold plated, solderable per MIL-STD-750, method 2026.
- Marking Code:
CPDU5V0C-HF: E05
- Mounting position: Any.
- Weight: 0.003 gram(approx.).

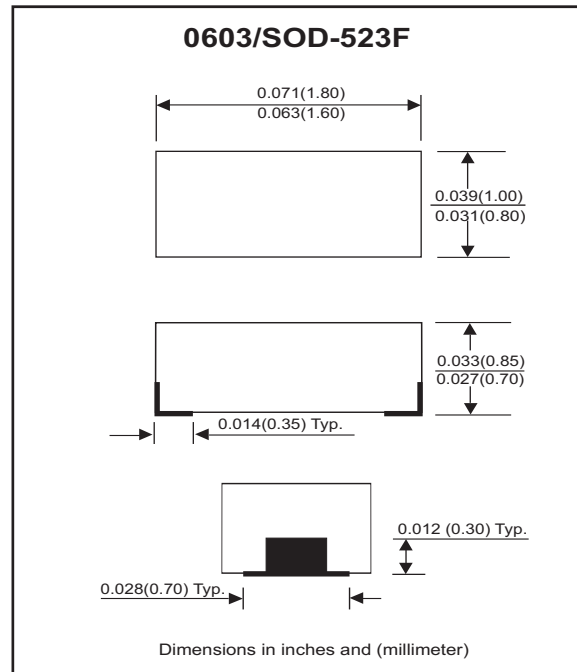

Electrical Characteristics (at TA=25 °C unless otherwise noted)

Parameter	Conditions	Symbol	Min	Typ	Max	Unit
Diode breakdown voltage	$I_R = 1\text{mA}$	V_{BD}	6.1	7		V
Leakage current	$V_R = 5\text{V}$	I_L		0.1	2	μA
Junction capacitance	$V_R = 0\text{V}, f = 1\text{MHz}$	C_T		25	30	pF
ESD capability	IEC 61000-4-2(air)	ESD			16	kV
	IEC 61000-4-2(contact)				8	
Clamping Voltage	$I_{PP} = 1\text{A}, t_p = 8/20\mu\text{s}$	V_c			9	V
	$I_{PP} = 4\text{A}, t_p = 8/20\mu\text{s}$	V_c			14.5	V
Operation temperature		T_j			125	$^{\circ}\text{C}$
Storage temperature		T_{STG}	-55		150	$^{\circ}\text{C}$

RATING AND CHARACTERISTIC CURVES (CPDU5V0C-HF)

Fig. 1 - Reverse characteristics

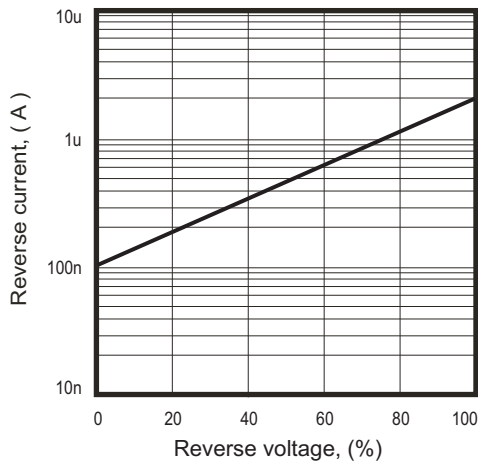

Fig. 2 - Capacitance between terminals characteristics

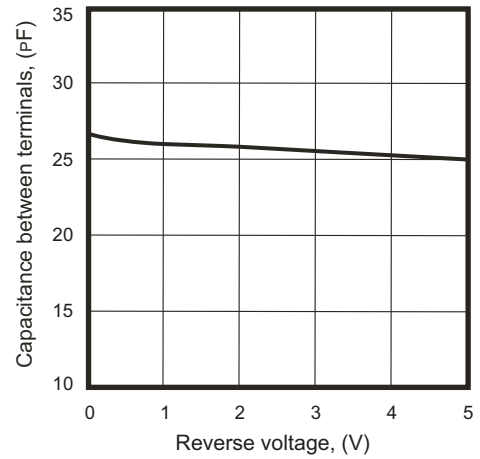

Fig.3 - Clamping voltage vs. peak pulse current

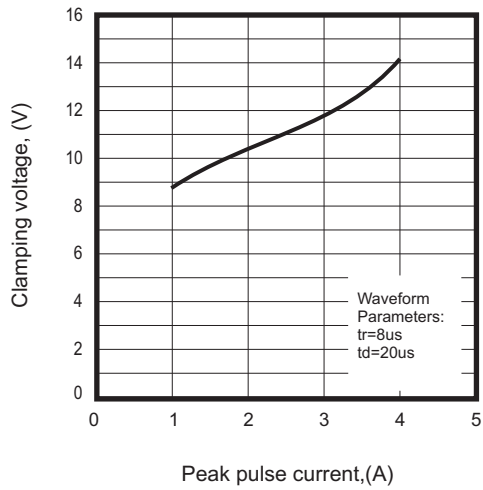
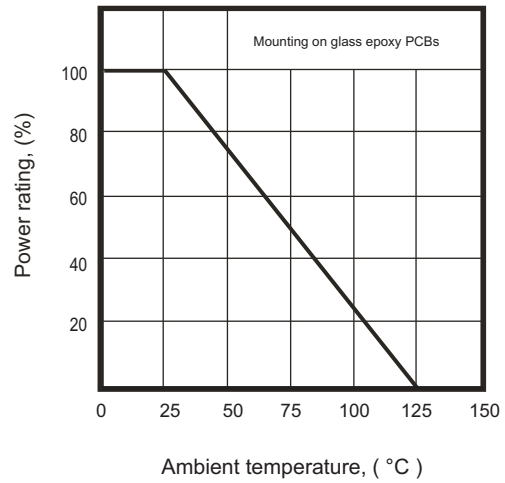
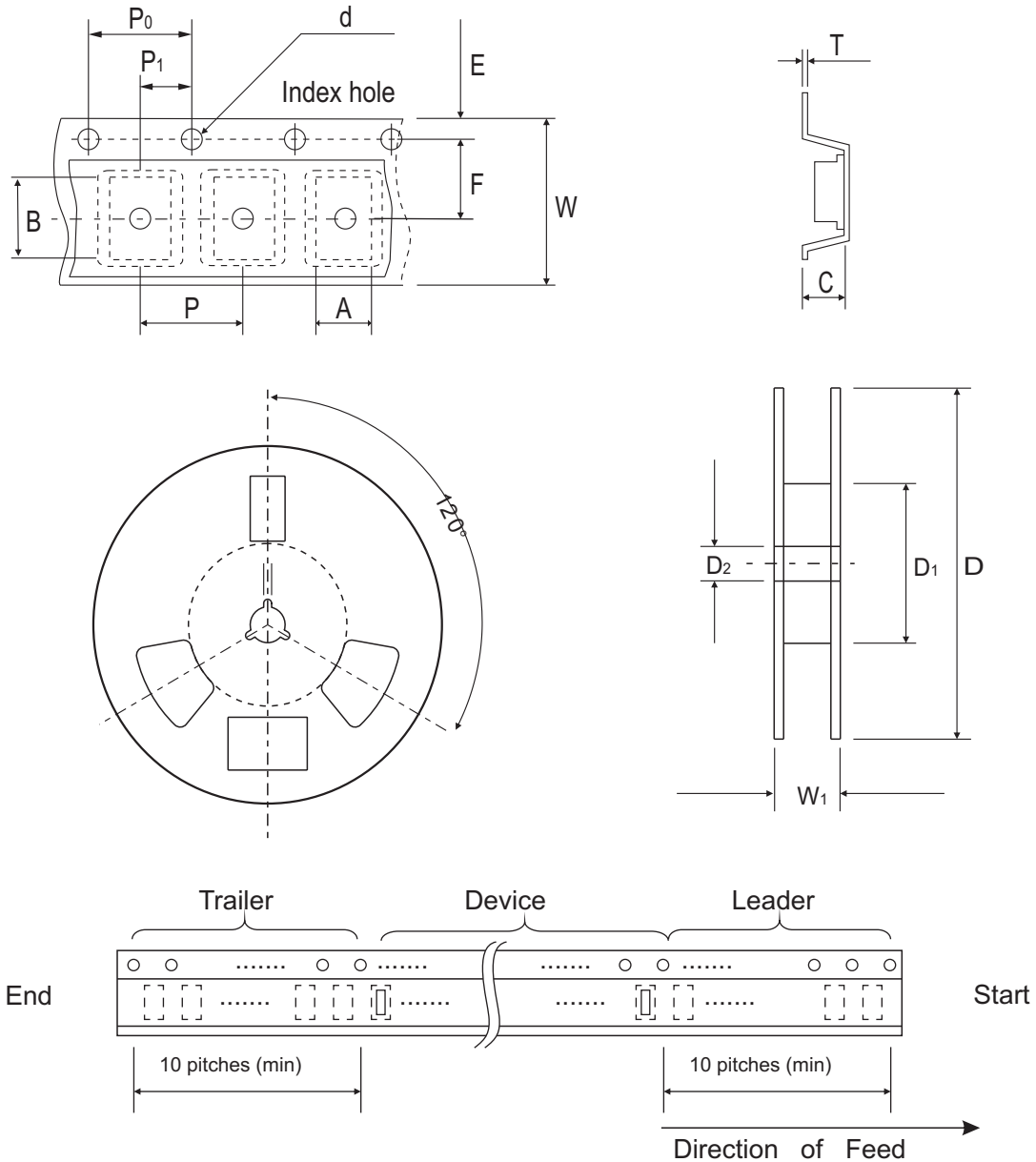

Fig. 4 - Power rating derating curve



Reel Taping Specification



0603 (SOD-523)	SYMBOL	A	B	C	d	D	D ₁	D ₂
	(mm)	1.00 ± 0.10	1.85 ± 0.10	1.00 ± 0.10	1.55 ± 0.05	178 ± 1	60.0 MIN.	13.0 ± 0.20
	(inch)	0.039 ± 0.004	0.073 ± 0.004	0.039 ± 0.004	0.061 ± 0.002	7.008 ± 0.04	2.362 MIN.	0.512 ± 0.008

0603 (SOD-523)	SYMBOL	E	F	P	P ₀	P ₁	T	W	W ₁
	(mm)	1.75 ± 0.10	3.50 ± 0.05	4.00 ± 0.10	4.00 ± 0.10	2.00 ± 0.05	0.23 ± 0.05	8.00 ± 0.20	13.5 MAX.
	(inch)	0.069 ± 0.004	0.138 ± 0.002	0.157 ± 0.004	0.157 ± 0.004	0.079 ± 0.004	0.009 ± 0.002	0.315 ± 0.008	0.531 MAX.

Marking Code

Part Number	Marking Code
CPDU5V0C-HF	E05



Suggested PAD Layout

SIZE	0603/SOD-523F	
	(mm)	(inch)
A	1.70	0.067
B	0.60	0.024
C	0.80	0.031
D	2.30	0.091
E	1.10	0.043

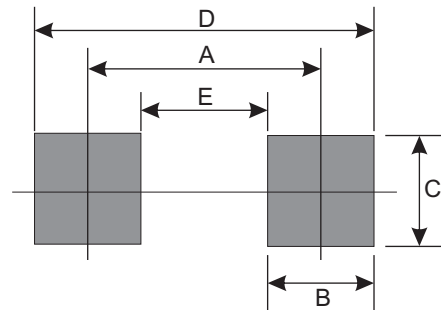

Standard Packaging

Case Type	Qty Per Reel	Reel Size
	(Pcs)	(inch)
0603/SOD-523F	4,000	7