

## MP10005G-G Thru. MP1010G-G

Reverse Voltage: 50 to 1000V

Forward Current: 10.0A

RoHS Device

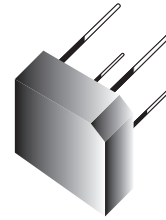

### Features

- Low forward voltage drop.
- Small size ; simple installation.
- Sliver plated copper leads
- Surge overload rating - 200 amperes peak.
- Materials used carries U/L recognition.

### Mechanical Data

- Polarit:As marked on Body
- Mounting position:Any
- Weight: 7.33 grams

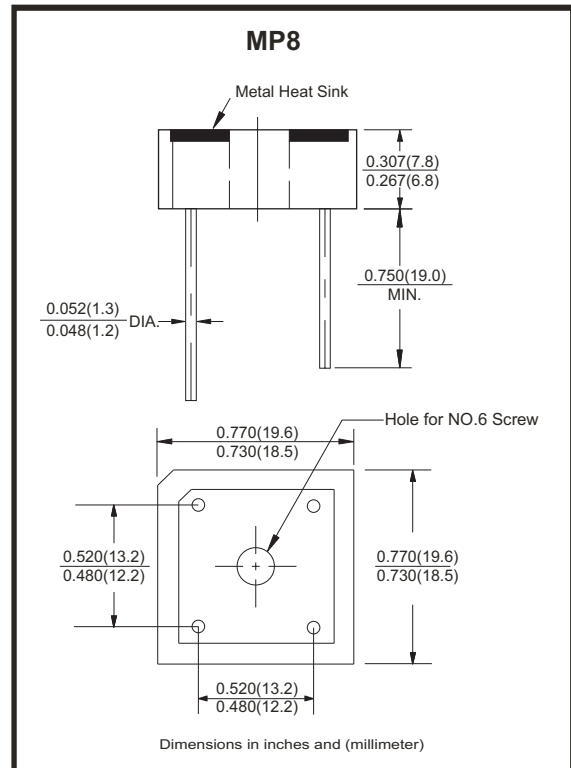

### Maximum ratings and electrical characteristics

Rating at 25°C ambient temperature unless otherwise specified.  
Single phase, half wave ,60Hz, resistive or inductive load.  
For capacitive load, derate current by 20%

Parameter	Symbol	MP10005G-G	MP1001G-G	MP1002G-G	MP1004G-G	MP1006G-G	MP1008G-G	MP1010G-G	Unit
Maximum Peak Recurrent Reverse Voltage	$V_{RRM}$	50	100	200	400	600	800	1000	V
Maximum RMS Bridge Input Voltage	$V_{RMS}$	35	70	140	280	420	560	700	V
Maximum DC Blocking Voltage	$V_{DC}$	50	100	200	400	600	800	1000	V
Maximum Average Forward Rectified Output Current @ $T_A=50^{\circ}C$	$I_{(AV)}$	10.0							A
Peak Forward Surage Current , 8.3ms Single Half Sine-Wave Super Imposed On Rated Load	$I_{FSM}$	175							A
Maximum Forward Voltage Drop Per Bridge Element at 5.0A Peak	$V_F$	1.1							V
Maximum Reverse Current at Rated DC Blocking Voltage Per Element	@ $T_J=25^{\circ}C$	10							$\mu A$
	@ $T_J=100^{\circ}C$	1.0							mA
Operating Temperature Range	$T_J$	-55 to +150							$^{\circ}C$
Storage Temperature Range	$T_{STG}$	-55 to +150							$^{\circ}C$

## Rating and Characteristics Curves (MP10005G-G Thru. MP1010G-G)

Fig.1 - Derating Curve Output Rectified Current

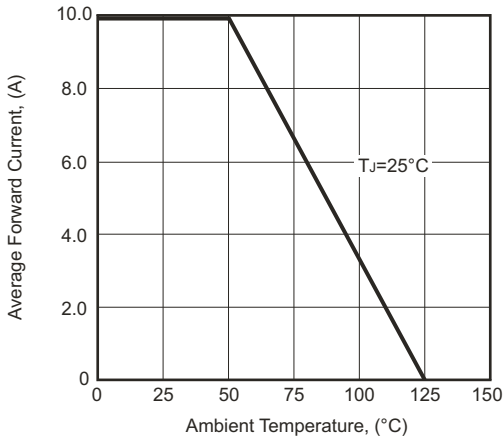

Fig.2 - Maximum Forward Surge Current

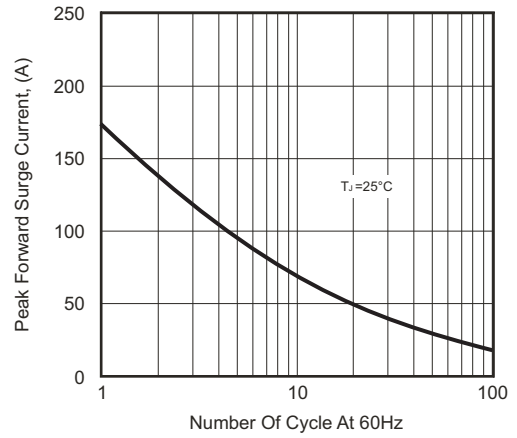

Fig.3 - Typical Forward Characteristics

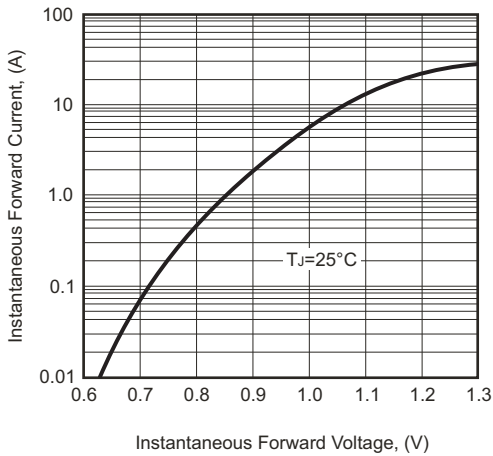
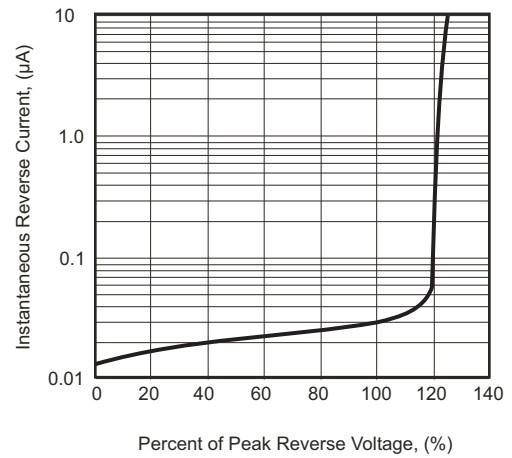
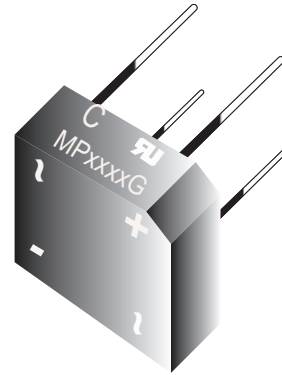

Fig.4 - Typical Reverse Characteristics



## Marking Code

Part Number	Marking code
MP10005G-G	MP10005G
MP1001G-G	MP1001G
MP1002G-G	MP1002G
MP1004G-G	MP1004G
MP1006G-G	MP1006G
MP1008G-G	MP1008G
MP1010G-G	MP1010G



XXXX / XXXXX = Product type marking code  
 C = Comchip Logo

## Standard Packaging

Case Type	BULK PACK	
	BOX ( pcs )	CARTON ( pcs )
MP8	200	2,000