

SMD Transient Voltage Suppressor

TV15C5V0-HF Thru. TV15C441-HF

Working Peak Reverse Voltage: 5.0 - 440 Volts

Power Dissipation: 1500Watts

RoHS Device

Halogen Free

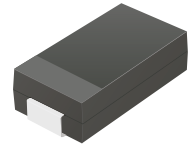

Features

- Glass passivated chip.
- 1500 W peak pulse power capability with a 10/1000 μ s waveform, repetitive rate (duty cycle):0.01%
- Low leakage
- Uni and Bidirectional unit
- Excellent clamping capability.
- Very fast response time

Mechanical Data

- Case: DO-214AB/SMC molded plastic.
- Epoxy: UL 94V-0 rate flame retardant
- Terminals: solderable per MIL-STD-750, method 2026.
- Polarity: Cathode band denoted.
- Weight: Approx. 0.21 grams.

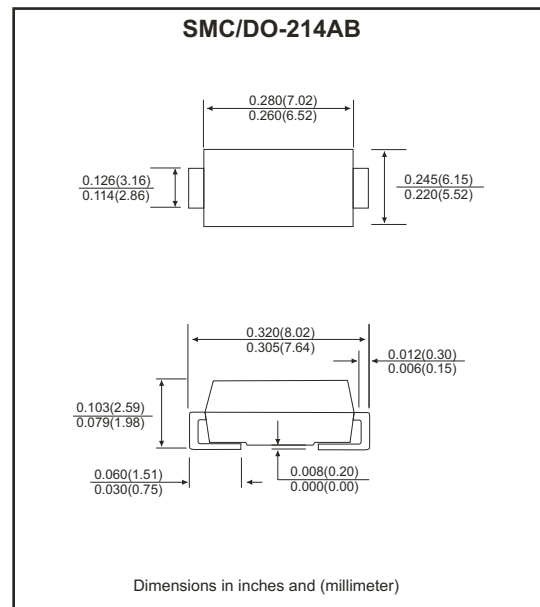

Maximum Ratings and Electrical Characteristics

Rating at 25°C ambient temperature unless otherwise specified.

Single phase, half wave, 60Hz, resistive or inductive load.

For capacitive load, derate current by 20%.

Characteristics	Symbol	Value	Units
Peak power dissipation at 10/1000 μ s waveform (Notes.1)	P _{PPM}	1500	W
Peak pulse current at 10/1000 μ s waveform (Notes.1)	I _{PPM}	See table 1	A
Steady state power dissipation at T _L =75°C	P _D	6.5	W
Peak forward surge current, 8.3ms single half sine-wave superimposed on rated load, uni-directional only (Notes.2)	I _{FSM}	200	A
Maximum instantaneous forward voltage at 100A for uni-directional only (Note.3)	V _F	3.5/5.0	V
Operation junction temperature range	T _J	-55 to +150	°C
Storage temperature range	T _{STG}	-55 to +150	°C

Notes:

1. Non-repetitive current pulse, per Fig. 5 and derated above T_A=25 °C, per Fig. 1
2. Measured on 8.3 ms single half sine-wave or equivalent square wave, duty cycle=4 pulses per minute maximum.
3. V_F<3.5V for devices of V_{BR}<200V and V_F<5.0V for devices of V_{BR}>201V

Ratings and Characteristics Curve (TV15C5V0-HF Thru. TV15C441-HF)

Fig.1 Pulse Derating Curve

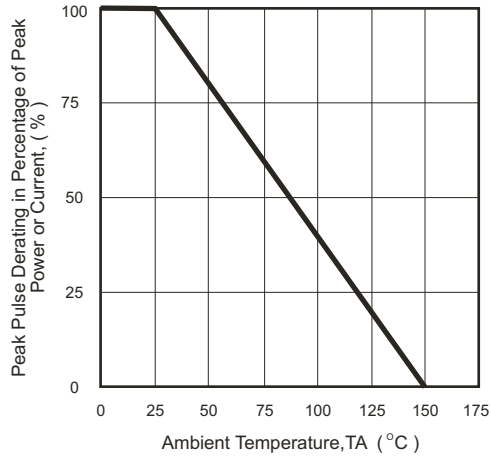

Fig.2 Max. Non-Repetitive Surge Current

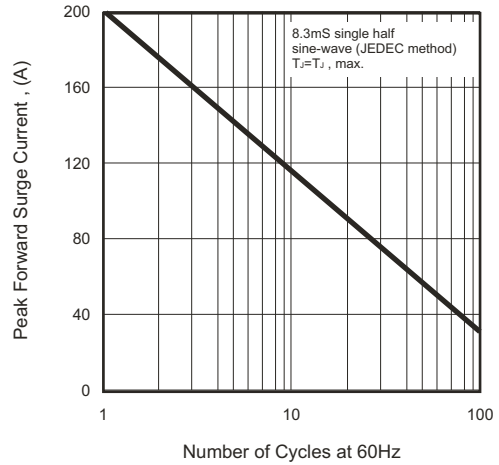

Fig.3 Steady State Power Derating Curve

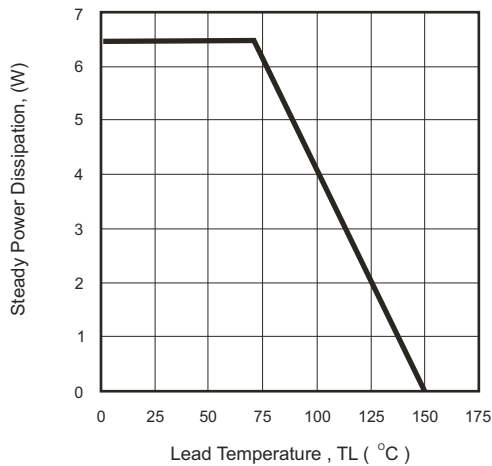

Fig.4 Peak Pulse Power Rating Curve

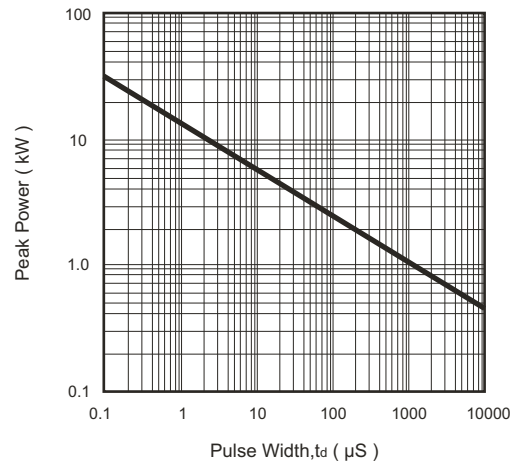

Fig.5 Pulse Waveform

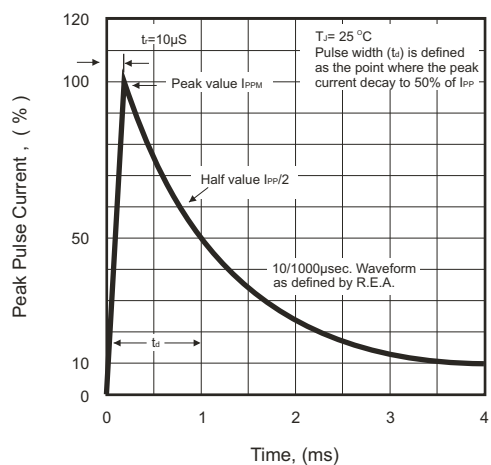
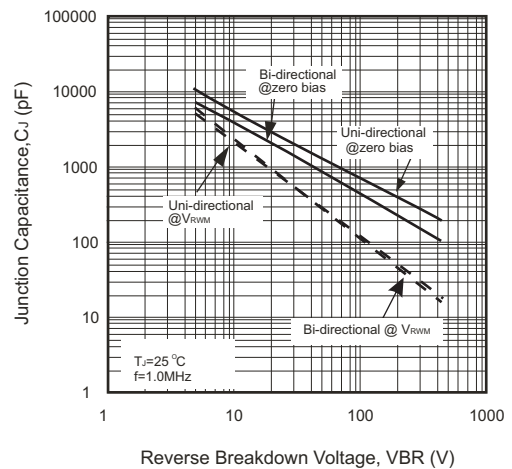

Fig.6 Typical Junction Capacitance



SMD Transient Voltage Suppressor

Electrical Characteristics (TV15C5V0-HF Thru. TV15C441-HF)

Part No	Absolute Maximum Rating(Ta=25° C)					Electrical Characteristic(Ta=25° C)				
	V _{RWM}	V _{BR} Min	V _{BR} Max	I _T	I _{FSM}	MAX V _C	I _R @V _{RWM}	Marking Code		
	(V)	(V)	(V)	(mA)	(A)@8.3ms	(V)	IPP(A)	(μ A)	UNI	BI
TV15C5V0K(B)-HF	5.00	6.40	7.30	10	200	9.6	156.25	1000	GDD	BDD
TV15C5V0J(B)-HF	5.00	6.40	7.00	10	200	9.2	163.04	1000	GDE	BDE
TV15C6V0K(B)-HF	6.00	6.67	8.15	10	200	11.4	131.58	1000	GDF	BDF
TV15C6V0J(B)-HF	6.00	6.67	7.37	10	200	10.3	145.63	1000	GDG	BDG
TV15C6V5K(B)-HF	6.50	7.22	8.82	10	200	12.3	121.95	500	GDH	BDH
TV15C6V5J(B)-HF	6.50	7.22	7.98	10	200	11.2	133.93	500	GDK	BDK
TV15C7V0K(B)-HF	7.00	7.78	9.51	10	200	13.3	112.78	200	GDL	BDL
TV15C7V0J(B)-HF	7.00	7.78	8.60	10	200	12.0	125.00	200	GDM	BDM
TV15C7V5K(B)-HF	7.50	8.33	10.20	1	200	14.3	104.90	100	GDN	BDN
TV15C7V5J(B)-HF	7.50	8.33	9.21	1	200	12.9	116.28	100	GDP	BDP
TV15C8V0K(B)-HF	8.00	8.89	10.90	1	200	15.0	100.00	50	GDQ	BDQ
TV15C8V0J(B)-HF	8.00	8.89	9.83	1	200	13.6	110.29	50	GDR	BDR
TV15C8V5K(B)-HF	8.50	9.44	11.50	1	200	15.9	94.34	20	GDS	BDS
TV15C8V5J(B)-HF	8.50	9.44	10.40	1	200	14.4	104.17	20	GDT	BDT
TV15C9V0K(B)-HF	9.00	10.00	12.20	1	200	16.9	88.76	10	GDU	BDU
TV15C9V0J(B)-HF	9.00	10.00	11.10	1	200	15.4	97.40	10	GDV	BDV
TV15C100K(B)-HF	10.0	11.10	13.60	1	200	18.8	79.79	5	GDW	BDW
TV15C100J(B)-HF	10.0	11.10	12.30	1	200	17.0	88.24	5	GDX	BDX
TV15C110K(B)-HF	11.0	12.20	14.90	1	200	20.1	74.63	5	GDY	BDY
TV15C110J(B)-HF	11.0	12.20	13.50	1	200	18.2	82.42	5	GDZ	BDZ
TV15C120K(B)-HF	12.0	13.30	16.30	1	200	22.0	68.18	5	GED	BED
TV15C120J(B)-HF	12.0	13.30	14.70	1	200	19.9	75.38	5	GEE	BEE
TV15C130K(B)-HF	13.0	14.40	17.60	1	200	23.8	63.03	5	GEF	BEF
TV15C130J(B)-HF	13.0	14.40	15.90	1	200	21.5	69.77	5	GDG	BEG
TV15C140K(B)-HF	14.0	15.60	19.10	1	200	25.8	58.14	5	GEH	BEH
TV15C140J(B)-HF	14.0	15.60	17.20	1	200	23.2	64.66	5	GEK	BEK
TV15C150K(B)-HF	15.0	16.70	20.40	1	200	26.9	55.76	5	GEL	BEL
TV15C150J(B)-HF	15.0	16.70	18.50	1	200	24.4	61.48	5	GEM	BEM
TV15C160K(B)-HF	16.0	17.80	21.80	1	200	28.8	52.08	5	GEN	BEN
TV15C160J(B)-HF	16.0	17.80	19.70	1	200	26.0	57.69	5	GEP	BEP
TV15C170K(B)-HF	17.0	18.90	23.10	1	200	30.5	49.18	5	GEQ	BEQ
TV15C170J(B)-HF	17.0	18.90	20.90	1	200	27.6	54.35	5	GER	BER
TV15C180K(B)-HF	18.0	20.00	24.40	1	200	32.2	46.58	5	GES	BES
TV15C180J(B)-HF	18.0	20.00	22.10	1	200	29.2	51.37	5	GET	BET
TV15C190K(B)-HF	19.0	21.13	25.76	1	200	34.0	44.10	5	GEA	BEA
TV15C190J(B)-HF	19.0	21.10	23.30	1	200	30.8	48.73	5	GEB	BEB
TV15C200K(B)-HF	20.0	22.20	27.10	1	200	35.8	41.90	5	GEU	BEU
TV15C200J(B)-HF	20.0	22.20	24.50	1	200	32.4	46.30	5	GEV	BEV
TV15C220K(B)-HF	22.0	24.40	29.80	1	200	39.4	38.07	5	GEW	BEW
TV15C220J(B)-HF	22.0	24.40	26.90	1	200	35.5	42.25	5	GEX	BEX
TV15C240K(B)-HF	24.0	26.70	32.60	1	200	43.0	34.88	5	GEY	BEY
TV15C240J(B)-HF	24.0	26.70	29.50	1	200	38.9	38.56	5	GEZ	BEZ
TV15C260K(B)-HF	26.0	28.90	35.30	1	200	46.6	32.19	5	GFD	BFD
TV15C260J(B)-HF	26.0	28.90	31.90	1	200	42.1	35.63	5	GFE	BFE
TV15C280K(B)-HF	28.0	31.10	38.00	1	200	50.0	30.00	5	GFF	BFF
TV15C280J(B)-HF	28.0	31.10	34.40	1	200	45.4	33.04	5	GFG	BFG
TV15C300K(B)-HF	30.0	33.30	40.70	1	200	53.5	28.04	5	GFH	BFH
TV15C300J(B)-HF	30.0	33.30	36.80	1	200	48.4	30.99	5	GFK	BFK

SMD Transient Voltage Suppressor

Electrical Characteristics (TV15C5V0-HF Thru. TV15C441-HF)

Part No	Absolute Maximum Rating(Ta=25 °C)					Electrical Characteristic(Ta=25 °C)				
	V _{RWM}	V _{BR} Min	V _{BR} Max	I _T	I _{FSM}	MAX V _C	I _R @V _{RWM}	Marking Code		
	(V)	(V)	(V)	(mA)	(A)@8.3ms	(V)	IPP(A)	(uA)	UNI	BI
TV15C330K(B)-HF	33.0	36.70	44.90	1	200	59.0	25.42	5	GFL	BFL
TV15C330J(B)-HF	33.0	36.70	40.60	1	200	53.3	28.14	5	GFM	BFM
TV15C360K(B)-HF	36.0	40.00	48.90	1	200	64.3	23.33	5	GFN	BFN
TV15C360J(B)-HF	36.0	40.00	44.20	1	200	58.1	25.82	5	GFP	BFP
TV15C400K(B)-HF	40.0	44.40	54.30	1	200	71.4	21.01	5	GFQ	BFQ
TV15C400J(B)-HF	40.0	44.40	49.10	1	200	64.5	23.26	5	GFR	BFR
TV15C430K(B)-HF	43.0	47.80	58.40	1	200	76.7	19.56	5	GFS	BFS
TV15C430J(B)-HF	43.0	47.80	52.80	1	200	69.4	21.61	5	GFT	BFT
TV15C450K(B)-HF	45.0	50.00	61.10	1	200	80.3	18.68	5	GFU	BFU
TV15C450J(B)-HF	45.0	50.00	55.30	1	200	72.7	20.63	5	GFV	BFV
TV15C480K(B)-HF	48.0	53.30	65.10	1	200	85.5	17.54	5	GFW	BFW
TV15C480J(B)-HF	48.0	53.30	58.90	1	200	77.4	19.38	5	GFX	BFX
TV15C510K(B)-HF	51.0	56.70	69.30	1	200	91.1	16.47	5	GFY	BFY
TV15C510J(B)-HF	51.0	56.70	62.70	1	200	82.4	18.20	5	GFZ	BFZ
TV15C540K(B)-HF	54.0	60.00	73.30	1	200	96.3	15.58	5	GGD	BGD
TV15C540J(B)-HF	54.0	60.00	66.30	1	200	87.1	17.22	5	GGE	BGE
TV15C580K(B)-HF	58.0	64.40	78.70	1	200	103.0	14.56	5	GGF	BGF
TV15C580J(B)-HF	58.0	64.40	71.20	1	200	93.6	16.03	5	GGG	BGG
TV15C600K(B)-HF	60.0	66.70	81.50	1	200	107.0	14.02	5	GGH	BGH
TV15C600J(B)-HF	60.0	66.70	73.70	1	200	96.8	15.50	5	GGK	BGK
TV15C640K(B)-HF	64.0	71.10	86.90	1	200	114.0	13.16	5	GGL	BGL
TV15C640J(B)-HF	64.0	71.10	78.60	1	200	103.0	14.56	5	GGM	BGM
TV15C700K(B)-HF	70.0	77.80	95.10	1	200	125.0	12.00	5	GGN	BGN
TV15C700J(B)-HF	70.0	77.80	86.00	1	200	113.0	13.27	5	GGP	BGP
TV15C750K(B)-HF	75.0	83.30	102.00	1	200	134.0	11.19	5	GGQ	BGQ
TV15C750J(B)-HF	75.0	83.30	92.10	1	200	121.0	12.40	5	GGR	BGR
TV15C780K(B)-HF	78.0	86.70	106.00	1	200	139.0	10.79	5	GGS	BGS
TV15C780J(B)-HF	78.0	86.70	95.80	1	200	126.0	11.90	5	GGT	BGT
TV15C800K(B)-HF	80.0	88.96	108.80	1	200	143.2	10.47	5	GGA	BGA
TV15C800J(B)-HF	80.0	88.80	97.60	1	200	129.6	11.57	5	GGB	BGB
TV15C850K(B)-HF	85.0	94.40	115.00	1	200	151.0	9.93	5	GGU	BGU
TV15C850J(B)-HF	85.0	94.40	104.00	1	200	137.0	10.95	5	GGV	BGV
TV15C900K(B)-HF	90.0	100.00	122.00	1	200	160.0	9.38	5	GGW	BGW
TV15C900J(B)-HF	90.0	100.00	111.00	1	200	146.0	10.27	5	GGX	BGX
TV15C101K(B)-HF	100.0	111.00	136.00	1	200	179.0	8.38	5	GGY	BGY
TV15C101J(B)-HF	100.0	111.00	123.00	1	200	162.0	9.26	5	GGZ	BGZ
TV15C111K(B)-HF	110.0	122.00	149.00	1	200	196.0	7.65	5	GHD	BHD
TV15C111J(B)-HF	110.0	122.00	135.00	1	200	177.0	8.47	5	GHE	BHE
TV15C121K(B)-HF	120.0	133.00	163.00	1	200	214.0	7.01	5	GHF	BHF
TV15C121J(B)-HF	120.0	133.00	147.00	1	200	193.0	7.77	5	GHG	BHG
TV15C131K(B)-HF	130.0	144.00	176.00	1	200	231.0	6.49	5	GHH	BHH
TV15C131J(B)-HF	130.0	144.00	159.00	1	200	209.0	7.18	5	GHK	BHK
TV15C141K(B)-HF	140.0	155.68	190.40	1	200	250.6	5.99	5	GHA	BHA
TV15C141J(B)-HF	140.0	155.00	171.00	1	200	226.8	6.61	5	GHB	BHB
TV15C151K(B)-HF	150.0	167.00	204.00	1	200	268.0	5.60	5	GHL	BHL
TV15C151J(B)-HF	150.0	167.00	185.00	1	200	243.0	6.17	5	GHM	BHM

SMD Transient Voltage Suppressor



Electrical Characteristics (TV15C5V0-HF Thru. TV15C441-HF)

Part No.	Absolute Maximum Rating (T _A =25 °C)					Electrical Characteristic (T _A =25 °C)				
	V _{RWM}	V _{BR} Min.	V _{BR} Max.	I _T	I _{FSM}	Max V _C		I _R @V _{RWM}	Marking Code	
	(V)	(V)	(V)	(mA)	(A)@8.3mS	(V)	I _{PP} (A)	(uA)	UNI	BI
TV15C161K(B)-HF	160.0	178.00	218.00	1	200	287.0	5.23	5	GHN	BHN
TV15C161J(B)-HF	160.0	178.00	197.00	1	200	259.0	5.79	5	GHP	BHP
TV15C171K(B)-HF	170.0	189.00	231.00	1	200	304.0	4.93	5	GHQ	BHQ
TV15C171J(B)-HF	170.0	189.00	209.00	1	200	275.0	5.45	5	GHR	BHR
TV15C181K(B)-HF	180.0	200.16	244.80	1	200	322.2	4.66	5	GHS	BHS
TV15C181J(B)-HF	180.0	200.00	220.00	1	200	291.6	5.14	5	GHT	BHT
TV15C191K(B)-HF	190.0	211.28	258.40	1	200	340.1	4.41	5	GHU	BHU
TV15C191J(B)-HF	190.0	211.00	232.00	1	200	307.8	4.87	5	GHV	BHV
TV15C201J(B)-HF	200.0	224.00	247.00	1	200	324.0	4.60	5	GHW	BHW
TV15C221J(B)-HF	220.0	246.00	272.00	1	200	356.0	4.20	5	GHX	BHX
TV15C251J(B)-HF	250.0	279.00	309.00	1	200	405.0	3.70	5	GHZ	BHZ
TV15C301J(B)-HF	300.0	335.00	371.00	1	200	486.0	3.10	5	GJE	BJE
TV15C351J(B)-HF	350.0	391.00	432.00	1	200	567.0	2.60	5	GJG	BJG
TV15C401J(B)-HF	400.0	447.00	494.00	1	200	648.0	2.30	5	GJK	BJK
TV15C441J(B)-HF	440.0	492.00	543.00	1	200	713.0	2.10	5	GJM	BJM

Note:

- 1) Suffix K denotes 10% tolerance devices, suffix J denotes 5% tolerance devices.
- 2) Suffix B after part number to specify Bi-directional devices.
- 3) For Bi-Directional devices having V_R of 10 volts and under, the I_R limit is double.

Reel Taping Specification

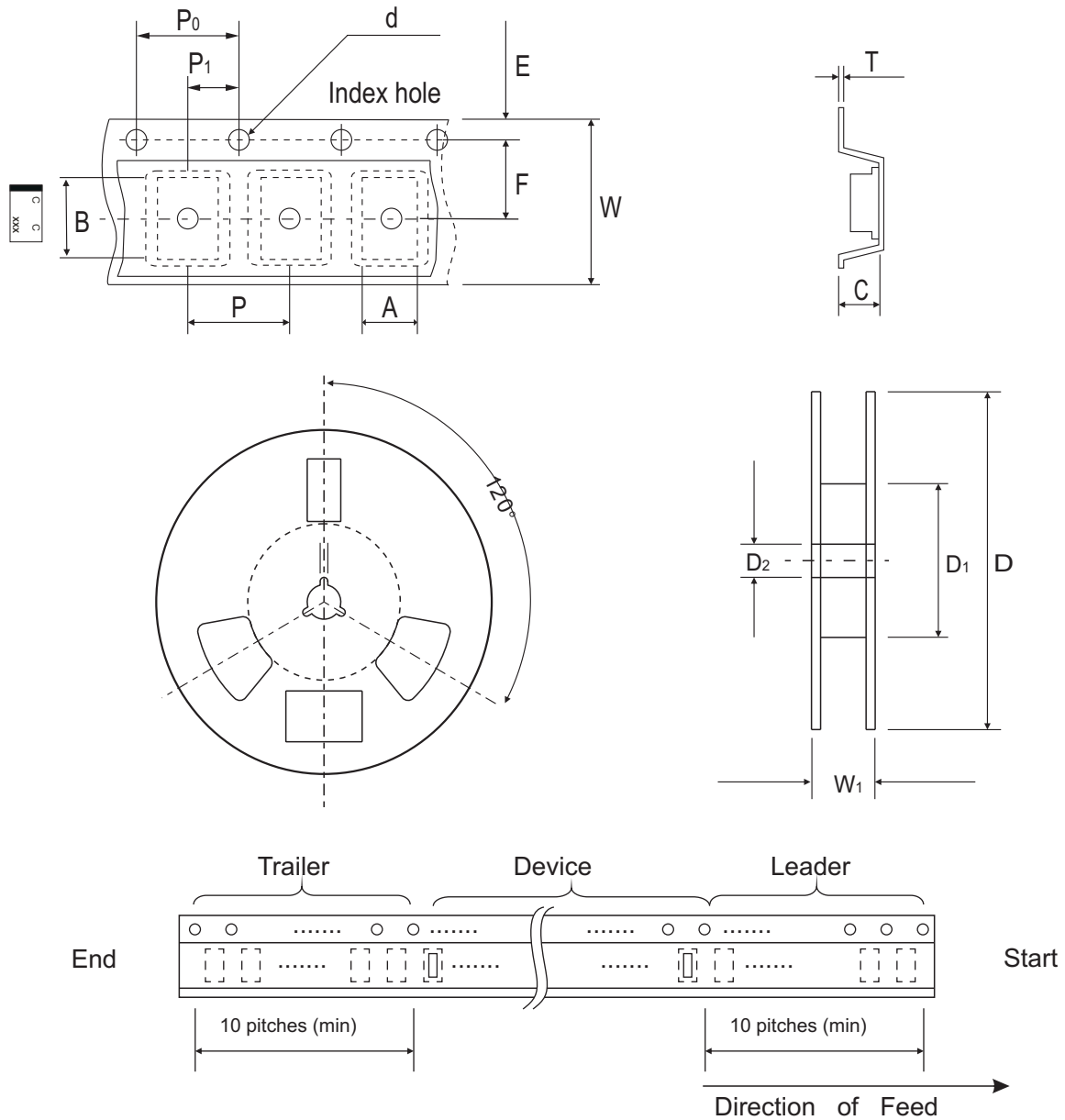

DO-214AB (SMC)	SYMBOL	A	B	C	d	D	D1	D2
	(mm)	6.05 ± 0.10	8.31 ± 0.10	3.29 (max)	1.55 ± 0.10-0.0	330	50.0 MIN.	13.0 ± 0.20
	(inch)	0.256 ± 0.004	0.327 ± 0.004	0.130 (max)	0.061 ± 0.004	13.00	1.969 MIN.	0.512 ± 0.008

DO-214AB (SMC)	SYMBOL	E	F	P	P0	P1	W	W1
	(mm)	1.75 ± 0.10	7.50 ± 0.10	8.00 ± 0.10	4.00 ± 0.10	2.00 ± 1.00	16.0 ± 0.30	22.4 MAX.
	(inch)	0.069 ± 0.004	0.295 ± 0.004	0.315 ± 0.004	0.157 ± 0.004	0.079 ± 0.040	0.630 ± 0.012	0.882 MAX.

Marking Code

1. C: COMCHIP
2. O: Package

○	PKG
A	SMA
B	SMB
C	SMC

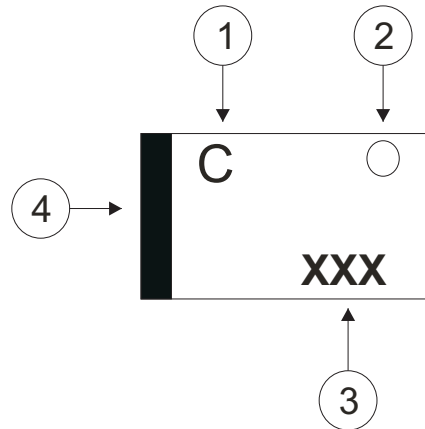

3. XXX: Marking code(see Page.3~5)
4. █: Cathod Band

Suggested PAD Layout

SIZE	DO-214AB(SMC)	
	(mm)	(inch)
A	6.20	0.244
B	1.60	0.063
C	4.80	0.189
D	7.80	0.307
E	4.60	0.181

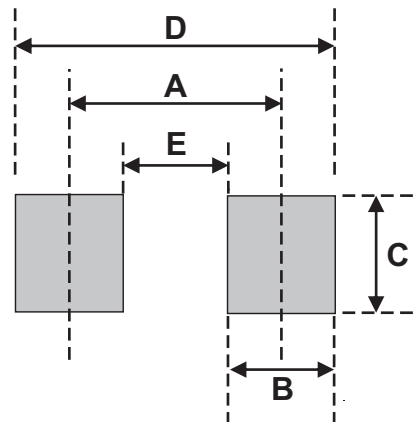

Standard Packaging

Case Type	Qty per Reel	Reel Size
	(Pcs)	(inch)
DO-214AB (SMC)	3000	13