

CDBZ5T30100-HF

Reverse Voltage: 100 Volts

Forward Current: 30 Amp

RoHS Device

Halogen free

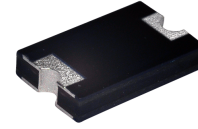

Features

- Lead less chip form, no lead damage.
- Low power loss, High efficiency.
- High current capability, low VF.
- Plastic package has Underwriters Laboratory Flammability Classification 94V-0 .

Mechanical data

- Case: Packed with FRP substrate and epoxy underfilled.
- Terminals: Pure Tin plated (Lead-Free), solderable per MIL-STD-750, method 2026.
- Weight: 0.14 grams (approx).

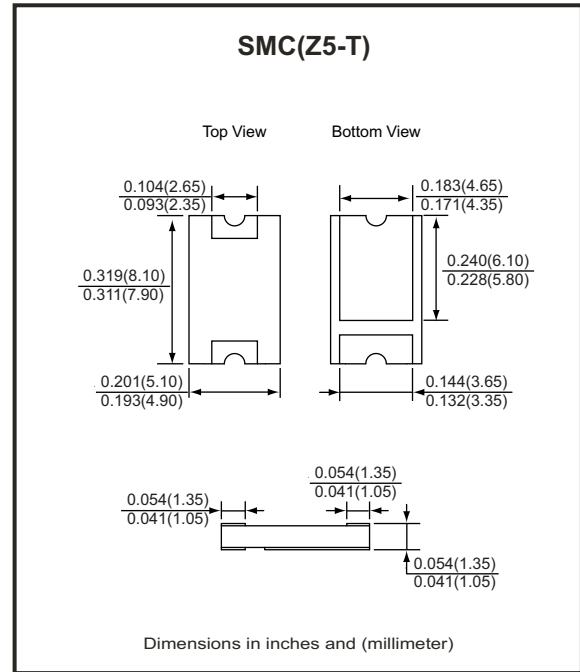

Circuit Diagram



Maximum Ratings (at TA=25°C unless otherwise noted)

Parameter	Symbol	Rating	Unit
Repetitive peak reverse voltage	VRRM	100	V
Average forward current	IF(AV)	30	A
Peak forward surge current (8.3ms single half sine-wave)	IFSM	350	A
Operating and storage temperature range	TJ, TSTG	-55 to +150	°C

Electrical Characteristics (at TA=25°C unless otherwise noted)

Parameter	Symbol	Conditions	Min.	Typ.	Max.	Unit
Forward voltage (NOTE 1)	VF	@ IF = 20 A @ IF = 30 A	-	0.76 0.82	0.80 0.85	V
Repetitive peak reverse current	IRRM	@ VR = Max. VRRM, TA= 25°C	-	3	50	uA
Thermal resistance	RθJA	Junction to ambient (NOTE)	-	78	-	°C/W
	RθJC	Junction to case (NOTE)	-	13	-	°C/W

NOTES : (1) Pulse test width PW=300usec , 1% duty cycle.
(2) Mounted on P.C.B. with 5.0 x 5.0mm copper pad areas.

Company reserves the right to improve product design , functions and reliability without notice.

REV:A

RATING AND CHARACTERISTIC CURVES (CDBZ5T30100-HF)

Fig.1- Forward Current Derating Curve

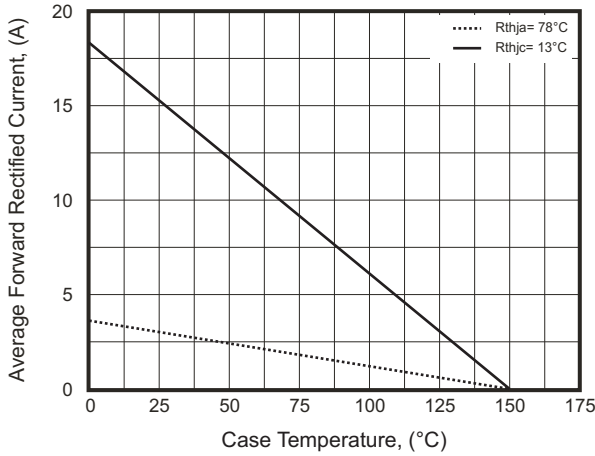

Fig.2- Maximum Non-Repetitive Peak Forward Surge Current

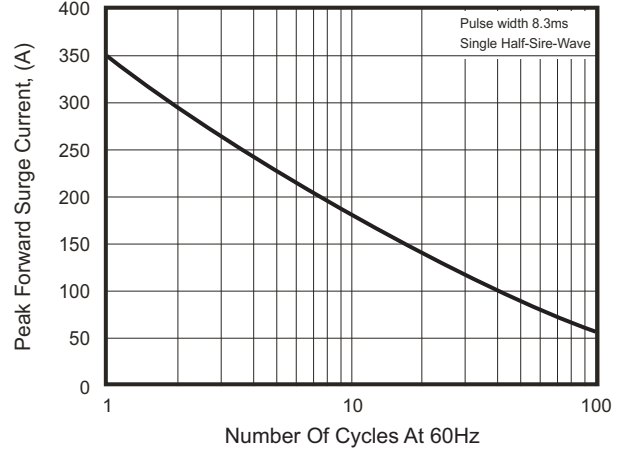

Fig.3- Typical Instantaneous Forward Characteristics

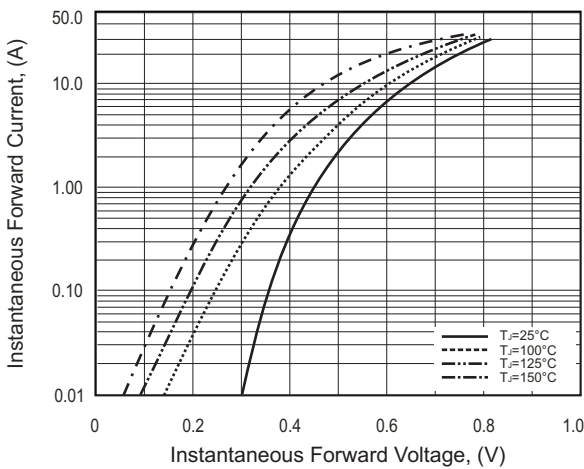
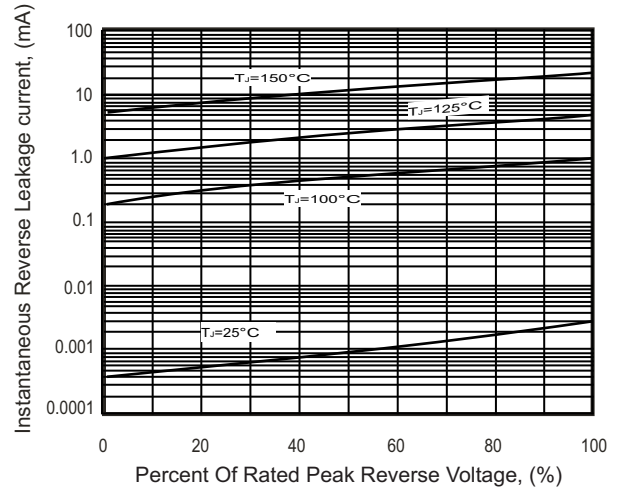
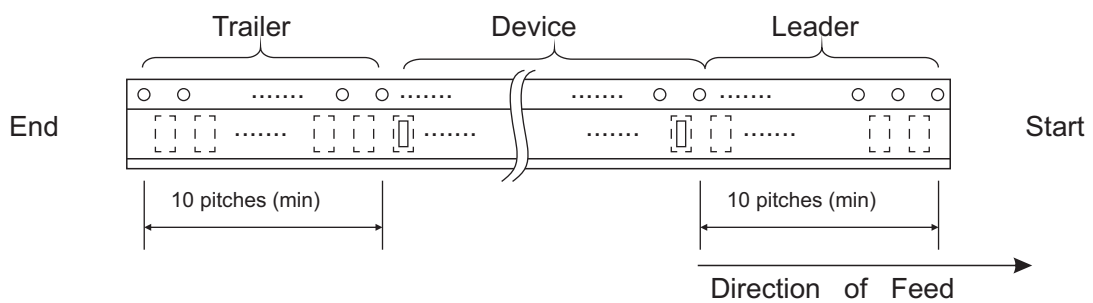
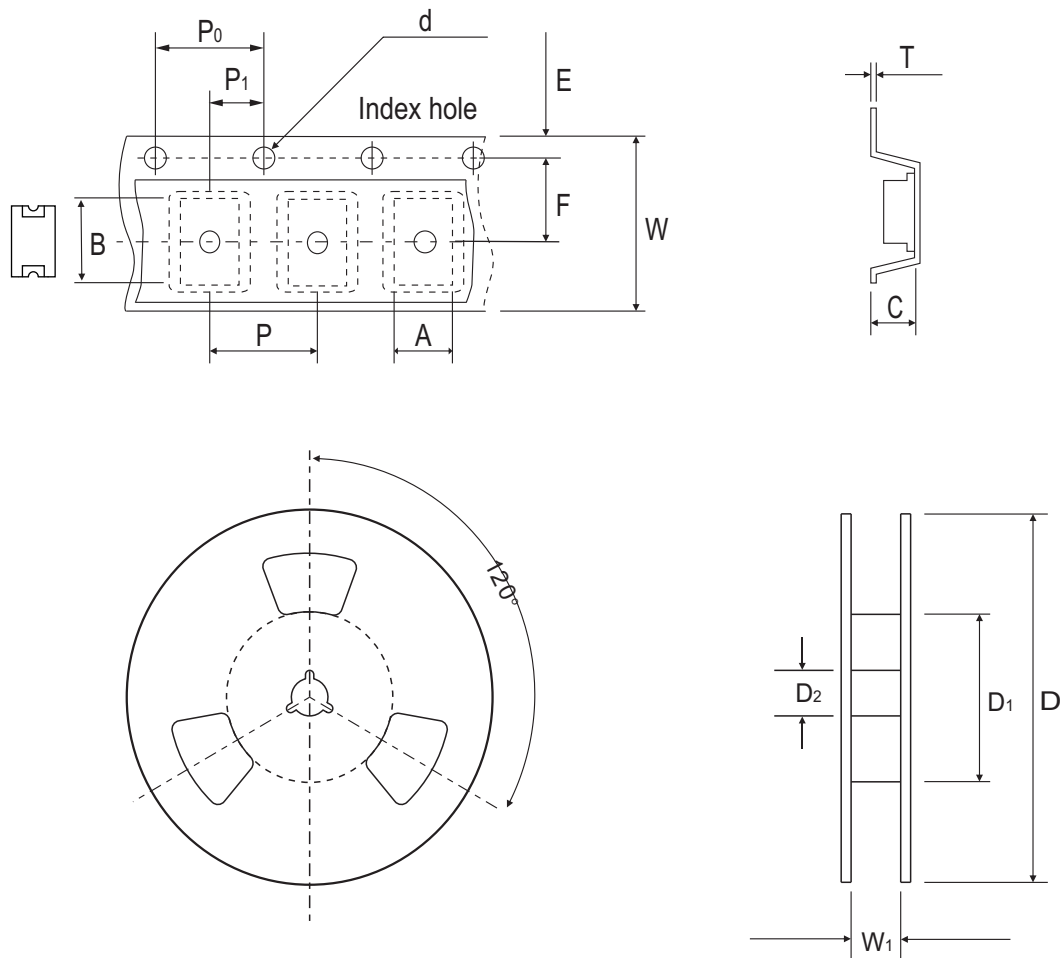

Fig.4- Typical Reverse Characteristics



Company reserves the right to improve product design, functions and reliability without notice.

Reel Taping Specification



SMC(Z5-T)	SYMBOL	A	B	C	d	D	D ₁	D ₂
	(mm)	5.15 ± 0.10	8.15 ± 0.10	1.45 ± 0.10	1.55 ± 0.05	330 ± 2.00	50.0 MIN.	13.0 ± 0.50
	(inch)	0.203 ± 0.004	0.321 ± 0.004	0.057 ± 0.004	0.061 ± 0.002	12.992 ± 0.079	1.969 MIN.	0.512 ± 0.020

SMC(Z5-T)	SYMBOL	E	F	P	P ₀	P ₁	W	W ₁
	(mm)	1.75 ± 0.10	7.50 ± 0.10	8.00 ± 0.10	4.00 ± 0.10	2.00 ± 0.10	16.00 ± 0.30	18.40 MAX.
	(inch)	0.069 ± 0.004	0.295 ± 0.004	0.315 ± 0.004	0.157 ± 0.004	0.079 ± 0.004	0.630 ± 0.012	0.724 MAX.

Marking Code



Suggested PAD Layout

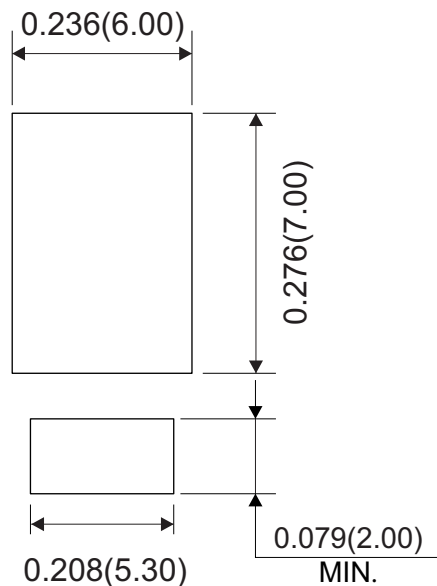

Standard Packaging

Case Type	REEL PACK	
	REEL (pcs)	Reel Size (inch)
SMC(Z5-T)	3,000	13