

# Cree® XLamp® CXA1507 LED



## PRODUCT DESCRIPTION

The XLamp® CXA1507 LED array expands Cree’s family of high-flux, multi-die arrays in a smaller, easy-to-use platform. With XLamp LED lighting-class reliability, the CXA1507’s small, uniform emitting surface enables both directional and non-directional lighting applications including lamp retrofit and luminaire designs. Available in 2-step, 3-step and 4-step color consistency, and featuring a 9-mm optical source, the CXA1507 brings new levels of flux and efficacy to this form factor.

The [CX Family LED Design Guide](#) provides basic information on the requirements to use the CXA1507 LED successfully in luminaire designs.

## FEATURES

- Available in 4-step, 3-step and 2-step EasyWhite® bins at 2700 K, 3000 K, 3500 K, 4000 K & 5000 K CCT and 4-step EasyWhite bins at 5700 K & 6500 K CCT
- Available in ANSI white bins at 4000 K, 5000 K, 5700 K & 6500 K CCT
- Available in 70-, 80-, 90- and 93-minimum CRI options
- Forward voltage options: 18-V class & 36-V class
- 85 °C binning and characterization
- Maximum drive current: 750 mA (18 V), 375 mA (36 V)
- 115° viewing angle, uniform chromaticity profile
- Top-side solder connections
- Thermocouple attach point
- NEMA SSL-3 2011 standard flux bins
- RoHS and REACH compliant
- UL® recognized component (E349212)

## TABLE OF CONTENTS

|   |    |
|---|----|
| Characteristics .....   | 2  |
| Operating Limits.....   | 3  |
| Flux Characteristics, EasyWhite® Order Codes and Bins - 18 V..... | 4  |
| Flux Characteristics, ANSI White Order Codes and Bins - 18 V..... | 7  |
| Flux Characteristics, EasyWhite® Order Codes and Bins - 36 V..... | 8  |
| Flux Characteristics, ANSI White Order Codes and Bins - 36 V..... | 11 |
| Relative Spectral Power Distribution .....                        | 12 |
| Electrical Characteristics.....                                   | 13 |
| Relative Luminous Flux.....                                       | 14 |
| Typical Spatial Distribution.....                                 | 16 |
| Performance Groups - Brightness .....                             | 16 |
| Performance Groups - Chromaticity .....                           | 17 |
| Cree EasyWhite® Bins Plotted on the 1931 CIE Color Space .....    | 20 |
| Cree ANSI White Bins Plotted on the 1931 CIE Color Space .....    | 20 |
| Bin and Order Code Formats.....                                   | 21 |
| Mechanical Dimensions .....                                       | 21 |
| Thermal Design.....   | 22 |
| Notes .....   | 24 |
| Packaging.....  | 25 |



**CHARACTERISTICS**

| Characteristics                              | Unit    | Minimum | Typical | Maximum |
|--|---------|---------|---------|---------|
| Viewing angle (FWHM)                         | degrees |         | 115     |         |
| ESD withstand voltage (HBM per Mil-Std-883D) | V       |         |         | 8000    |
| DC forward current (18 V)                    | mA      |         |         | 750*    |
| DC forward current (36 V)                    | mA      |         |         | 375*    |
| Reverse current 18 V, 36 V)                  | mA      |         |         | 0.1     |
| Forward voltage (18 V, 400 mA, 85 °C)        | V       |         | 17.5    |         |
| Forward voltage (18 V, 400 mA, 25 °C)        | V       |         |         | 21      |
| Forward voltage (36 V, 200 mA, 85 °C)        | V       |         | 35      |         |
| Forward voltage (36 V, 200 mA, 25 °C)        | V       |         |         | 42      |

\* Refer to the Operating Limits section.

**OPERATING LIMITS**

The maximum current rating of the CXA1507 is dependent on the case temperature ( $T_c$ ) when the LED has reached thermal equilibrium under steady-state operation. The graphs shown below assume that the system design employs good thermal management (thermal interface material and heat sink) and may vary when poor thermal management is employed. Please refer to the Mechanical Dimensions section on page 21 for the location of the  $T_c$  measurement point.

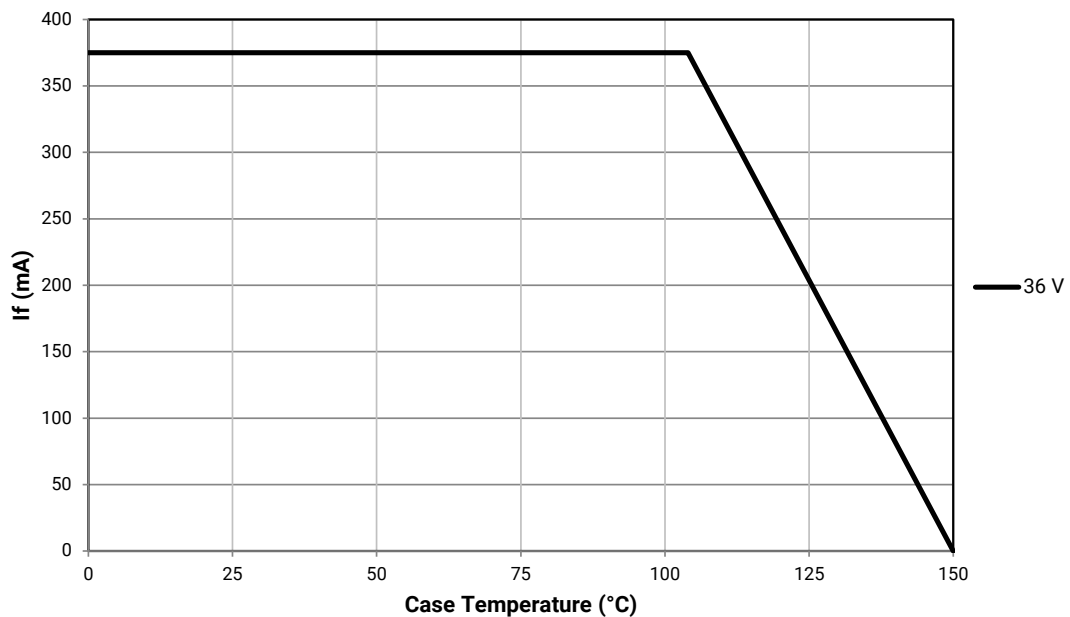
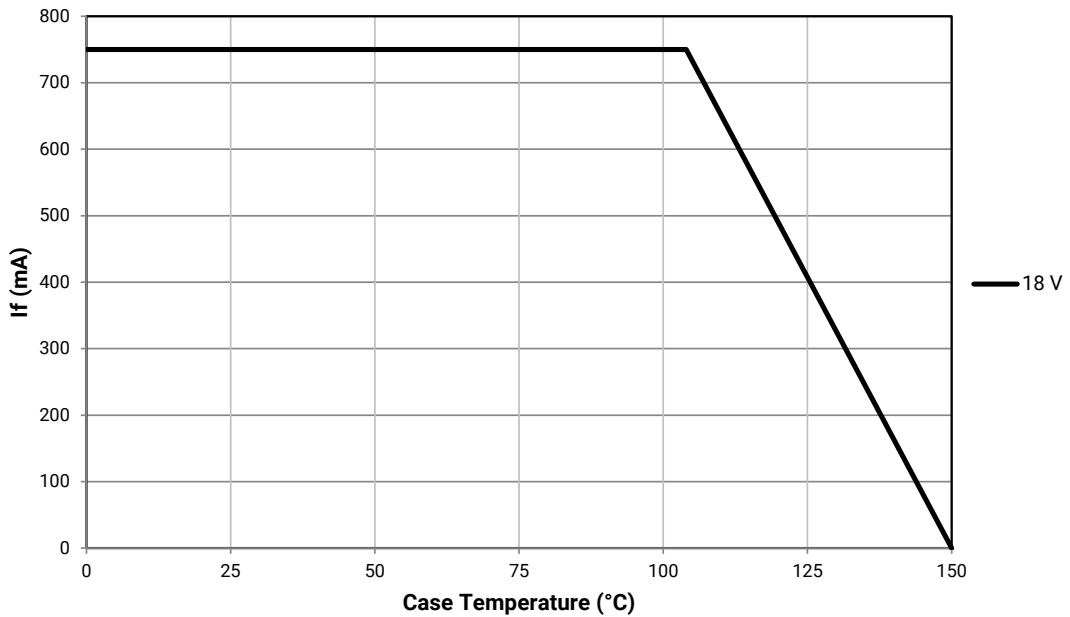

**FLUX CHARACTERISTICS, EASYWHITE® ORDER CODES AND BINS - 18 V ( $I_F = 400 \text{ mA}$ ,  $T_J = 85 \text{ °C}$ )**

The following table provides order codes for XLamp CXA1507 LEDs. For a complete description of the order code nomenclature, please see the Bin and Order Code Formats section (page 21).

| Nominal CCT | CRI |     | Minimum Luminous Flux |                   |                    | 2-Step |                          | 3-Step |            | 4-Step |                          |
|-------------|-----|-----|-----------------------|-------------------|--------------------|--------|--------------------------|--------|------------|--------|--------------------------|
|             | Min | Typ | Group                 | Flux (lm) @ 85 °C | Flux (lm) @ 25 °C* | Group  | Order Code               | Group  | Order Code | Group  | Order Code               |
| 6500 K      | 70  | 75  | G4                    | 840               | 938                |        |                          |        |            | 65F    | CXA1507-0000-000F00G465F |
|             |     |     | H2                    | 900               | 1005               |        |                          |        |            |        | CXA1507-0000-000F00H265F |
|             |     |     | H4                    | 970               | 1084               |        |                          |        |            |        | CXA1507-0000-000F00H465F |
|             | 80  | --- | G2                    | 780               | 871                |        |                          |        |            | 65F    | CXA1507-0000-000F0HG265F |
|             |     |     | G4                    | 840               | 938                |        |                          |        |            |        | CXA1507-0000-000F0HG465F |
|             |     |     | H2                    | 900               | 1005               |        |                          |        |            |        | CXA1507-0000-000F0HH265F |
| 5700 K      | 70  | 75  | G4                    | 840               | 938                |        |                          |        |            | 57F    | CXA1507-0000-000F00G457F |
|             |     |     | H2                    | 900               | 1005               |        |                          |        |            |        | CXA1507-0000-000F00H257F |
|             |     |     | H4                    | 970               | 1084               |        |                          |        |            |        | CXA1507-0000-000F00H457F |
|             | 80  | --- | G2                    | 780               | 871                |        |                          |        |            | 57F    | CXA1507-0000-000F0HG257F |
|             |     |     | G4                    | 840               | 938                |        |                          |        |            |        | CXA1507-0000-000F0HG457F |
|             |     |     | H2                    | 900               | 1005               |        |                          |        |            |        | CXA1507-0000-000F0HH257F |
| 5000 K      | 70  | 75  | G4                    | 840               | 938                | 50H    | CXA1507-0000-000F00G450H |        |            | 50F    | CXA1507-0000-000F00G450F |
|             |     |     | H2                    | 900               | 1005               |        | CXA1507-0000-000F00H250H |        |            |        | CXA1507-0000-000F00H250F |
|             |     |     | H4                    | 970               | 1084               |        | CXA1507-0000-000F00H450H |        |            |        | CXA1507-0000-000F00H450F |
|             | 80  | --- | G2                    | 780               | 871                | 50H    | CXA1507-0000-000F0HG250H | 50G    |            | 50F    | CXA1507-0000-000F0HG250F |
|             |     |     | G4                    | 840               | 938                |        | CXA1507-0000-000F0HG450H |        |            |        | CXA1507-0000-000F0HG450F |
|             |     |     | H2                    | 900               | 1005               |        | CXA1507-0000-000F0HH250H |        |            |        | CXA1507-0000-000F0HH250F |
|             | 90  | 95  | F2                    | 680               | 759                | 50H    | CXA1507-0000-000F0UF250H | 50G    |            | 50F    | CXA1507-0000-000F0UF250F |
|             |     |     | F4                    | 730               | 815                |        | CXA1507-0000-000F0UF450H |        |            |        | CXA1507-0000-000F0UF450F |
|             |     |     | G2                    | 780               | 871                |        | CXA1507-0000-000F0UG250H |        |            |        | CXA1507-0000-000F0UG250F |

- Notes**
- Cree maintains a tolerance of  $\pm 7\%$  on flux and power measurements,  $\pm 0.005$  on chromaticity (CCx, CCy) measurements and a tolerance of  $\pm 2$  on CRI measurements. See the Measurements section (page 24).
  - Cree XLamp CXA1507 LED order codes specify only a minimum flux bin and not a maximum. Cree may ship reels in flux bins higher than the minimum specified by the order code without advance notice. Shipments will always adhere to the chromaticity bin restrictions specified by the order code.
  - \* Flux values @ 25 °C are calculated and for reference only.

**FLUX CHARACTERISTICS, EASYWHITE® ORDER CODES AND BINS - 18 V (I<sub>F</sub> = 400 mA, T<sub>J</sub> = 85 °C) - CONTINUED**

| Nominal CCT | CRI |     | Minimum Luminous Flux |                   |                    | 2-Step |                          | 3-Step |            | 4-Step |                          |
|-------------|-----|-----|-----------------------|-------------------|--------------------|--------|--------------------------|--------|------------|--------|--------------------------|
|             | Min | Typ | Group                 | Flux (lm) @ 85 °C | Flux (lm) @ 25 °C* | Group  | Order Code               | Group  | Order Code | Group  | Order Code               |
| 4000 K      | 70  | 75  | G4                    | 840               | 938                | 40H    | CXA1507-0000-000F00G440H |        |            | 40F    | CXA1507-0000-000F00G440F |
|             |     |     | H2                    | 900               | 1005               |        | CXA1507-0000-000F00H240H |        |            |        | CXA1507-0000-000F00H240F |
|             |     |     | H4                    | 970               | 1084               |        | CXA1507-0000-000F00H440H |        |            |        | CXA1507-0000-000F00H440F |
|             | 80  | --- | G2                    | 780               | 871                | 40H    | CXA1507-0000-000F0HG240H | 40G    |            | 40F    | CXA1507-0000-000F0HG240F |
|             |     |     | G4                    | 840               | 938                |        | CXA1507-0000-000F0HG440H |        |            |        | CXA1507-0000-000F0HG440F |
|             |     |     | H2                    | 900               | 1005               |        | CXA1507-0000-000F0HH240H |        |            |        | CXA1507-0000-000F0HH240F |
|             | 90  | 95  | E4                    | 635               | 709                | 40H    | CXA1507-0000-000F0UE440H | 40G    |            | 40F    | CXA1507-0000-000F0UE440F |
|             |     |     | F2                    | 680               | 759                |        | CXA1507-0000-000F0UF240H |        |            |        | CXA1507-0000-000F0UF240F |
|             |     |     | F4                    | 730               | 815                |        | CXA1507-0000-000F0UF440H |        |            |        | CXA1507-0000-000F0UF440F |
| 3500 K      | 80  | --- | G2                    | 780               | 871                | 35H    | CXA1507-0000-000F00G235H | 35G    |            | 35F    | CXA1507-0000-000F00G235F |
|             |     |     | G4                    | 840               | 938                |        | CXA1507-0000-000F00G435H |        |            |        | CXA1507-0000-000F00G435F |
|             |     |     | H2                    | 900               | 1005               |        | CXA1507-0000-000F00H235H |        |            |        | CXA1507-0000-000F00H235F |
|             | 93  | 95  | E2                    | 590               | 659                | 35H    | CXA1507-0000-000F0YE235H | 35G    |            | 35F    | CXA1507-0000-000F0YE235F |
|             |     |     | E4                    | 635               | 709                |        | CXA1507-0000-000F0YE435H |        |            |        | CXA1507-0000-000F0YE435F |
|             |     |     | F2                    | 680               | 759                |        | CXA1507-0000-000F0YF235H |        |            |        | CXA1507-0000-000F0YF235F |
| 3000 K      | 80  | --- | F4                    | 730               | 815                | 30H    | CXA1507-0000-000F00F430H | 30G    |            | 30F    | CXA1507-0000-000F00F430F |
|             |     |     | G2                    | 780               | 871                |        | CXA1507-0000-000F00G230H |        |            |        | CXA1507-0000-000F00G230F |
|             |     |     | G4                    | 840               | 938                |        | CXA1507-0000-000F00G430H |        |            |        | CXA1507-0000-000F00G430F |
|             | 93  | 95  | D4                    | 550               | 614                | 30H    | CXA1507-0000-000F0YD430H | 30G    |            | 30F    | CXA1507-0000-000F0YD430F |
|             |     |     | E2                    | 590               | 659                |        | CXA1507-0000-000F0YE230H |        |            |        | CXA1507-0000-000F0YE230F |
|             |     |     | E4                    | 635               | 709                |        | CXA1507-0000-000F0YE430H |        |            |        | CXA1507-0000-000F0YE430F |

- Notes
- Cree maintains a tolerance of ±7% on flux and power measurements, ±0.005 on chromaticity (CCx, CCy) measurements and a tolerance of ±2 on CRI measurements. See the Measurements section (page 24).
  - Cree XLamp CXA1507 LED order codes specify only a minimum flux bin and not a maximum. Cree may ship reels in flux bins higher than the minimum specified by the order code without advance notice. Shipments will always adhere to the chromaticity bin restrictions specified by the order code.
  - \* Flux values @ 25 °C are calculated and for reference only.

**FLUX CHARACTERISTICS, EASYWHITE® ORDER CODES AND BINS - 18 V ( $I_F = 400 \text{ mA}$ ,  $T_J = 85 \text{ °C}$ ) - CONTINUED**

| Nominal CCT | CRI |     | Minimum Luminous Flux |                   |                    | 2-Step |                          | 3-Step |                          | 4-Step |                          |
|-------------|-----|-----|-----------------------|-------------------|--------------------|--------|--------------------------|--------|--------------------------|--------|--------------------------|
|             | Min | Typ | Group                 | Flux (lm) @ 85 °C | Flux (lm) @ 25 °C* | Group  | Order Code               | Group  | Order Code               | Group  | Order Code               |
| 2700 K      | 80  | --- | F4                    | 730               | 815                | 27H    | CXA1507-0000-000F00F427H | 27G    | CXA1507-0000-000F00G227G | 27F    | CXA1507-0000-000F00F427F |
|             |     |     | G2                    | 780               | 871                |        | CXA1507-0000-000F00G227H |        |                          |        | CXA1507-0000-000F00G227F |
|             |     |     | G4                    | 840               | 938                |        | CXA1507-0000-000F00G427H |        |                          |        | CXA1507-0000-000F00G427F |
|             | 93  | 95  | D2                    | 510               | 569                | 27H    | CXA1507-0000-000F0YD227H | 27G    | CXA1507-0000-000F0YD427G | 27F    | CXA1507-0000-000F0YD227F |
|             |     |     | D4                    | 550               | 614                |        | CXA1507-0000-000F0YD427H |        |                          |        | CXA1507-0000-000F0YD427F |
|             |     |     | E2                    | 590               | 659                |        | CXA1507-0000-000F0YE227H |        |                          |        | CXA1507-0000-000F0YE227F |

- Notes
- Cree maintains a tolerance of  $\pm 7\%$  on flux and power measurements,  $\pm 0.005$  on chromaticity (CCx, CCy) measurements and a tolerance of  $\pm 2$  on CRI measurements. See the Measurements section (page 24).
  - Cree XLamp CXA1507 LED order codes specify only a minimum flux bin and not a maximum. Cree may ship reels in flux bins higher than the minimum specified by the order code without advance notice. Shipments will always adhere to the chromaticity bin restrictions specified by the order code.
  - \* Flux values @ 25 °C are calculated and for reference only.

**FLUX CHARACTERISTICS, ANSI WHITE ORDER CODES AND BINS - 18 V ( $I_F = 400 \text{ mA}$ ,  $T_J = 85 \text{ °C}$ )**

The following table provides order codes for XLamp CXA1507 LEDs. For a complete description of the order code nomenclature, please see the Bin and Order Code Formats section (page 21).

| Nominal CCT | CRI |     | Minimum Luminous Flux |                   |                    | Chromaticity Regions    | Order Code               |
|-------------|-----|-----|-----------------------|-------------------|--------------------|-------------------------|--------------------------|
|             | Min | Typ | Group                 | Flux (lm) @ 85 °C | Flux (lm) @ 25 °C* |                         |                          |
| 6500 K      | 70  | 75  | G4                    | 840               | 938                | 1A0, 1B0, 1C0, 1D0, 65F | CXA1507-0000-000F00G40E1 |
|             |     |     | H2                    | 900               | 1005               |                         | CXA1507-0000-000F00H20E1 |
|             |     |     | H4                    | 970               | 1084               |                         | CXA1507-0000-000F00H40E1 |
|             | 80  | --- | G2                    | 780               | 871                | 1A0, 1B0, 1C0, 1D0, 65F | CXA1507-0000-000F0HG20E1 |
|             |     |     | G4                    | 840               | 938                |                         | CXA1507-0000-000F0HG40E1 |
|             |     |     | H2                    | 900               | 1005               |                         | CXA1507-0000-000F0HH20E1 |
| 5700 K      | 70  | 75  | G4                    | 840               | 938                | 2A0, 2B0, 2C0, 2D0, 57F | CXA1507-0000-000F00G40E2 |
|             |     |     | H2                    | 900               | 1005               |                         | CXA1507-0000-000F00H20E2 |
|             |     |     | H4                    | 970               | 1084               |                         | CXA1507-0000-000F00H40E2 |
|             | 80  | --- | G2                    | 780               | 871                | 2A0, 2B0, 2C0, 2D0, 57F | CXA1507-0000-000F0HG20E2 |
|             |     |     | G4                    | 840               | 938                |                         | CXA1507-0000-000F0HG40E2 |
|             |     |     | H2                    | 900               | 1005               |                         | CXA1507-0000-000F0HH20E2 |
| 5000 K      | 70  | 75  | G4                    | 840               | 938                | 3A0, 3B0, 3C0, 3D0, 50F | CXA1507-0000-000F00G40E3 |
|             |     |     | H2                    | 900               | 1005               |                         | CXA1507-0000-000F00H20E3 |
|             |     |     | H4                    | 970               | 1084               |                         | CXA1507-0000-000F00H40E3 |
|             | 80  | --- | G2                    | 780               | 871                | 3A0, 3B0, 3C0, 3D0, 50F | CXA1507-0000-000F0HG20E3 |
|             |     |     | G4                    | 840               | 938                |                         | CXA1507-0000-000F0HG40E3 |
|             |     |     | H2                    | 900               | 1005               |                         | CXA1507-0000-000F0HH20E3 |
| 4000 K      | 70  | 75  | G4                    | 840               | 938                | 5A0, 5B0, 5C0, 5D0, 40F | CXA1507-0000-000F00G40E5 |
|             |     |     | H2                    | 900               | 1005               |                         | CXA1507-0000-000F00H20E5 |
|             |     |     | H4                    | 970               | 1084               |                         | CXA1507-0000-000F00H40E5 |

**Notes**

- Cree maintains a tolerance of  $\pm 7\%$  on flux and power measurements,  $\pm 0.005$  on chromaticity (CCx, CCy) measurements and a tolerance of  $\pm 2$  on CRI measurements. See the Measurements section (page 24).
- Cree XLamp CXA1507 LED order codes specify only a minimum flux bin and not a maximum. Cree may ship reels in flux bins higher than the minimum specified by the order code without advance notice. Shipments will always adhere to the chromaticity bin restrictions specified by the order code.
- \* Flux values @ 25 °C are calculated and for reference only.

**FLUX CHARACTERISTICS, EASYWHITE® ORDER CODES AND BINS - 36 V (I<sub>F</sub> = 200 mA, T<sub>J</sub> = 85 °C)**

The following table provides order codes for XLamp CXA1507 LEDs. For a complete description of the order code nomenclature, please see the Bin and Order Code Formats section (page 21).

| Nominal CCT | CRI |     | Minimum Luminous Flux |                   |                    | 2-Step |                          | 3-Step |            | 4-Step |                          |
|-------------|-----|-----|-----------------------|-------------------|--------------------|--------|--------------------------|--------|------------|--------|--------------------------|
|             | Min | Typ | Group                 | Flux (lm) @ 85 °C | Flux (lm) @ 25 °C* | Group  | Order Code               | Group  | Order Code | Group  | Order Code               |
| 6500 K      | 70  | 75  | G4                    | 840               | 938                |        |                          |        |            | 65F    | CXA1507-0000-000N00G465F |
|             |     |     | H2                    | 900               | 1005               |        |                          |        |            |        | CXA1507-0000-000N00H265F |
|             |     |     | H4                    | 970               | 1084               |        |                          |        |            |        | CXA1507-0000-000N00H465F |
|             | 80  | --- | G2                    | 780               | 871                |        |                          |        |            | 65F    | CXA1507-0000-000N0HG265F |
|             |     |     | G4                    | 840               | 938                |        |                          |        |            |        | CXA1507-0000-000N0HG465F |
|             |     |     | H2                    | 900               | 1005               |        |                          |        |            |        | CXA1507-0000-000N0HH265F |
| 5700 K      | 70  | 75  | G4                    | 840               | 938                |        |                          |        |            | 57F    | CXA1507-0000-000N00G457F |
|             |     |     | H2                    | 900               | 1005               |        |                          |        |            |        | CXA1507-0000-000N00H257F |
|             |     |     | H4                    | 970               | 1084               |        |                          |        |            |        | CXA1507-0000-000N00H457F |
|             | 80  | --- | G2                    | 780               | 871                |        |                          |        |            | 57F    | CXA1507-0000-000N0HG257F |
|             |     |     | G4                    | 840               | 938                |        |                          |        |            |        | CXA1507-0000-000N0HG457F |
|             |     |     | H2                    | 900               | 1005               |        |                          |        |            |        | CXA1507-0000-000N0HH257F |
| 5000 K      | 70  | 75  | G4                    | 840               | 938                | 50H    | CXA1507-0000-000N00G450H |        |            | 50F    | CXA1507-0000-000N00G450F |
|             |     |     | H2                    | 900               | 1005               |        | CXA1507-0000-000N00H250H |        |            |        | CXA1507-0000-000N00H250F |
|             |     |     | H4                    | 970               | 1084               |        | CXA1507-0000-000N00H450H |        |            |        | CXA1507-0000-000N00H450F |
|             | 80  | --- | G2                    | 780               | 871                | 50H    | CXA1507-0000-000N0HG250H | 50G    |            | 50F    | CXA1507-0000-000N0HG250F |
|             |     |     | G4                    | 840               | 938                |        | CXA1507-0000-000N0HG450H |        |            |        | CXA1507-0000-000N0HG450F |
|             |     |     | H2                    | 900               | 1005               |        | CXA1507-0000-000N0HH250H |        |            |        | CXA1507-0000-000N0HH250F |
|             | 90  | 95  | F2                    | 680               | 759                | 50H    | CXA1507-0000-000N0UF250H | 50G    |            | 50F    | CXA1507-0000-000N0UF250F |
|             |     |     | F4                    | 730               | 815                |        | CXA1507-0000-000N0UF450H |        |            |        | CXA1507-0000-000N0UF450F |
|             |     |     | G2                    | 780               | 871                |        | CXA1507-0000-000N0UG250H |        |            |        | CXA1507-0000-000N0UG250F |

- Notes**
- Cree maintains a tolerance of ±7% on flux and power measurements, ±0.005 on chromaticity (CCx, CCy) measurements and a tolerance of ±2 on CRI measurements. See the Measurements section (page 24).
  - Cree XLamp CXA1507 LED order codes specify only a minimum flux bin and not a maximum. Cree may ship reels in flux bins higher than the minimum specified by the order code without advance notice. Shipments will always adhere to the chromaticity bin restrictions specified by the order code.
  - \* Flux values @ 25 °C are calculated and for reference only.



**FLUX CHARACTERISTICS, EASYWHITE® ORDER CODES AND BINS - 36 V (I<sub>F</sub> = 200 mA, T<sub>J</sub> = 85 °C) - CONTINUED**

| Nominal CCT | CRI    |     | Minimum Luminous Flux |                   |                    | 2-Step |                          | 3-Step                   |                          | 4-Step                   |                          |                          |
|-------------|--------|-----|-----------------------|-------------------|--------------------|--------|--------------------------|--------------------------|--------------------------|--------------------------|--------------------------|--------------------------|
|             | Min    | Typ | Group                 | Flux (lm) @ 85 °C | Flux (lm) @ 25 °C* | Group  | Order Code               | Group                    | Order Code               | Group                    | Order Code               |                          |
| 4000 K      | 70     | 75  | G4                    | 840               | 938                | 40H    | CXA1507-0000-000N00G440H |                          |                          | 40F                      | CXA1507-0000-000N00G440F |                          |
|             |        |     | H2                    | 900               | 1005               |        | CXA1507-0000-000N00H240H |                          |                          |                          | CXA1507-0000-000N00H240F |                          |
|             |        |     | H4                    | 970               | 1084               |        | CXA1507-0000-000N00H440H |                          |                          |                          | CXA1507-0000-000N00H440F |                          |
|             | 80     | --- | G2                    | 780               | 871                | 40H    | CXA1507-0000-000N0HG240H | 40G                      | CXA1507-0000-000N0HG440G | 40F                      | CXA1507-0000-000N0G240F  |                          |
|             |        |     | G4                    | 840               | 938                |        | CXA1507-0000-000N0HG440H |                          |                          |                          | CXA1507-0000-000N0HG440F |                          |
|             |        |     | H2                    | 900               | 1005               |        | CXA1507-0000-000N0HH240H |                          |                          |                          | CXA1507-0000-000N0HH240F |                          |
|             | 90     | 95  | E4                    | 635               | 709                | 40H    | CXA1507-0000-000N0UE440H | 40G                      | CXA1507-0000-000N0UF240G | 40F                      | CXA1507-0000-000N0UE440F |                          |
|             |        |     | F2                    | 680               | 759                |        | CXA1507-0000-000N0UF240H |                          |                          |                          | CXA1507-0000-000N0UF240F |                          |
|             |        |     | F4                    | 730               | 815                |        | CXA1507-0000-000N0UF440H |                          |                          |                          | CXA1507-0000-000N0UF440F |                          |
|             | 3500 K | 80  | ---                   | G2                | 780                | 871    | 35H                      | CXA1507-0000-000N00G235H | 35G                      | CXA1507-0000-000N00G435G | 35F                      | CXA1507-0000-000N00G235F |
|             |        |     |                       | G4                | 840                | 938    |                          | CXA1507-0000-000N00G435H |                          |                          |                          | CXA1507-0000-000N00G435F |
|             |        |     |                       | H2                | 900                | 1005   |                          | CXA1507-0000-000N00H235H |                          |                          |                          | CXA1507-0000-000N00H235F |
| 93          |        | 95  | E2                    | 590               | 659                | 35H    | CXA1507-0000-000N0YE235H | 35G                      | CXA1507-0000-000N0YE435G | 35F                      | CXA1507-0000-000N0YE235F |                          |
|             |        |     | E4                    | 635               | 709                |        | CXA1507-0000-000N0YE435H |                          |                          |                          | CXA1507-0000-000N0YE435F |                          |
|             |        |     | F2                    | 680               | 759                |        | CXA1507-0000-000N0YF235H |                          |                          |                          | CXA1507-0000-000N0YF235F |                          |
| 3000 K      | 80     | --- | F4                    | 730               | 815                | 30H    | CXA1507-0000-000N00F430H | 30G                      | CXA1507-0000-000N00G230G | 30F                      | CXA1507-0000-000N00F430F |                          |
|             |        |     | G2                    | 780               | 871                |        | CXA1507-0000-000N00G230H |                          |                          |                          | CXA1507-0000-000N00G230F |                          |
|             |        |     | G4                    | 840               | 938                |        | CXA1507-0000-000N00G430H |                          |                          |                          | CXA1507-0000-000N00G430F |                          |
|             | 93     | 95  | D4                    | 550               | 614                | 30H    | CXA1507-0000-000N0YD430H | 30G                      | CXA1507-0000-000N0YE230G | 30F                      | CXA1507-0000-000N0YD430F |                          |
|             |        |     | E2                    | 590               | 659                |        | CXA1507-0000-000N0YE230H |                          |                          |                          | CXA1507-0000-000N0YE230F |                          |
|             |        |     | E4                    | 635               | 709                |        | CXA1507-0000-000N0YE430H |                          |                          |                          | CXA1507-0000-000N0YE430F |                          |

- Notes
- Cree maintains a tolerance of ±7% on flux and power measurements, ±0.005 on chromaticity (CCx, CCy) measurements and a tolerance of ±2 on CRI measurements. See the Measurements section (page 24).
  - Cree XLamp CXA1507 LED order codes specify only a minimum flux bin and not a maximum. Cree may ship reels in flux bins higher than the minimum specified by the order code without advance notice. Shipments will always adhere to the chromaticity bin restrictions specified by the order code.
  - \* Flux values @ 25 °C are calculated and for reference only.

**FLUX CHARACTERISTICS, EASYWHITE® ORDER CODES AND BINS - 36 V (I<sub>F</sub> = 200 mA, T<sub>J</sub> = 85 °C) - CONTINUED**

| Nominal CCT | CRI |     | Minimum Luminous Flux |                   |                    | 2-Step |                          | 3-Step |                          | 4-Step |                          |                          |
|-------------|-----|-----|-----------------------|-------------------|--------------------|--------|--------------------------|--------|--------------------------|--------|--------------------------|--------------------------|
|             | Min | Typ | Group                 | Flux (lm) @ 85 °C | Flux (lm) @ 25 °C* | Group  | Order Code               | Group  | Order Code               | Group  | Order Code               |                          |
| 2700 K      | 80  | --- | F4                    | 730               | 815                | 27H    | CXA1507-0000-000N00F427H | 27G    | CXA1507-0000-000N00G227G | 27F    | CXA1507-0000-000N00F427F |                          |
|             |     |     | G2                    | 780               | 871                |        | CXA1507-0000-000N00G227H |        |                          |        | CXA1507-0000-000N00G227G | CXA1507-0000-000N00G227F |
|             |     |     | G4                    | 840               | 938                |        | CXA1507-0000-000N00G427H |        |                          |        | CXA1507-0000-000N00G427G | CXA1507-0000-000N00G427F |
|             | 93  | 95  | D2                    | 510               | 569                | 27H    | CXA1507-0000-000N0YD227H | 27G    | CXA1507-0000-000N0YD427G | 27F    | CXA1507-0000-000N0YD227F |                          |
|             |     |     | D4                    | 550               | 614                |        | CXA1507-0000-000N0YD427H |        |                          |        | CXA1507-0000-000N0YD427G | CXA1507-0000-000N0YD427F |
|             |     |     | E2                    | 590               | 659                |        | CXA1507-0000-000N0YE227H |        |                          |        | CXA1507-0000-000N0YE227G | CXA1507-0000-000N0YE227F |

- Notes
- Cree maintains a tolerance of ±7% on flux and power measurements, ±0.005 on chromaticity (CCx, CCy) measurements and a tolerance of ±2 on CRI measurements. See the Measurements section (page 24).
  - Cree XLamp CXA1507 LED order codes specify only a minimum flux bin and not a maximum. Cree may ship reels in flux bins higher than the minimum specified by the order code without advance notice. Shipments will always adhere to the chromaticity bin restrictions specified by the order code.
  - \* Flux values @ 25 °C are calculated and for reference only.

**FLUX CHARACTERISTICS, ANSI WHITE ORDER CODES AND BINS - 36 V ( $I_F = 200 \text{ mA}$ ,  $T_J = 85 \text{ }^\circ\text{C}$ )**

The following table provides order codes for XLamp CXA1507 LEDs. For a complete description of the order code nomenclature, please see the Bin and Order Code Formats section (page 21).

| Nominal CCT | CRI |     | Minimum Luminous Flux |                   |                    | Chromaticity Regions    | Order Code               |
|-------------|-----|-----|-----------------------|-------------------|--------------------|-------------------------|--------------------------|
|             | Min | Typ | Group                 | Flux (lm) @ 85 °C | Flux (lm) @ 25 °C* |                         |                          |
| 6500 K      | 70  | 75  | G4                    | 840               | 938                | 1A0, 1B0, 1C0, 1D0, 65F | CXA1507-0000-000N00G40E1 |
|             |     |     | H2                    | 900               | 1005               |                         | CXA1507-0000-000N00H20E1 |
|             |     |     | H4                    | 970               | 1084               |                         | CXA1507-0000-000N00H40E1 |
|             | 80  | --- | G2                    | 780               | 871                | 1A0, 1B0, 1C0, 1D0, 65F | CXA1507-0000-000N0HG20E1 |
|             |     |     | G4                    | 840               | 938                |                         | CXA1507-0000-000N0HG40E1 |
|             |     |     | H2                    | 900               | 1005               |                         | CXA1507-0000-000N0HH20E1 |
| 5700 K      | 70  | 75  | G4                    | 840               | 938                | 2A0, 2B0, 2C0, 2D0, 57F | CXA1507-0000-000N00G40E2 |
|             |     |     | H2                    | 900               | 1005               |                         | CXA1507-0000-000N00H20E2 |
|             |     |     | H4                    | 970               | 1084               |                         | CXA1507-0000-000N00H40E2 |
|             | 80  | --- | G2                    | 780               | 871                | 2A0, 2B0, 2C0, 2D0, 57F | CXA1507-0000-000N0HG20E2 |
|             |     |     | G4                    | 840               | 938                |                         | CXA1507-0000-000N0HG40E2 |
|             |     |     | H2                    | 900               | 1005               |                         | CXA1507-0000-000N0HH20E2 |
| 5000 K      | 70  | 75  | G4                    | 840               | 938                | 3A0, 3B0, 3C0, 3D0, 50F | CXA1507-0000-000N00G40E3 |
|             |     |     | H2                    | 900               | 1005               |                         | CXA1507-0000-000N00H20E3 |
|             |     |     | H4                    | 970               | 1084               |                         | CXA1507-0000-000N00H40E3 |
|             | 80  | --- | G2                    | 780               | 871                | 3A0, 3B0, 3C0, 3D0, 50F | CXA1507-0000-000N0HG20E3 |
|             |     |     | G4                    | 840               | 938                |                         | CXA1507-0000-000N0HG40E3 |
|             |     |     | H2                    | 900               | 1005               |                         | CXA1507-0000-000N0HH20E3 |
| 4000 K      | 70  | 75  | G4                    | 840               | 938                | 5A0, 5B0, 5C0, 5D0, 40F | CXA1507-0000-000N00G40E5 |
|             |     |     | H2                    | 900               | 1005               |                         | CXA1507-0000-000N00H20E5 |
|             |     |     | H4                    | 970               | 1084               |                         | CXA1507-0000-000N00H40E5 |

**Notes**

- Cree maintains a tolerance of  $\pm 7\%$  on flux and power measurements,  $\pm 0.005$  on chromaticity (CCx, CCy) measurements and a tolerance of  $\pm 2$  on CRI measurements. See the Measurements section (page 24).
- Cree XLamp CXA1507 LED order codes specify only a minimum flux bin and not a maximum. Cree may ship reels in flux bins higher than the minimum specified by the order code without advance notice. Shipments will always adhere to the chromaticity bin restrictions specified by the order code.
- \* Flux values @ 25 °C are calculated and for reference only.

**RELATIVE SPECTRAL POWER DISTRIBUTION**

The following graph is the result of a series of pulsed measurements at 400 mA for the 18-V CXA1507 LED and 200 mA for the 36-V CXA1507 LED and  $T_j = 85\text{ }^\circ\text{C}$ .

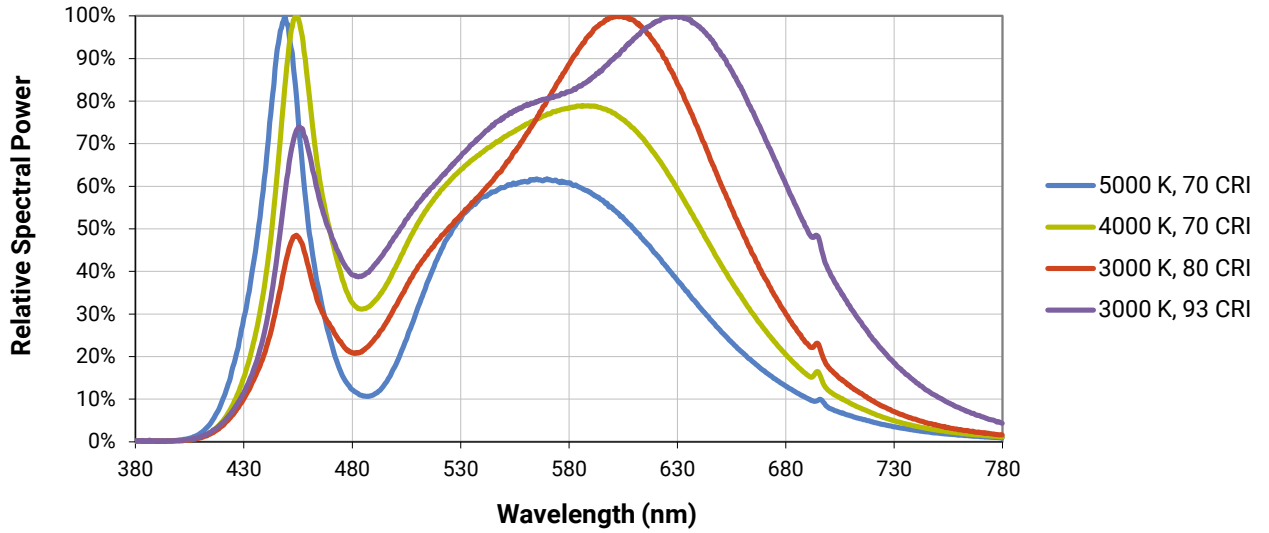

**ELECTRICAL CHARACTERISTICS**

The following graphs are the result of a series of steady-state measurements.

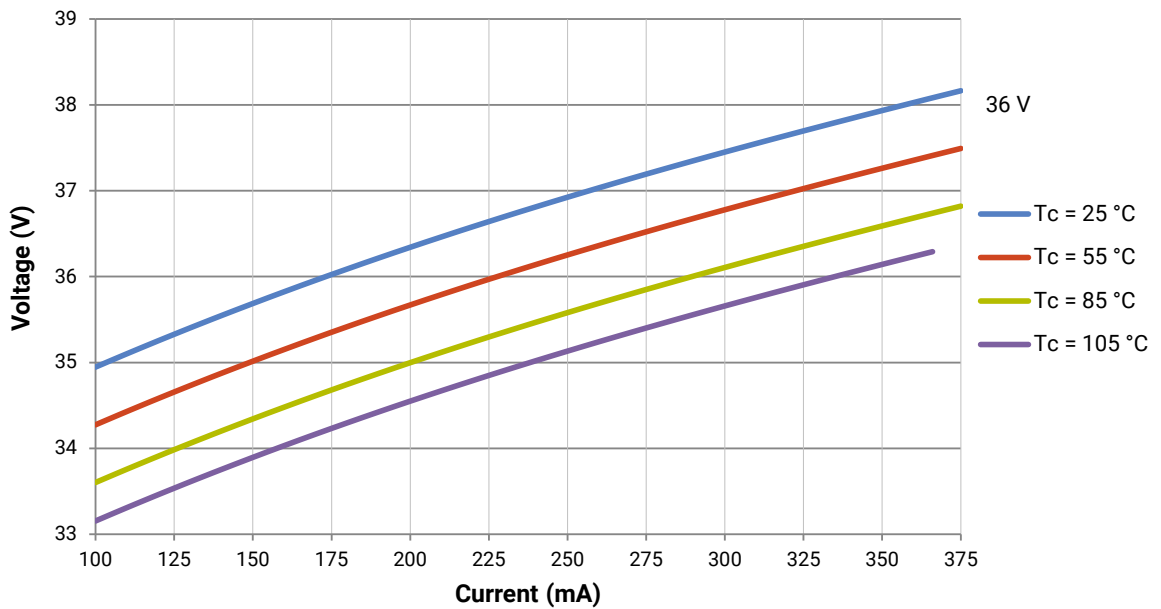
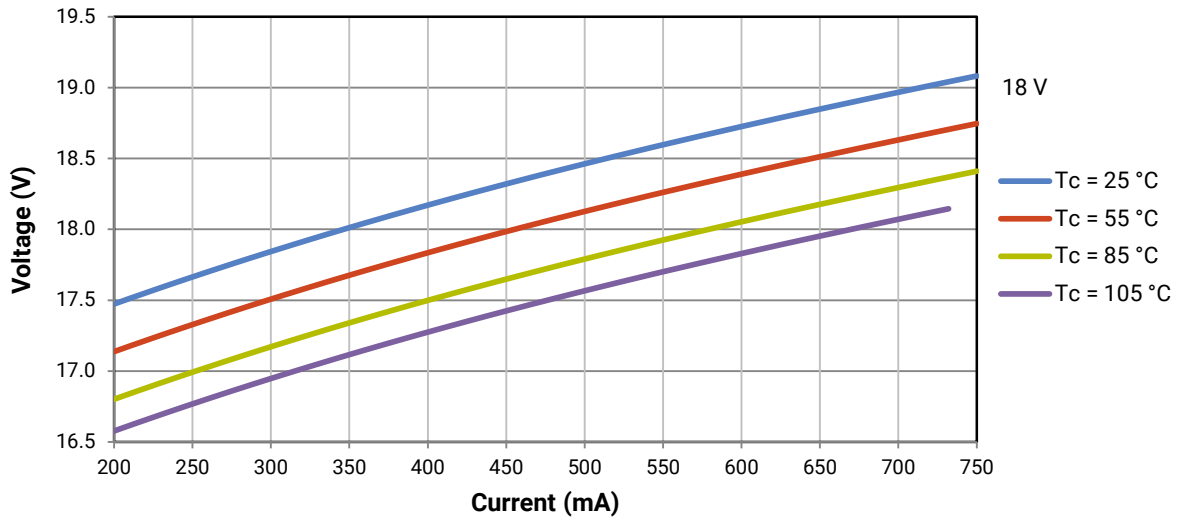

**RELATIVE LUMINOUS FLUX**

The relative luminous flux values provided below are the ratio of:

- Measurements of CXA1507 at steady-state operation at the given conditions, divided by
- Flux measured during binning, which is a pulsed measurement at 400 mA at  $T_j = 85\text{ }^\circ\text{C}$  for the 18-V CXA1507 LED.

Using the 18-V CXA1507 LED as an example, at steady-state operation of  $T_c = 25\text{ }^\circ\text{C}$ ,  $I_f = 650\text{ mA}$ , the relative luminous flux ratio is 160% in the chart below. A CXA1507 LED that measures 710 lm during binning will deliver 1136 lm ( $710 \times 1.6$ ) at steady-state operation of  $T_c = 25\text{ }^\circ\text{C}$ ,  $I_f = 650\text{ mA}$ .

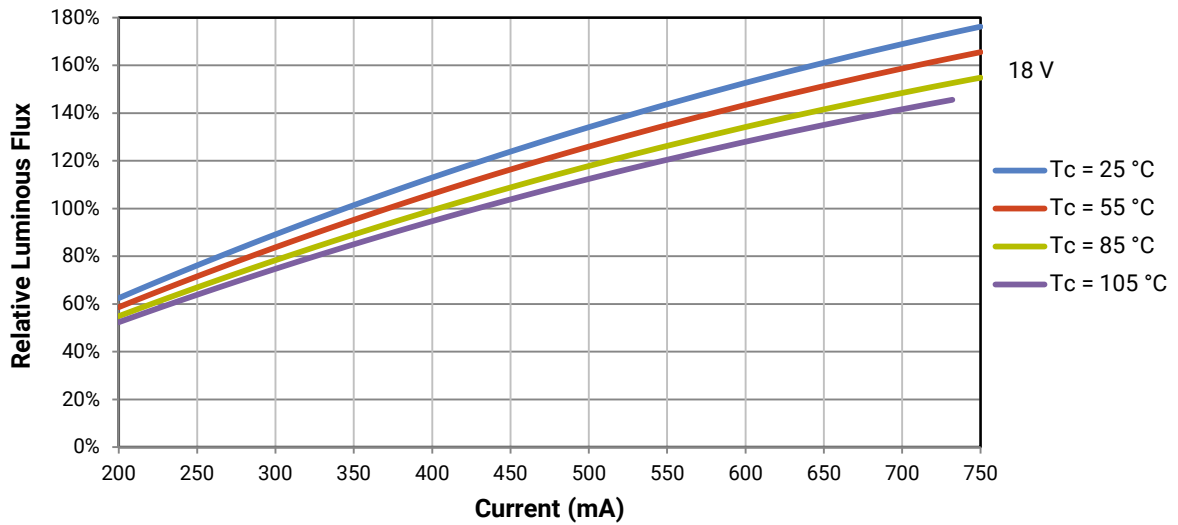

**RELATIVE LUMINOUS FLUX - CONTINUED**

The relative luminous flux values provided below are the ratio of:

- Measurements of CXA1507 at steady-state operation at the given conditions, divided by
- Flux measured during binning, which is a pulsed measurement at 200 mA at  $T_j = 85\text{ }^\circ\text{C}$  for the 36-V CXA1507 LED.

Using the 36-V CXA1507 LED as an example, at steady-state operation of  $T_c = 25\text{ }^\circ\text{C}$ ,  $I_f = 325\text{ mA}$ , the relative luminous flux ratio is 150% in the chart below. A CXA1507 LED that measures 710 lm during binning will deliver 1136 lm ( $710 \times 1.6$ ) at steady-state operation of  $T_c = 25\text{ }^\circ\text{C}$ ,  $I_f = 325\text{ mA}$ .

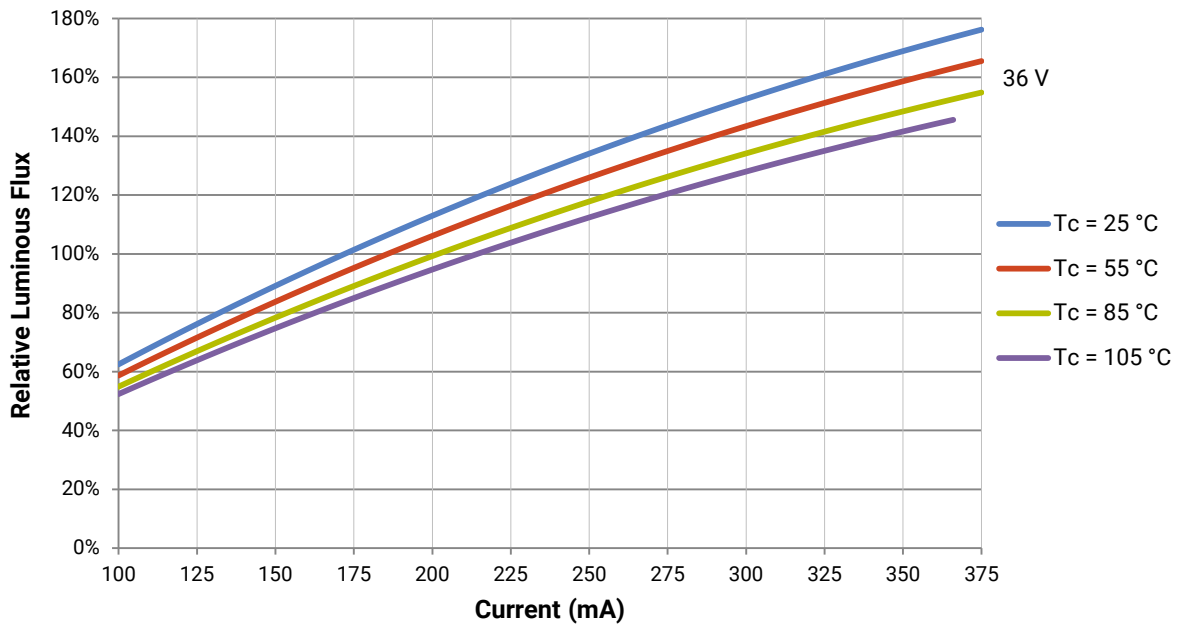

**TYPICAL SPATIAL DISTRIBUTION**

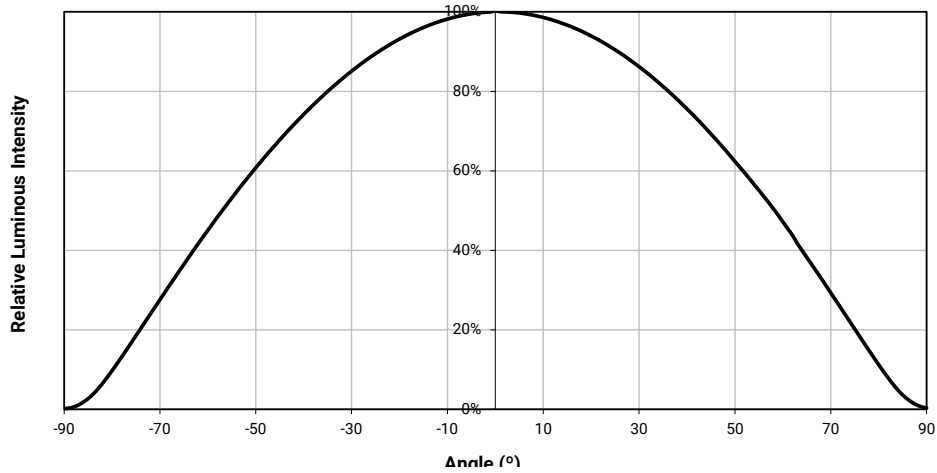

**PERFORMANCE GROUPS - BRIGHTNESS (18 V, I<sub>F</sub> = 400 mA; 36 V, I<sub>F</sub> = 200 mA, T<sub>J</sub> = 85 °C)**

XLamp CXA1507 LEDs are tested for luminous flux and placed into one of the following bins.

| Group Code | Minimum Luminous Flux | Maximum Luminous Flux |
|------------|-----------------------|-----------------------|
| D2         | 510                   | 550                   |
| D4         | 550                   | 590                   |
| E2         | 590                   | 635                   |
| E4         | 635                   | 680                   |
| F2         | 680                   | 730                   |
| F4         | 730                   | 780                   |
| G2         | 780                   | 840                   |
| G4         | 840                   | 900                   |
| H2         | 900                   | 970                   |
| H4         | 970                   | 1040                  |
| J2         | 1040                  | 1120                  |



**PERFORMANCE GROUPS - CHROMATICITY ( $T_j = 85\text{ }^\circ\text{C}$ )**

XLamp CXA1507 LEDs are tested for chromaticity and placed into one of the regions defined by the following bounding coordinates.

| EasyWhite Color Temperatures – 2-Step |        |        |        |
|---------------------------------------|--------|--------|--------|
| Code                                  | CCT    | x      | y      |
| 50H                                   | 5000 K | 0.3429 | 0.3507 |
|                                       |        | 0.3434 | 0.3571 |
|                                       |        | 0.3475 | 0.3604 |
|                                       |        | 0.3469 | 0.3539 |
| 40H                                   | 4000 K | 0.3784 | 0.3741 |
|                                       |        | 0.3804 | 0.3818 |
|                                       |        | 0.3867 | 0.3857 |
|                                       |        | 0.3844 | 0.3778 |
| 35H                                   | 3500 K | 0.4030 | 0.3857 |
|                                       |        | 0.4061 | 0.3941 |
|                                       |        | 0.4132 | 0.3976 |
|                                       |        | 0.4099 | 0.3890 |
| 30H                                   | 3000 K | 0.4291 | 0.3973 |
|                                       |        | 0.4333 | 0.4062 |
|                                       |        | 0.4395 | 0.4084 |
|                                       |        | 0.4351 | 0.3994 |
| 27H                                   | 2700 K | 0.4528 | 0.4046 |
|                                       |        | 0.4578 | 0.4138 |
|                                       |        | 0.4638 | 0.4152 |
|                                       |        | 0.4586 | 0.4060 |

| EasyWhite Color Temperatures – 3-Step Ellipse |        |              |        |            |            |                    |
|---|--------|--------------|--------|------------|------------|--------------------|
| Bin Code                                      | CCT    | Center Point |        | Major Axis | Minor Axis | Rotation Angle (°) |
|   |        | x            | y      | a          | b          |                    |
| 50G   | 5000 K | 0.3447       | 0.3553 | 0.00840    | 0.00312    | 65.0               |
| 40G   | 4000 K | 0.3818       | 0.3797 | 0.00939    | 0.00402    | 53.7               |
| 35G   | 3500 K | 0.4073       | 0.3917 | 0.00927    | 0.00414    | 54.0               |
| 30G   | 3000 K | 0.4338       | 0.4030 | 0.00834    | 0.00408    | 53.2               |
| 27G   | 2700 K | 0.4577       | 0.4099 | 0.00834    | 0.00420    | 48.5               |

**PERFORMANCE GROUPS - CHROMATICITY ( $T_j = 85\text{ }^\circ\text{C}$ ) - CONTINUED**

| EasyWhite Color Temperatures – 4-Step |        |        |        |
|---------------------------------------|--------|--------|--------|
| Code                                  | CCT    | x      | y      |
| 65F                                   | 6500 K | 0.3097 | 0.3196 |
|                                       |        | 0.3079 | 0.3297 |
|                                       |        | 0.3164 | 0.3382 |
|                                       |        | 0.3176 | 0.3275 |
| 57F                                   | 5700 K | 0.3253 | 0.3325 |
|                                       |        | 0.3249 | 0.3439 |
|                                       |        | 0.3331 | 0.3514 |
|                                       |        | 0.3330 | 0.3393 |
| 50F                                   | 5000 K | 0.3407 | 0.3459 |
|                                       |        | 0.3415 | 0.3586 |
|                                       |        | 0.3499 | 0.3654 |
|                                       |        | 0.3484 | 0.3521 |
| 40F                                   | 4000 K | 0.3744 | 0.3685 |
|                                       |        | 0.3782 | 0.3837 |
|                                       |        | 0.3912 | 0.3917 |
|                                       |        | 0.3863 | 0.3758 |
| 35F                                   | 3500 K | 0.3981 | 0.3800 |
|                                       |        | 0.4040 | 0.3966 |
|                                       |        | 0.4186 | 0.4037 |
|                                       |        | 0.4116 | 0.3865 |
| 30F                                   | 3000 K | 0.4242 | 0.3919 |
|                                       |        | 0.4322 | 0.4096 |
|                                       |        | 0.4449 | 0.4141 |
|                                       |        | 0.4359 | 0.3960 |
| 27F                                   | 2700 K | 0.4475 | 0.3994 |
|                                       |        | 0.4573 | 0.4178 |
|                                       |        | 0.4695 | 0.4207 |
|                                       |        | 0.4589 | 0.4021 |

**PERFORMANCE GROUPS - CHROMATICITY ( $T_j = 85^\circ\text{C}$ ) - CONTINUED**

| ANSI White Bins |        |          |        |        |
|-----------------|--------|----------|--------|--------|
| Code            | CCT    | Bin Code | x      | y      |
| 0E1             | 6500 K | 1A0      | 0.3048 | 0.3207 |
|                 |        |          | 0.3130 | 0.3290 |
|                 |        |          | 0.3144 | 0.3186 |
|                 |        |          | 0.3068 | 0.3113 |
|                 |        | 1B0      | 0.3028 | 0.3304 |
|                 |        |          | 0.3115 | 0.3391 |
|                 |        |          | 0.3130 | 0.3290 |
|                 |        |          | 0.3048 | 0.3207 |
|                 |        | 1C0      | 0.3115 | 0.3391 |
|                 |        |          | 0.3205 | 0.3481 |
|                 |        |          | 0.3213 | 0.3373 |
|                 |        |          | 0.3130 | 0.3290 |
|                 |        | 1D0      | 0.3130 | 0.3290 |
|                 |        |          | 0.3213 | 0.3373 |
|                 |        |          | 0.3221 | 0.3261 |
|                 |        |          | 0.3144 | 0.3186 |

| ANSI White Bins |        |          |        |        |
|-----------------|--------|----------|--------|--------|
| Code            | CCT    | Bin Code | x      | y      |
| 0E2             | 5700 K | 2A0      | 0.3215 | 0.3350 |
|                 |        |          | 0.3290 | 0.3417 |
|                 |        |          | 0.3290 | 0.3300 |
|                 |        |          | 0.3222 | 0.3243 |
|                 |        | 2B0      | 0.3207 | 0.3462 |
|                 |        |          | 0.3290 | 0.3538 |
|                 |        |          | 0.3290 | 0.3417 |
|                 |        |          | 0.3215 | 0.3350 |
|                 |        | 2C0      | 0.3290 | 0.3538 |
|                 |        |          | 0.3376 | 0.3616 |
|                 |        |          | 0.3371 | 0.3490 |
|                 |        |          | 0.3290 | 0.3417 |
|                 |        | 2D0      | 0.3290 | 0.3417 |
|                 |        |          | 0.3371 | 0.3490 |
|                 |        |          | 0.3366 | 0.3369 |
|                 |        |          | 0.3290 | 0.3300 |

| ANSI White Bins |        |          |       |       |
|-----------------|--------|----------|-------|-------|
| Code            | CCT    | Bin Code | x     | y     |
| 0E3             | 5000 K | 3A0      | .3371 | .3490 |
|                 |        |          | .3451 | .3554 |
|                 |        |          | .3440 | .3427 |
|                 |        |          | .3366 | .3369 |
|                 |        | 3B0      | .3376 | .3616 |
|                 |        |          | .3463 | .3687 |
|                 |        |          | .3451 | .3554 |
|                 |        |          | .3371 | .3490 |
|                 |        | 3C0      | .3463 | .3687 |
|                 |        |          | .3551 | .3760 |
|                 |        |          | .3533 | .3620 |
|                 |        |          | .3451 | .3554 |
|                 |        | 3D0      | .3451 | .3554 |
|                 |        |          | .3533 | .3620 |
|                 |        |          | .3515 | .3487 |
|                 |        |          | .3440 | .3427 |

| ANSI White Bins |        |          |       |       |
|-----------------|--------|----------|-------|-------|
| Code            | CCT    | Bin Code | x     | y     |
| 0E5             | 4000 K | 5A0      | .3670 | .3578 |
|                 |        |          | .3702 | .3722 |
|                 |        |          | .3825 | .3798 |
|                 |        |          | .3783 | .3646 |
|                 |        | 5B0      | .3702 | .3722 |
|                 |        |          | .3736 | .3874 |
|                 |        |          | .3869 | .3958 |
|                 |        |          | .3825 | .3798 |
|                 |        | 5C0      | .3825 | .3798 |
|                 |        |          | .3869 | .3958 |
|                 |        |          | .4006 | .4044 |
|                 |        |          | .3950 | .3875 |
|                 |        | 5D0      | .3783 | .3646 |
|                 |        |          | .3825 | .3798 |
|                 |        |          | .3950 | .3875 |
|                 |        |          | .3898 | .3716 |

**CREE EASYWHITE® BINS PLOTTED ON THE 1931 CIE COLOR SPACE ( $T_j = 85\text{ }^\circ\text{C}$ )**

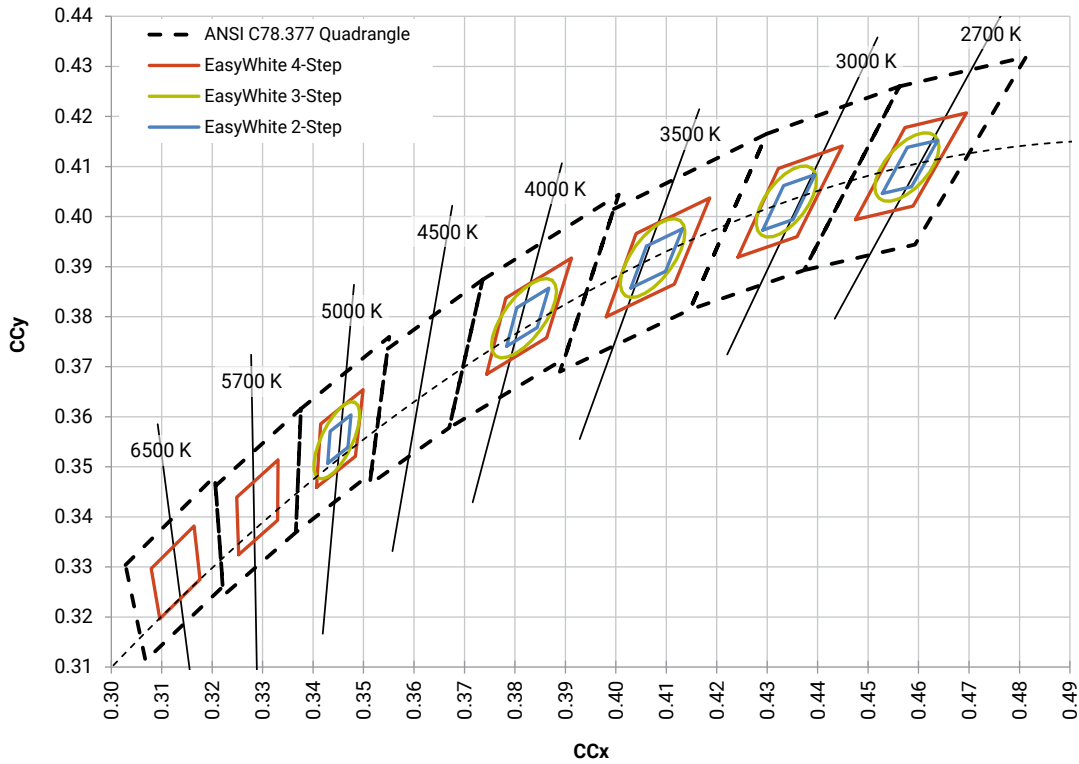

**CREE ANSI WHITE BINS PLOTTED ON THE 1931 CIE COLOR SPACE ( $T_j = 85\text{ }^\circ\text{C}$ )**

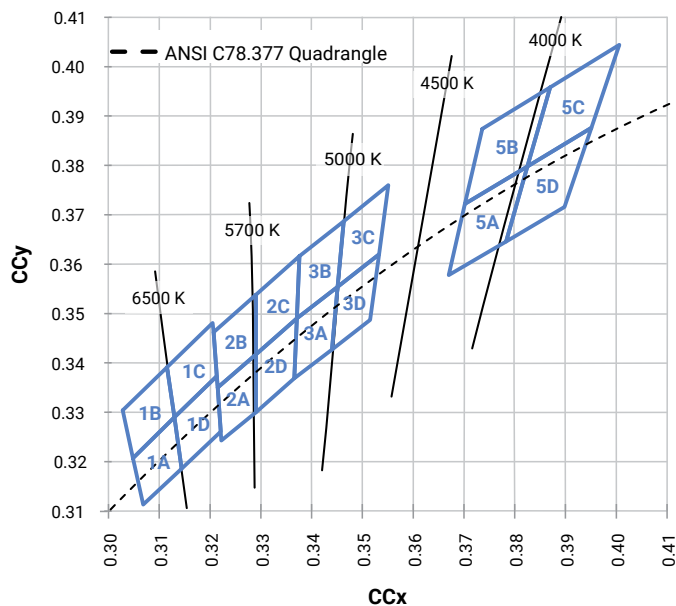

**BIN AND ORDER CODE FORMATS**

Bin codes and order codes are configured as follows:

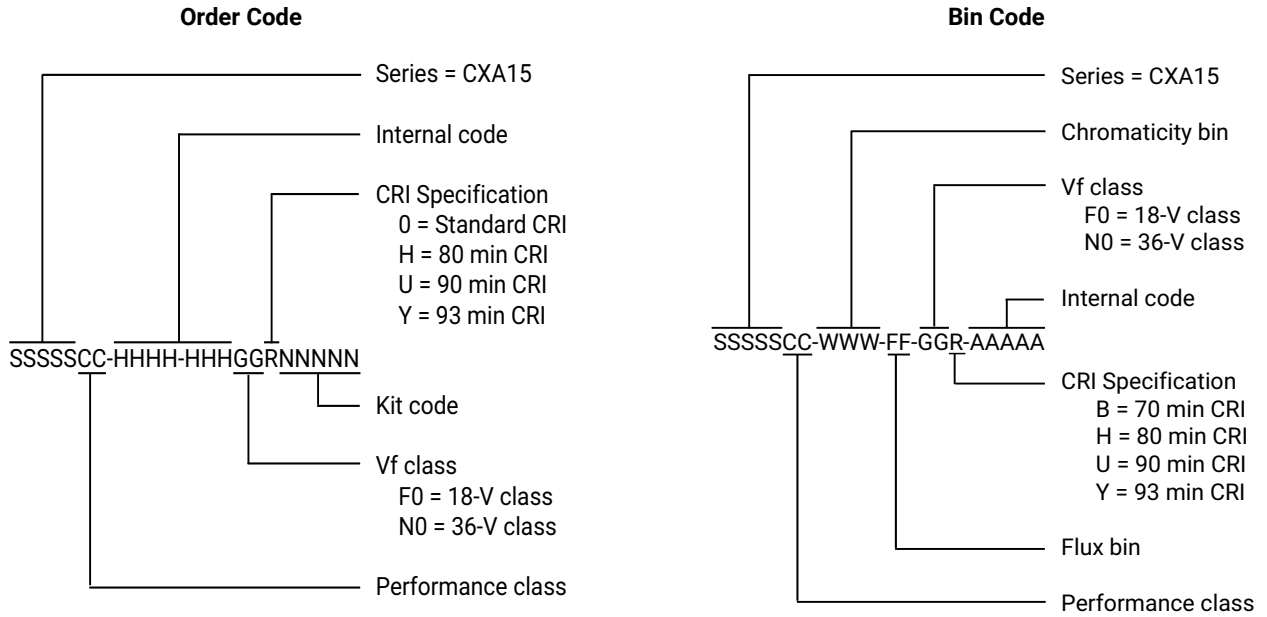

**MECHANICAL DIMENSIONS**

Dimensions are in mm.  
 Tolerances unless otherwise specified:  $\pm 0.13$   
 $\alpha^\circ \pm 1^\circ$

**Meaning of 1507X**

1507F = 18-V CXA1507  
 1507N = 36-V CXA1507

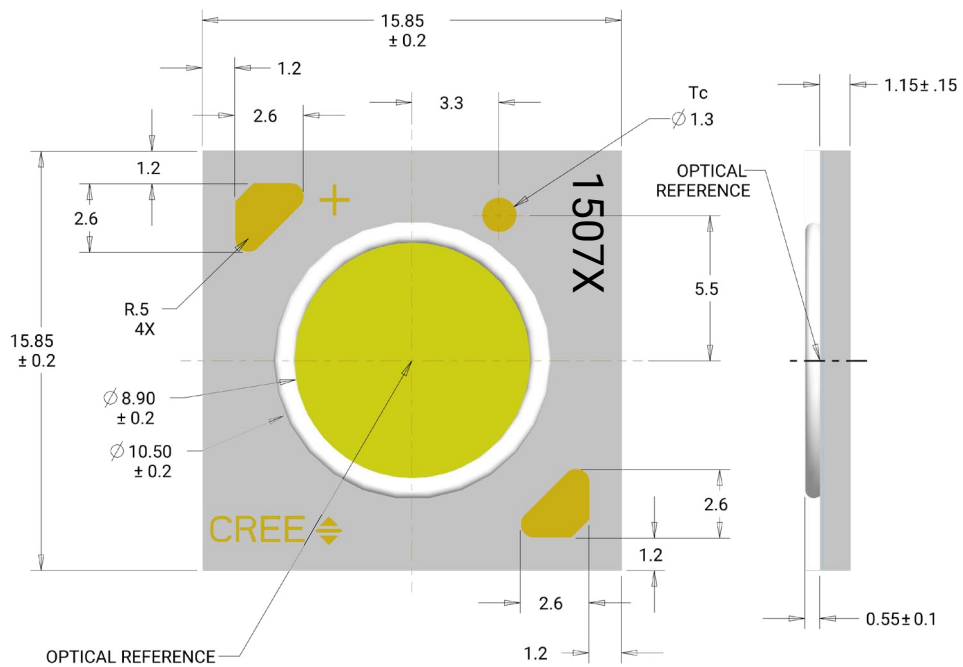

**THERMAL DESIGN**

The CXA family of LED arrays can include over a hundred different LED die inside one package, and thus over a hundred different junction temperatures ( $T_j$ ). Cree has intentionally removed junction-temperature-based operating limits and replaced the commonplace maximum  $T_j$  calculations with maximum ratings based on forward current ( $I_f$ ) and case temperature ( $T_c$ ). No additional calculations are required to ensure the CXA LED is being operated within its designed limits. Please refer to page 3 for the Operating Limit specification.

There is no need to calculate for  $T_j$  inside the package, as the thermal management design process, specifically from solder point ( $T_{sp}$ ) to ambient ( $T_a$ ), remains identical to any other LED component. For more information on thermal management of Cree XLamp LEDs, please refer to the [Thermal Management application note](#). For CXA soldering recommendations and more information on thermal interface materials (TIM) and connection methods, please refer to the [Cree CX Family LEDs soldering and handling document](#). The [CX Family LED Design Guide](#) provides basic information on the requirements to use Cree XLamp CXA LEDs successfully in luminaire designs.

To keep the CXA1507 LED at or below the maximum rated  $T_c$ , the case to ambient temperature thermal resistance ( $R_{c-a}$ ) must be at or below the maximum  $R_{c-a}$  value shown on the following graphs, depending on the operating environment. The y-axis in the graphs is a base 10 logarithmic scale.

As the figure at right shows, the  $R_{c-a}$  value is the sum of the thermal resistance of the TIM ( $R_{tim}$ ) plus the thermal resistance of the heat sink ( $R_{hs}$ ).

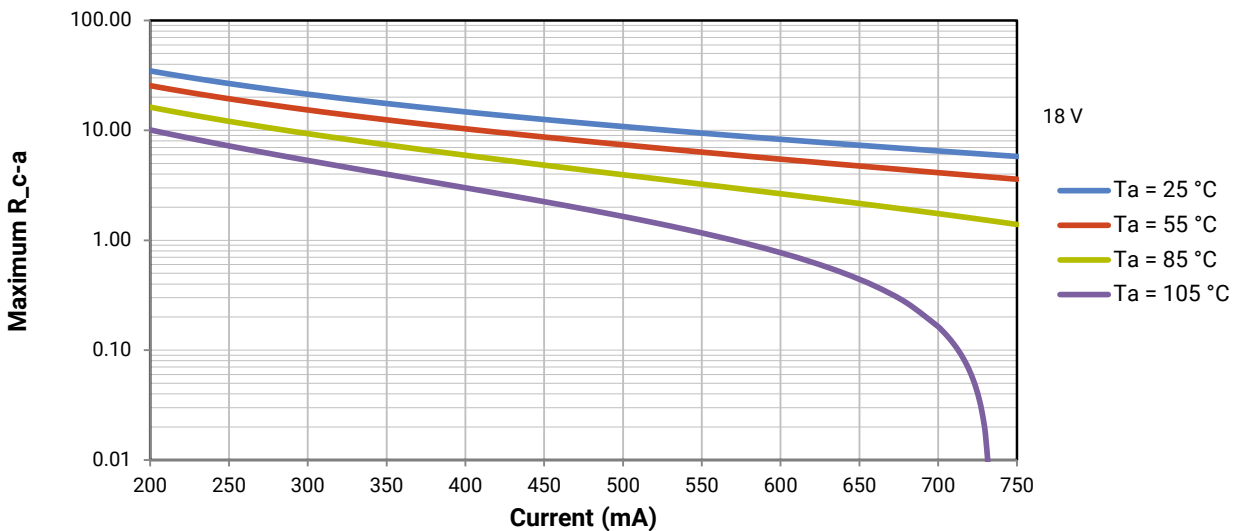
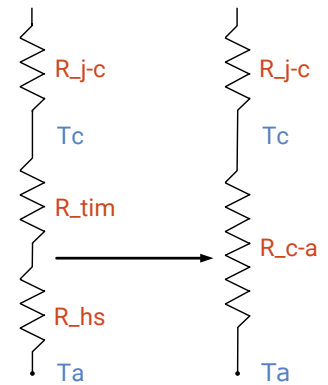

**THERMAL DESIGN - CONTINUED**

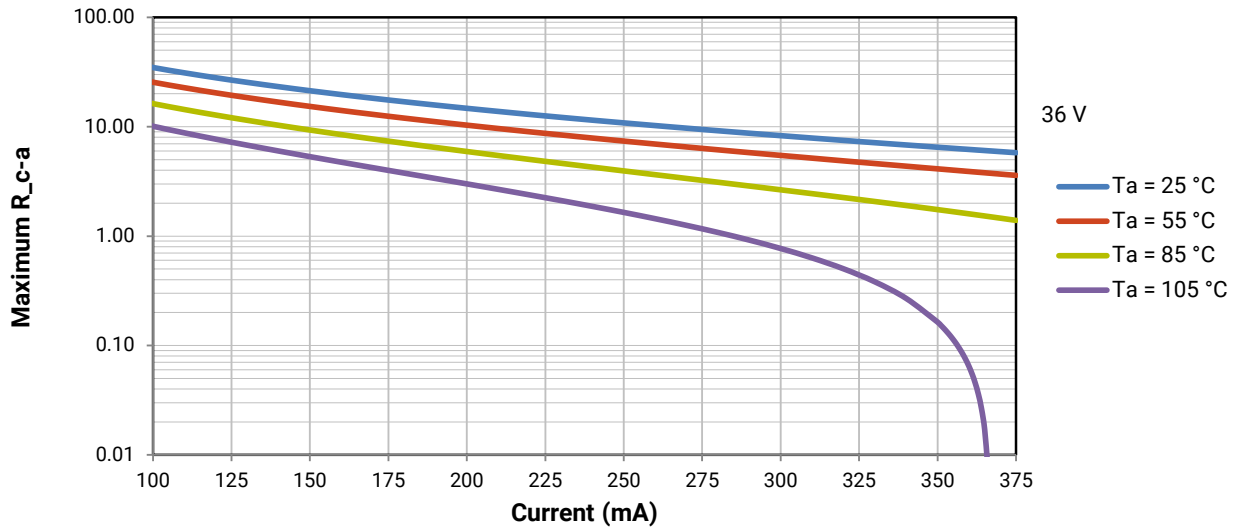

## NOTES

---

### Measurements

The luminous flux, radiant power, chromaticity and CRI measurements in this document are binning specifications only and solely represent product measurements as of the date of shipment. These measurements will change over time based on a number of factors that are not within Cree's control and are not intended or provided as operational specifications for the products. Calculated values are provided for informational purposes only and are not intended as specifications.

### Pre-Release Qualification Testing

Please read the [LED Reliability Overview](#) for details of the qualification process Cree applies to ensure long-term reliability for XLamp LEDs and details of Cree's pre-release qualification testing for XLamp LEDs.

### Lumen Maintenance

Cree now uses standardized IES LM-80-08 and TM-21-11 methods for collecting long-term data and extrapolating LED lumen maintenance. For information on the specific LM-80 data sets available for this LED, refer to the public [LM-80 results document](#).

Please read the [Long-Term Lumen Maintenance application note](#) for more details on Cree's lumen maintenance testing and forecasting. Please read the [Thermal Management application note](#) for details on how thermal design, ambient temperature, and drive current affect the LED junction temperature.

### RoHS Compliance

The levels of RoHS restricted materials in this product are below the maximum concentration values (also referred to as the threshold limits) permitted for such substances, or are used in an exempted application, in accordance with EU Directive 2011/65/EC (RoHS2), as implemented January 2, 2013. RoHS Declarations for this product can be obtained from your Cree representative or from the Product Documentation sections of [www.cree.com](http://www.cree.com).

### REACH Compliance

REACH substances of high concern (SVHCs) information is available for this product. Since the European Chemical Agency (ECHA) has published notice of their intent to frequently revise the SVHC listing for the foreseeable future, please contact a Cree representative to insure you get the most up-to-date REACH SVHC Declaration. REACH banned substance information (REACH Article 67) is also available upon request.

### UL® Recognized Component

Level 4 enclosure consideration. The LED package or a portion thereof has been investigated as a fire and electrical enclosure per ANSI/UL 8750.

### Vision Advisory

WARNING: Do not look at an exposed lamp in operation. Eye injury can result. For more information about LEDs and eye safety, please refer to the [LED Eye Safety application note](#).



**PACKAGING**

Cree CXA1507 LEDs are packaged in trays of 20. Five trays are sealed in an anti-static bag and placed inside a carton, for a total of 100 LEDs per carton. Each carton contains 100 LEDs from the same performance bin.

Dimensions are in inches.  
Tolerances:  $\pm .13$   
 $x^\circ \pm 1^\circ$

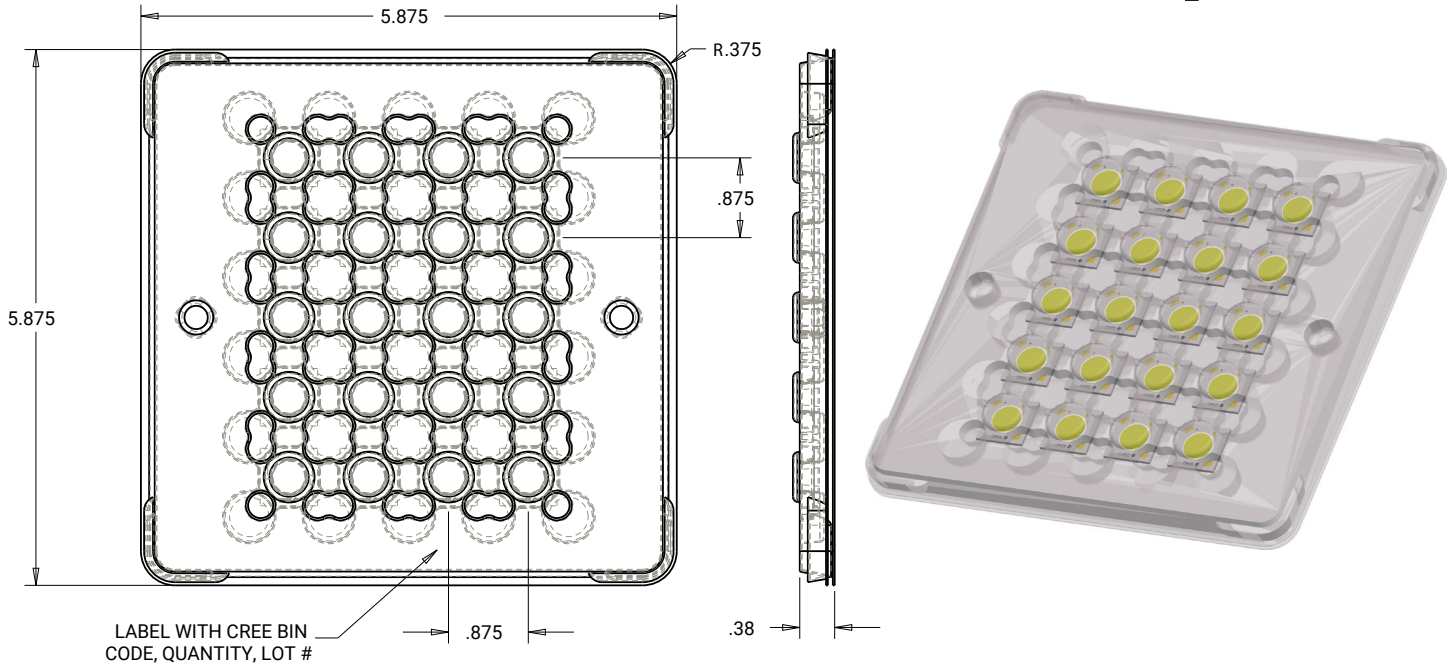

PATENT LABEL IS LOCATED ON UNDERSIDE OF CARTON

LABEL WITH CREE BIN CODE, QUANTITY, LOT #

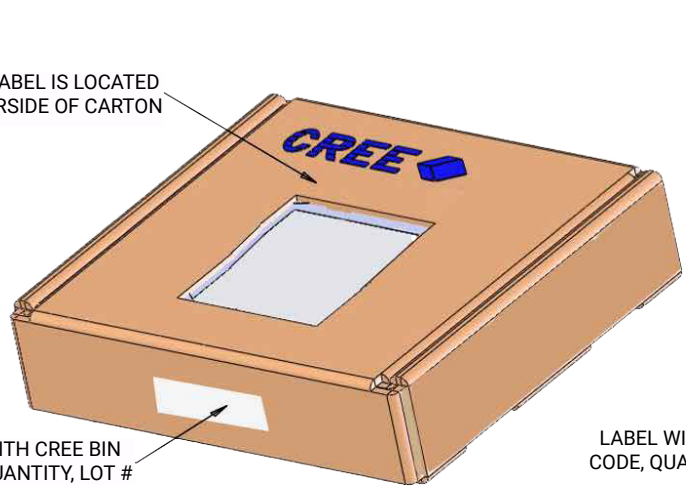

BAG

LABEL WITH CREE BIN CODE, QUANTITY, LOT #

