



CY7C291A CY7C292A/CY7C293A

2K x 8 Reprogrammable PROM

Features

- **Windowed for reprogrammability**
- **CMOS for optimum speed/power**
- **High speed**
 - 20 ns (commercial)
 - 25 ns (military)
- **Low power**
 - 660 mW (commercial and military)
- **Low standby power**
 - 220 mW (commercial and military)
- **EPROM technology 100% programmable**
- **Slim 300-mil or standard 600-mil packaging available**
- **5V ±10% V_{CC}, commercial and military**
- **TTL-compatible I/O**

- **Direct replacement for bipolar PROMs**
- **Capable of withstanding >2001V static discharge**

Functional Description

The CY7C291A, CY7C292A, and CY7C293A are high-performance 2K-word by 8-bit CMOS PROMs. They are packaged in 300-mil (7C291A, 7C293A) and 600-mil wide plastic and hermetic DIP packages (7C292A). The CY7C293A has an automatic power down feature which reduces the power consumption by over 70% when deselected. The 300-mil ceramic package may be equipped with an erasure window; when exposed to UV light the PROM is erased and can then be reprogrammed. The memory cells utilize proven EPROM floating-gate technology and byte-wide intelligent programming algorithms.

The CY7C291A, CY7C292A, and CY7C293A are plug-in replacements for bipolar devices and offer the advantages of lower power, reprogrammability, superior performance and programming yield. The EPROM cell requires only 12.5V for the supervoltage and low current requirements allow for gang programming. The EPROM cells allow for each memory location to be tested 100%, as each location is written into, erased, and repeatedly exercised prior to encapsulation. Each PROM is also tested for AC performance to guarantee that after customer programming the product will meet DC and AC specification limits.

A read is accomplished by placing an active LOW signal on CS₁, and active HIGH signals on CS₂ and CS₃. The contents of the memory location addressed by the address line (A₀ - A₁₀) will become available on the output lines (O₀ - O₇).

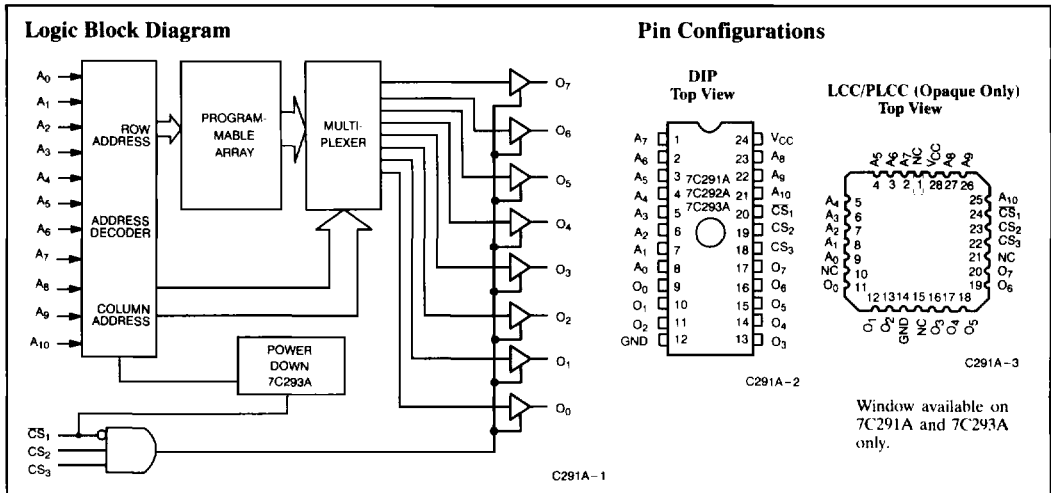

Selection Guide

			7C291A-20 7C292A-20 7C293A-20	7C291A-25 7C292A-25 7C293A-25	7C291A-35 7C292A-35 7C293A-35	7C291A-50 7C292A-50 7C293A-50
Maximum Access Time (ns)			20	25	35	50
Maximum Operating Current (mA)	Standard	Commercial	120	90	90	90
		Military		120	90	90
	L	Commercial		60	60	60
Standby Current (mA) 7C293A Only	Commercial		40	30	30	30
	Military			40	40	40



Maximum Ratings

(Above which the useful life may be impaired. For user guidelines, not tested.)

- Storage Temperature -65°C to +150°C
- Ambient Temperature with Power Applied -55°C to +125°C
- Supply Voltage to Ground Potential -0.5V to +7.0V
- DC Voltage Applied to Outputs in High Z State -0.5V to +7.0V
- DC Input Voltage -3.0V to +7.0V
- DC Program Voltage 13.0V
- UV Exposure 7258 Wsec/cm²

Static Discharge Voltage >2001V (per MIL-STD-883, Method 3015)

Latch-Up Current >200 mA

Operating Range

Range	Ambient Temperature	V _{CC}
Commercial	0°C to +70°C	5V ±10%
Industrial ^[1]	-40°C to +85°C	5V ±10%
Military ^[2]	-55°C to +125°C	5V ±10%

Electrical Characteristics Over the Operating Range^[3,4]

Parameter	Description	Test Conditions	7C291A-20 7C292A-20 7C293A-20		7C291A-25 7C292A-25 7C293A-25		7C291AL-25 7C292AL-25 7C293AL-25		Unit
			Min.	Max.	Min.	Max.	Min.	Max.	
V _{OH}	Output HIGH Voltage	V _{CC} = Min., I _{OH} = -4.0 mA	2.4		2.4		2.4		V
V _{OL}	Output LOW Voltage	V _{CC} = Min., I _{OL} = 16.0 mA		0.4		0.4		0.4	V
V _{IH}	Input HIGH Voltage	Guaranteed Input Logical HIGH Voltage for All Inputs	2.0	V _{CC}	2.0	V _{CC}	2.0	V _{CC}	V
V _{IL}	Input LOW Voltage	Guaranteed Input Logical LOW Voltage for All Inputs		0.8		0.8		0.8	V
I _{IX}	Input Load Current	GND ≤ V _{IN} ≤ V _{CC}	-10	+10	-10	+10	-10	+10	µA
V _{CD}	Input Diode Clamp Voltage		Note 4						
I _{OZ}	Output Leakage Current	GND ≤ V _{OUT} ≤ V _{CC} , Output Disabled	-10	+10	-10	+10	-10	+10	µA
I _{OS}	Output Short Circuit Current ^[5]	V _{CC} = Max., V _{OUT} = GND	-20	-90	-20	-90	-20	-90	mA
I _{CC}	V _{CC} Operating Supply Current	V _{CC} = Max., I _{OUT} = 0 mA	Com'l	120		90		60	mA
			Mil			120			
I _{SB}	Standby Supply Current (7C293A Only)	V _{CC} = Max., CS ₁ = V _{IH}	Com'l	40		30		30	mA
			Mil			40			
V _{PP}	Programming Supply Voltage		12	13	12	13	12	13	V
I _{PP}	Programming Supply Current			50		50		50	mA
V _{IHP}	Input HIGH Programming Voltage		3.0		3.0		3.0		V
V _{ILP}	Input LOW Programming Voltage			0.4		0.4		0.4	V

Notes:

1. Contact a Cypress representative for industrial temperature range specifications.
2. T_A is the "instant on" case temperature.
3. See the last page of this specification for Group A subgroup testing information.
4. See the "Introduction to CMOS PROMs" section of the Cypress Data Book for general information on testing.
5. For test purposes, not more than one output at a time should be shorted. Short circuit test duration should not exceed 30 seconds.

4



Electrical Characteristics Over the Operating Range^[3, 4] (continued)

Parameter	Description	Test Conditions	7C291AL-35, 50 7C292AL-35, 50 7C293AL-35, 50		7C291A-35, 50 7C292A-35, 50 7C293A-35, 50		Unit
			Min.	Max.	Min.	Max.	
V _{OH}	Output HIGH Voltage	V _{CC} = Min., I _{OH} = -4.0 mA	2.4		2.4		V
V _{OL}	Output LOW Voltage	V _{CC} = Min., I _{OL} = 16.0 mA		0.4		0.4	V
V _{IH}	Input HIGH Voltage	Guaranteed Input Logical HIGH Voltage for All Inputs	2.0		2.0		V
V _{IL}	Input LOW Voltage	Guaranteed Input Logical LOW Voltage for All Inputs		0.8		0.8	V
I _{IX}	Input Load Current	GND ≤ V _{IN} ≤ V _{CC}	-10	+10	-10	+10	μA
V _{CD}	Input Diode Clamp Voltage		Note 4				
I _{OZ}	Output Leakage Current	GND ≤ V _{OUT} ≤ V _{CC} , Output Disabled	-10	+10	-10	+10	μA
I _{OS}	Output Short Circuit Current ^[5]	V _{CC} = Max., V _{OUT} = GND	-20	-90	-20	-90	mA
I _{CC}	V _{CC} Operating Supply Current	V _{CC} = Max., V _{IN} = 2.0V I _{OUT} = 0 mA	Commercial	60	90		mA
			Military		90		
I _{SB}	Standby Supply Current (7C293A Only)	V _{CC} = Max., CS ₁ = V _{IH}	Commercial	30	30		mA
			Military		40		
V _{PP}	Programming Supply Voltage		12	13	12	13	V
I _{PP}	Programming Supply Current			50		50	mA
V _{IHP}	Input HIGH Programming Voltage		3.0		3.0		V
V _{ILP}	Input LOW Programming Voltage			0.4		0.4	V

Capacitance^[4]

Parameter	Description	Test Conditions	Max.	Unit
C _{IN}	Input Capacitance	T _A = 25°C, f = 1 MHz, V _{CC} = 5.0V	10	pF
C _{OUT}	Output Capacitance		10	pF

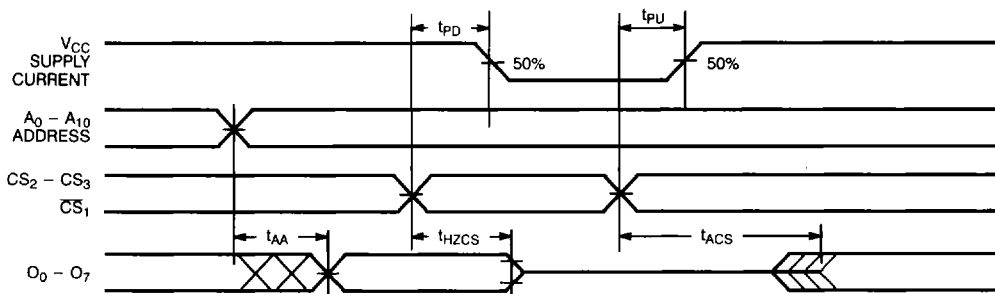
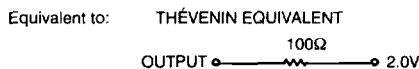
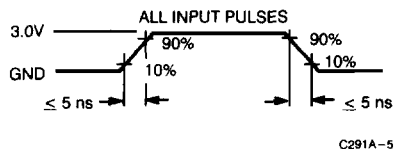
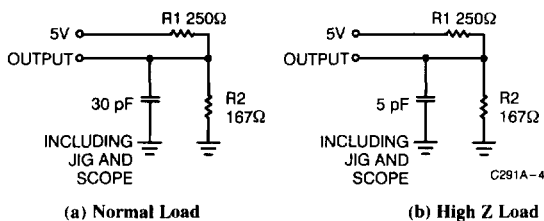
AC Test Loads and Waveforms⁽⁴⁾

C291A-6

Switching Characteristics Over the Operating Range^(3, 4)

Parameter	Description	7C291A-20 7C292A-20 7C293A-20		7C291A-25 7C292A-25 7C293A-25 7C291AL-25 7C292AL-25 7C293AL-25		7C291A-35 7C292A-35 7C293A-35 7C291AL-35 7C292AL-35 7C293AL-35		7C291A-50 7C292A-50 7C293A-50 7C291AL-50 7C292AL-50 7C293AL-50		Unit
		Min.	Max.	Min.	Max.	Min.	Max.	Min.	Max.	
		t_{AA}	Address to Output Valid		20		25		35	
t_{HZCS1}	Chip Select Inactive to High Z		15		15		20		20	ns
t_{ACS1}	Chip Select Active to Output Valid		15		15		20		20	ns
t_{HZCS2}	Chip Select Inactive to High Z (7C293A \overline{CS}_1 Only) ⁽⁶⁾		22		27		35		45	ns
t_{ACS2}	Chip Select Active to Output Valid (7C293A \overline{CS}_1 Only) ⁽⁶⁾		22		27		35		45	ns
t_{PU}	Chip Select Active to Power-Up (7C293A \overline{CS}_1 Only)	0		0		0		0		ns
t_{PD}	Chip Select Inactive to Power-Down (7C293A \overline{CS}_1 Only)		22		27		35		45	ns

Notes:

 6. t_{HZCS2} and t_{ACS2} refer to 7C293A \overline{CS}_1 only.

Erase Characteristics

Wavelengths of light less than 4000 Angstroms begin to erase these PROMs. For this reason, an opaque label should be placed over the window if the PROM is exposed to sunlight or fluorescent lighting for extended periods of time.

The recommended dose of ultraviolet light for erasure is a wavelength of 2537 Angstroms for a minimum dose (UV intensity x exposure time) of 25 Wsec/cm². For an ultraviolet lamp with a 12 mW/cm² power rating, the exposure time would be approximately 35 minutes.

These PROMs need to be within 1 inch of the lamp during erasure. Permanent damage may result if the PROM is exposed to high-intensity UV light for an extended period of time. 7258 Wsec/cm² is the recommended maximum dosage.

Programming Information

Programming support is available from Cypress as well as from a number of third-party software vendors. For detailed programming information, including a listing of software packages, please see the PROM Programming Information located at the end of this section. Programming algorithms can be obtained from any Cypress representative.

Table 1. Mode Selection

Mode	Pin Function ⁷⁾					
	Read or Output Disable	A ₁₀ - A ₀	CS ₃	CS ₂	CS ₁	O ₇ - O ₀
Other	A ₁₀ - A ₀	PGM	V _{FY}	V _{PP}	D ₇ - D ₀	
Read	A ₁₀ - A ₀	V _{IH}	V _{IH}	V _{IL}	O ₇ - O ₀	
Output Disable ⁸⁾	A ₁₀ - A ₀	X	X	V _{IH}	High Z	
Output Disable	A ₁₀ - A ₀	X	V _{IL}	X	High Z	
Output Disable	A ₁₀ - A ₀	V _{IL}	X	X	High Z	
Program	A ₁₀ - A ₀	V _{ILP}	V _{IHP}	V _{PP}	D ₇ - D ₀	
Program Verify	A ₁₀ - A ₀	V _{IHP}	V _{ILP}	V _{PP}	O ₇ - O ₀	
Program Inhibit	A ₁₀ - A ₀	V _{IHP}	V _{IHP}	V _{PP}	High Z	
Intelligent Program	A ₁₀ - A ₀	V _{ILP}	V _{IHP}	V _{PP}	D ₇ - D ₀	
Blank Check Zeros	A ₁₀ - A ₀	V _{IHP}	V _{ILP}	V _{PP}	Zeros	

Notes:

7. X = "don't care" but not to exceed V_{CC} + 5%.

8. The power-down mode for the CY7C293A is activated by deselecting CS₁.

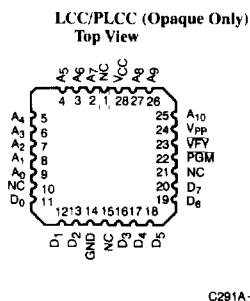
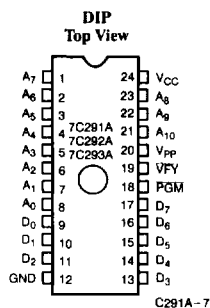
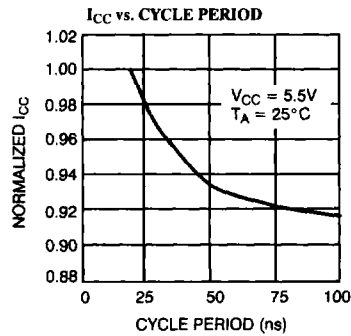
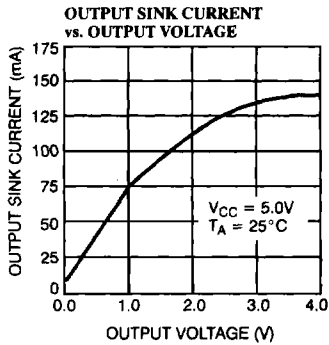
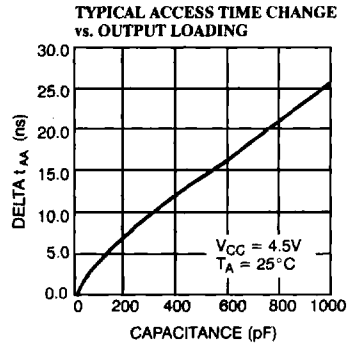
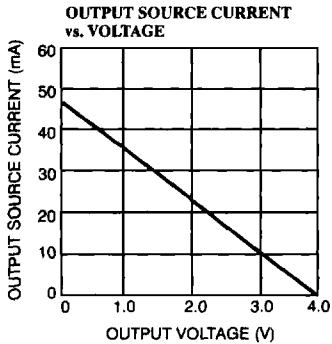
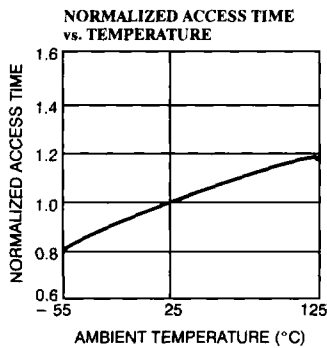
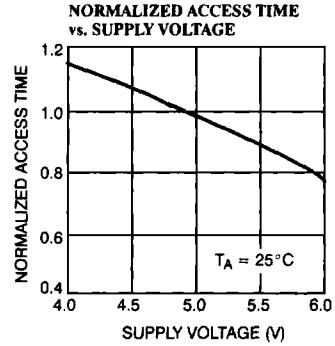
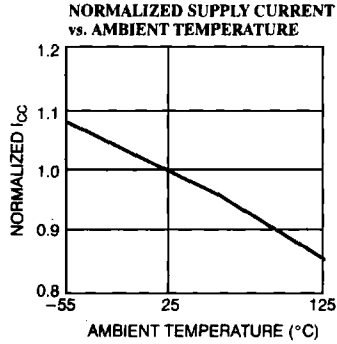
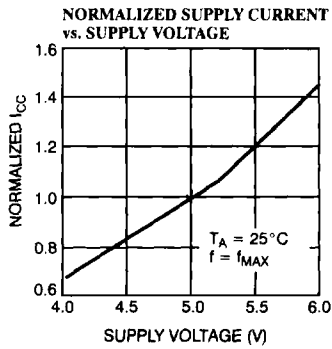

Figure 1. Programming Pinouts

Typical DC and AC Characteristics



Ordering Information⁽⁹⁾

Speed (ns)	I _{CC} (mA)	Ordering Code	Package Name	Package Type	Operating Range
20	120	CY7C291A-20JC	J64	28-Lead Plastic Leaded Chip Carrier	Commercial
		CY7C291A-20PC	P13	24-Lead (300-Mil) Molded DIP	
		CY7C291A-20SC	S13	24-Lead Molded SOIC	
		CY7C291A-20WC	W14	24-Lead (300-Mil) Windowed CerDIP	
25	60	CY7C291AL-25JC	J64	28-Lead Plastic Leaded Chip Carrier	Commercial
		CY7C291AL-25PC	P13	24-Lead (300-Mil) Molded DIP	
		CY7C291AL-25WC	W14	24-Lead (300-Mil) Windowed CerDIP	
		90	CY7C291A-25JC	J64	
	CY7C291A-25PC		P13	24-Lead (300-Mil) Molded DIP	
	CY7C291A-25SC		S13	24-Lead Molded SOIC	
	CY7C291A-25WC		W14	24-Lead (300-Mil) Windowed CerDIP	
	120	CY7C291A-25DMB	D14	24-Lead (300-Mil) CerDIP	Military
		CY7C291A-25LMB	L64	28-Square Leadless Chip Carrier	
		CY7C291A-25QMB	Q64	28-Pin Windowed Leadless Chip Carrier	
		CY7C291A-25TMB	T73	24-Lead Windowed Cerpack	
		CY7C291A-25WMB	W14	24-Lead (300-Mil) Windowed CerDIP	
30	120	CY7C291A-30DMB	D14	24-Lead (300-Mil) CerDIP	Military
		CY7C291A-30LMB	L64	28-Square Leadless Chip Carrier	
		CY7C291A-30QMB	Q64	28-Pin Windowed Leadless Chip Carrier	
		CY7C291A-30TMB	T73	24-Lead Windowed Cerpack	
		CY7C291A-30WMB	W14	24-Lead (300-Mil) Windowed CerDIP	
		35	60	CY7C291AL-35JC	
CY7C291AL-35PC	P13			24-Lead (300-Mil) Molded DIP	
CY7C291AL-35WC	W14			24-Lead (300-Mil) Windowed CerDIP	
90	CY7C291A-35SC		S13	24-Lead Molded SOIC	Commercial
	CY7C291A-35PC		P13	24-Lead (300-Mil) Molded DIP	
	CY7C291A-35WC		W14	24-Lead (300-Mil) Windowed CerDIP	
120	CY7C291A-35DMB		D14	24-Lead (300-Mil) CerDIP	Military
	CY7C291A-35LMB		L64	28-Square Leadless Chip Carrier	
	CY7C291A-35QMB		Q64	28-Pin Windowed Leadless Chip Carrier	
	CY7C291A-35TMB		T73	24-Lead Windowed Cerpack	
	CY7C291A-35WMB		W14	24-Lead (300-Mil) Windowed CerDIP	
50	60		CY7C291AL-50JC	J64	28-Lead Plastic Leaded Chip Carrier
		CY7C291AL-50PC	P13	24-Lead (300-Mil) Molded DIP	
		CY7C291AL-50WC	W14	24-Lead (300-Mil) Windowed CerDIP	
	90	CY7C291A-50SC	S13	24-Lead Molded SOIC	Commercial
		CY7C291A-50PC	P13	24-Lead (300-Mil) Molded DIP	
		CY7C291A-50WC	W14	24-Lead (300-Mil) Windowed CerDIP	
	90	CY7C291A-50DMB	D14	24-Lead (300-Mil) CerDIP	Military
		CY7C291A-50LMB	L64	28-Square Leadless Chip Carrier	
		CY7C291A-50QMB	Q64	28-Pin Windowed Leadless Chip Carrier	
		CY7C291A-50TMB	T73	24-Lead Windowed Cerpack	
		CY7C291A-50WMB	W14	24-Lead (300-Mil) Windowed CerDIP	

Note:

9. Most of these products are available in industrial temperature range. Contact a Cypress representative for specifications and product availability.



Ordering Information⁽⁹⁾ (continued)

Speed (ns)	I _{CC} (mA)	Ordering Code	Package Name	Package Type	Operating Range
20	120	CY7C292A-20DC	D12	24-Lead (600-Mil) CerDIP	Commercial
		CY7C292A-20PC	P11	24-Lead (600-Mil) Molded DIP	
25	120	CY7C292A-25DC	D12	24-Lead (600-Mil) CerDIP	Commercial
		CY7C292A-25PC	P11	24-Lead (600-Mil) Molded DIP	
		CY7C292A-25DMB	D12	24-Lead (600-Mil) CerDIP	Military
30	120	CY7C292A-30DMB	D12	24-Lead (600-Mil) CerDIP	Military
35	60	CY7C292AL-35PC	P11	24-Lead (600-Mil) Molded DIP	Commercial
	90	CY7C292A-35DC	D12	24-Lead (600-Mil) CerDIP	Commercial
		CY7C292A-35PC	P11	24-Lead (600-Mil) Molded DIP	
	120	CY7C292A-35DMB	D12	24-Lead (600-Mil) CerDIP	Military
50	60	CY7C292AL-50PC	P11	24-Lead (600-Mil) Molded DIP	Commercial
	90	CY7C292A-50DC	D12	24-Lead (600-Mil) CerDIP	Commercial
		CY7C292A-50PC	P11	24-Lead (600-Mil) Molded DIP	
	120	CY7C292A-50DMB	D12	24-Lead (600-Mil) CerDIP	Military

Speed (ns)	I _{CC} (mA)	Ordering Code	Package Name	Package Type	Operating Range
20	120	CY7C293A-20PC	P13	24-Lead (300-Mil) Molded DIP	Commercial
		CY7C293A-20WC	W14	24-Lead (300-Mil) Windowed CerDIP	
25	120	CY7C293A-25PC	P13	24-Lead (300-Mil) Molded DIP	Commercial
		CY7C293A-25WC	W14	24-Lead (300-Mil) Windowed CerDIP	
		CY7C293A-25DMB	D14	24-Lead (300-Mil) CerDIP	Military
		CY7C293A-25LMB	L64	28-Square Leadless Chip Carrier	
		CY7C293A-25QMB	Q64	28-Pin Windowed Leadless Chip Carrier	
		CY7C293A-25WMB	W14	24-Lead (300-Mil) Windowed CerDIP	
30	120	CY7C293A-30DMB	D14	24-Lead (300-Mil) CerDIP	Military
		CY7C293A-30LMB	L64	28-Square Leadless Chip Carrier	
		CY7C293A-30QMB	Q64	28-Pin Windowed Leadless Chip Carrier	
		CY7C293A-30WMB	W14	24-Lead (300-Mil) Windowed CerDIP	
35	60	CY7C293AL-35PC	P13	24-Lead (300-Mil) Molded DIP	Commercial
		CY7C293AL-35WC	W14	24-Lead (300-Mil) Windowed CerDIP	
	90	CY7C293A-35PC	P13	24-Lead (300-Mil) Molded DIP	Commercial
		CY7C293A-35WC	W14	24-Lead (300-Mil) Windowed CerDIP	
	90	CY7C293A-35DMB	D14	24-Lead (300-Mil) CerDIP	Military
		CY7C293A-35LMB	L64	28-Square Leadless Chip Carrier	
		CY7C293A-35QMB	Q64	28-Pin Windowed Leadless Chip Carrier	
		CY7C293A-35WMB	W14	24-Lead (300-Mil) Windowed CerDIP	
50	60	CY7C293AL-50PC	P13	24-Lead (300-Mil) Molded DIP	Commercial
		CY7C293AL-50WC	W14	24-Lead (300-Mil) Windowed CerDIP	
	90	CY7C293A-50PC	P13	24-Lead (300-Mil) Molded DIP	Commercial
		CY7C293A-50WC	W14	24-Lead (300-Mil) Windowed CerDIP	
	90	CY7C293A-50DMB	D14	24-Lead (300-Mil) CerDIP	Military
		CY7C293A-50LMB	L64	28-Square Leadless Chip Carrier	
		CY7C293A-50QMB	Q64	28-Pin Windowed Leadless Chip Carrier	
		CY7C293A-50WMB	W14	24-Lead (300-Mil) Windowed CerDIP	

4



MILITARY SPECIFICATIONS
Group A Subgroup Testing

DC Characteristics

Parameter	Subgroups
V _{OH}	1, 2, 3
V _{OL}	1, 2, 3
V _{IH}	1, 2, 3
V _{IL}	1, 2, 3
I _{Ix}	1, 2, 3
I _{OZ}	1, 2, 3
I _{CC}	1, 2, 3
I _{SB} ^[10]	1, 2, 3

Switching Characteristics

Parameter	Subgroups
t _{AA}	7, 8, 9, 10, 11
t _{ACS1} ^[11]	7, 8, 9, 10, 11
t _{ACS2} ^[10]	7, 8, 9, 10, 11

Notes:

10. 7C293A only.

11. 7C291A and 7C292A only.

Document #: 38-00075-3

SMD Cross Reference

SMD Number	Suffix	Cypress Number
5962-87650	01KX	CY7C291-50TMB
5962-87650	01LX	CY7C291-50WMB
5962-87650	013X	CY7C291-50QMB
5962-87650	03KX	CY7C291-35TMB
5962-87650	03LX	CY7C291-35WMB
5962-87650	033X	CY7C291-35QMB
5962-88680	01LX	CY7C293A-50WMB
5962-88680	01KX	CY7C293A-50TMB
5962-88680	013X	CY7C293A-50QMB
5962-88680	02LX	CY7C293A-35WMB
5962-88680	02KX	CY7C293A-35TMB
5962-88680	023X	CY7C293A-35QMB
5962-88680	03LX	CY7C293A-30WMB
5962-88680	03KX	CY7C293A-30TMB
5962-88680	033X	CY7C293A-30QMB
5962-88680	04LX	CY7C293A-25WMB
5962-88680	04KX	CY7C293A-25TMB
5962-88680	043X	CY7C293A-25QMB
5962-88734	02JX	CY7C292A-45DMB
5962-88734	02KX	CY7C291A-45KMB
5962-88734	02LX	CY7C291A-45DMB
5962-88734	023X	CY7C291A-45LMB
5962-88734	03JX	CY7C292A-35DMB
5962-88734	03KX	CY7C291A-35KMB
5962-88734	03LX	CY7C291A-35DMB
5962-88734	033X	CY7C291A-35LMB
5962-88734	04JX	CY7C292A-25DMB
5962-88734	04KX	CY7C291A-25KMB
5962-88734	04LX	CY7C291A-25DMB
5962-88734	043X	CY7C291A-25LMB