



**Features**

- Automatic power-down when deselected
- CMOS for optimum speed/power
- High speed  
— 10 ns
- Low active power  
— 935 mW
- Low Standby Power  
— 220 mW
- TTL-compatible inputs and outputs
- Capable of withstanding greater than 2001V electrostatic discharge

**Functional Description**

The CY7C185 and CY7C186 are high-performance CMOS static RAMs organized as 8192 words by 8 bits. Easy memory expansion is provided by an active LOW chip enable ( $\overline{CE}_1$ ), an active HIGH chip enable ( $CE_2$ ), and active LOW output enable ( $\overline{OE}$ ) and three-state drivers. Both devices have an automatic power-down feature ( $\overline{CE}_1$ ), reducing the power consumption by over 75% when deselected. The CY7C185 is in the space-saving 300-mil-wide DIP package and leadless chip carrier. The CY7C186 is in the standard 600-mil-wide package.

An active LOW write enable signal ( $\overline{WE}$ ) controls the writing/reading operation of

the memory. When  $\overline{CE}_1$  and  $\overline{WE}$  inputs are both LOW and  $CE_2$  is HIGH, data on the eight data input/output pins ( $I/O_0$  through  $I/O_7$ ) is written into the memory location addressed by the address present on the address pins ( $A_0$  through  $A_{12}$ ). Reading the device is accomplished by selecting the device and enabling the outputs,  $\overline{CE}_1$  and  $\overline{OE}$  active LOW,  $CE_2$  active HIGH, while  $\overline{WE}$  remains inactive or HIGH. Under these conditions, the contents of the location addressed by the information on address pins is present on the eight data input/output pins.

The input/output pins remain in a high-impedance state unless the chip is selected, outputs are enabled, and write enable ( $\overline{WE}$ ) is HIGH. A die coat is used to insure alpha immunity.

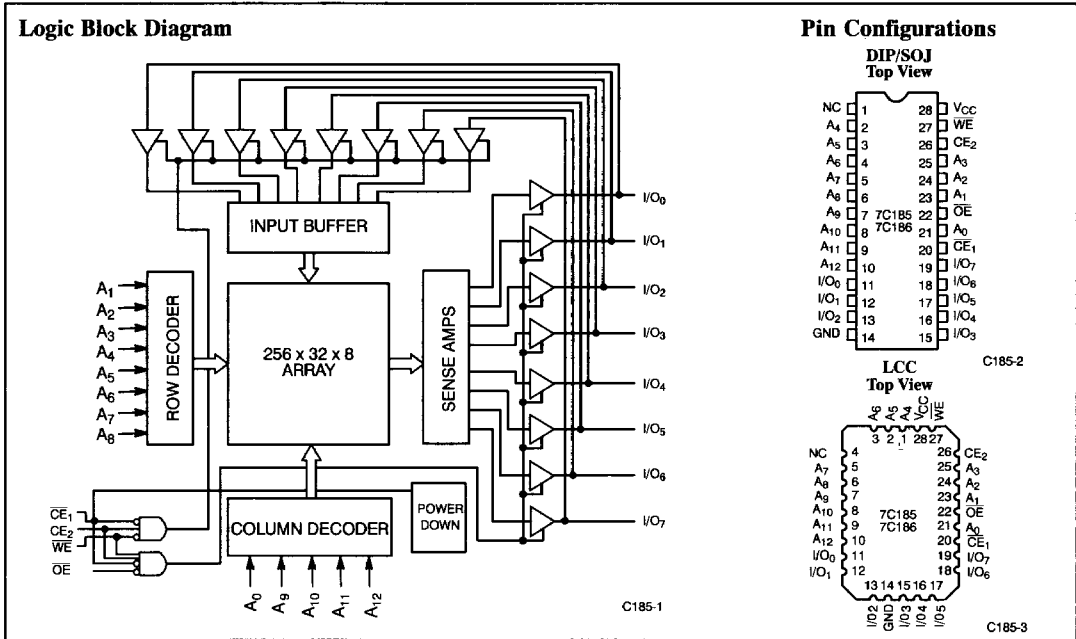

**Selection Guide<sup>[1]</sup>**

	7C185-10	7C185-12	7C185-15	7C185-20 7C186-20	7C185-25 7C186-25	7C185-35 7C186-35	7C185-45 7C186-45	7C185-55 7C186-55
Maximum Access Time (ns)	20	25	35	20	25	35	45	55
Maximum Operating Current (mA)	170	170	160	120	100	100	100	80
Maximum Standby Current (mA)	40/20	40/20	40/20	20/20	20/20	20/20	20/20	20/20

Shaded areas contain advanced information.

**Note:**

1. For military specifications, see the CY7C185A/CY7C186A datasheet.

### Maximum Ratings

(Above which the useful life may be impaired. For user guidelines, not tested.)

Storage Temperature .....	- 65°C to +150°C
Ambient Temperature with Power Applied .....	- 55°C to +125°C
Supply Voltage to Ground Potential .....	- 0.5V to +7.0V
DC Voltage Applied to Outputs in High Z State .....	- 0.5V to +7.0V
DC Input Voltage .....	- 3.0V to +7.0V

Output Current into Outputs (Low) .....	20 mA
Static Discharge Voltage (per MIL-STD-883, Method 3015) .....	>2001V
Latch-Up Current .....	>200 mA

### Operating Range

Range	Ambient Temperature	V <sub>CC</sub>
Commercial	0°C to +70°C	5V ± 10%

### Electrical Characteristics Over the Operating Range

Parameters	Description	Test Conditions	7C185-10		7C185-12		7C185-15		Units
			Min.	Max.	Min.	Max.	Min.	Max.	
V <sub>OH</sub>	Output HIGH Voltage	V <sub>CC</sub> = Min., I <sub>OH</sub> = - 4.0 mA	2.4		2.4		2.4		V
V <sub>OL</sub>	Output LOW Voltage	V <sub>CC</sub> = Min., I <sub>OL</sub> = 8.0 mA		0.4		0.4		0.4	V
V <sub>IH</sub>	Input HIGH Voltage		2.2	V <sub>CC</sub>	2.2	V <sub>CC</sub>	2.2	V <sub>CC</sub>	V
V <sub>IL</sub>	Input LOW Voltage <sup>[2]</sup>		-3.0	0.8	-3.0	0.8	-3.0	0.8	V
I <sub>IX</sub>	Input Load Current	GND ≤ V <sub>I</sub> ≤ V <sub>CC</sub>	-10	+10	-10	+10	-10	+10	μA
I <sub>OZ</sub>	Output Leakage Current	GND ≤ V <sub>I</sub> ≤ V <sub>CC</sub> , Output Disabled	-10	+10	-10	+10	-10	+10	μA
I <sub>OS</sub>	Output Short Circuit Current <sup>[3]</sup>	V <sub>CC</sub> = Max., V <sub>OUT</sub> = GND		-350		-350		-350	mA
I <sub>CC</sub>	V <sub>CC</sub> Operating Supply Current	V <sub>CC</sub> = Max., I <sub>OUT</sub> = 0 mA		170		170		160	mA
I <sub>SB1</sub>	Automatic $\overline{CE}_1$ Power-Down Current	Max. V <sub>CC</sub> , $\overline{CE}_1 \geq V_{IH}$ , Min. Duty Cycle = 100%		40		40		40	mA
I <sub>SB2</sub>	Automatic $\overline{CE}_1$ Power-Down Current	Max. V <sub>CC</sub> , $\overline{CE}_1 \geq V_{CC} - 0.3V$ , V <sub>IN</sub> ≥ V <sub>CC</sub> - 0.3V or V <sub>IN</sub> ≤ 0.3V		20		20		20	mA

Shaded areas contain advanced information.

**Electrical Characteristics** Over the Operating Range (continued)

Parameters	Description	Test Conditions	7C185-20 7C186-20		7C185-25,35,45 7C186-25,35,45		7C185-55 7C186-55		Units
			Min.	Max.	Min.	Max.	Min.	Max.	
V <sub>OH</sub>	Output HIGH Voltage	V <sub>CC</sub> = Min., I <sub>OH</sub> = -4.0 mA	2.4		2.4		2.4		V
V <sub>OL</sub>	Output LOW Voltage	V <sub>CC</sub> = Min., I <sub>OL</sub> = 8.0 mA		0.4		0.4		0.4	V
V <sub>IH</sub>	Input HIGH Voltage		2.2	V <sub>CC</sub>	2.2	V <sub>CC</sub>	2.2	V <sub>CC</sub>	V
V <sub>IL</sub>	Input LOW Voltage <sup>[2]</sup>		-3.0	0.8	-3.0	0.8	-3.0	0.8	V
I <sub>IX</sub>	Input Load Current	GND ≤ V <sub>I</sub> ≤ V <sub>CC</sub>	-10	+10	-10	+10	-10	+10	μA
I <sub>OZ</sub>	Output Leakage Current	GND ≤ V <sub>I</sub> ≤ V <sub>CC</sub> , Output Disabled	-10	+10	-10	+10	-10	+10	μA
I <sub>OS</sub>	Output Short Circuit Current <sup>[3]</sup>	V <sub>CC</sub> = Max., V <sub>OUT</sub> = GND		-300		-300		-300	mA
I <sub>CC</sub>	V <sub>CC</sub> Operating Supply Current	V <sub>CC</sub> = Max., I <sub>OUT</sub> = 0 mA		120		100		80	mA
I <sub>SB1</sub>	Automatic $\overline{CE}_1$ Power-Down Current	Max. V <sub>CC</sub> , $\overline{CE}_1 \geq V_{IH}$ , Min. Duty Cycle = 100%		20		20		20	mA
I <sub>SB2</sub>	Automatic $\overline{CE}_1$ Power-Down Current	Max. V <sub>CC</sub> , $\overline{CE}_1 \geq V_{CC} - 0.3V$ , V <sub>IN</sub> ≥ V <sub>CC</sub> - 0.3V or V <sub>IN</sub> ≤ 0.3V		20		20		20	mA

**Capacitance<sup>[4]</sup>**

Parameters	Description	Test Conditions	Max.	Units
C <sub>IN</sub>	Input Capacitance	T <sub>A</sub> = 25 °C, f = 1 MHz, V <sub>CC</sub> = 5.0V	10	pF
C <sub>OUT</sub>	Output Capacitance		10	pF

**Notes:**

- V<sub>IL</sub> min. = -3.0V for pulse durations less than 30 ns.
- Not more than 1 output should be shorted at one time. Duration of the short circuit should not exceed 30 seconds.
- Tested initially and after any design or process changes that may affect these parameters.

**AC Test Loads and Waveforms**

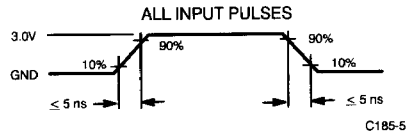
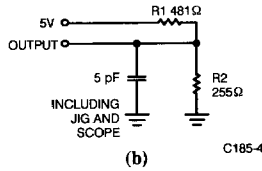
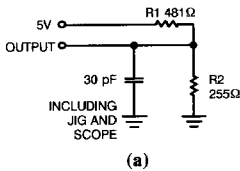

Equivalent to: THÉVENIN EQUIVALENT

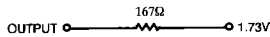

Switching Characteristics Over the Operating Range<sup>[5]</sup>

Parameters	Description	7C185-10		7C185-12		7C185-15		Units
		Min.	Max.	Min.	Max.	Min.	Max.	
<b>READ CYCLE</b>								
t <sub>RC</sub>	Read Cycle Time	10		12		15		ns
t <sub>AA</sub>	Address to Data Valid		10		12		15	ns
t <sub>OHA</sub>	Data Hold from Address Change	3		3		3		ns
t <sub>ACE1</sub>	$\overline{CE}_1$ LOW to Data Valid		10		12		15	ns
t <sub>ACE2</sub>	CE <sub>2</sub> HIGH to Data Valid		10		12		15	ns
t <sub>DOE</sub>	$\overline{OE}$ LOW to Data Valid		5		6		10	ns
t <sub>LZOE</sub>	$\overline{OE}$ LOW to Low Z	0		0		3		ns
t <sub>HZOE</sub>	$\overline{OE}$ HIGH to High Z <sup>[6]</sup>		5		7		8	ns
t <sub>LZCE1</sub>	$\overline{CE}_1$ LOW to Low Z <sup>[7]</sup>	2		3		3		ns
t <sub>LZCE2</sub>	CE <sub>2</sub> HIGH to Low Z	2		3		3		ns
t <sub>HZCE</sub>	$\overline{CE}_1$ HIGH to High Z <sup>[8, 9]</sup> CE <sub>2</sub> LOW to High Z		5		7		8	ns
t <sub>PU</sub>	$\overline{CE}_1$ LOW to Power-Up	0		0		0		ns
t <sub>PD</sub>	$\overline{CE}_1$ HIGH to Power-Down		10		12		15	ns
<b>WRITE CYCLE<sup>[8]</sup></b>								
t <sub>WC</sub>	Write Cycle Time	10		12		15		ns
t <sub>SCE1</sub>	$\overline{CE}_1$ LOW to Write End	8		8		12		ns
t <sub>SCE2</sub>	CE <sub>2</sub> HIGH to Write End	8		8		12		ns
t <sub>AW</sub>	Address Set-Up to Write End	8		9		12		ns
t <sub>HA</sub>	Address Hold from Write End	0		0		0		ns
t <sub>SA</sub>	Address Set-Up to Write Start	0		0		0		ns
t <sub>PWE</sub>	$\overline{WE}$ Pulse Width	8		8		12		ns
t <sub>SD</sub>	Data Set-Up to Write End	5		6		10		ns
t <sub>HD</sub>	Data Hold from Write End	0		0		0		ns
t <sub>HZWE</sub>	$\overline{WE}$ LOW to High Z <sup>[8]</sup>		6		6		7	ns
t <sub>LZWE</sub>	$\overline{WE}$ HIGH to Low Z	2		3		3		ns

Shaded areas contain advanced information.

Notes:

- Test conditions assume signal transition time of 5 ns or less, timing reference levels of 1.5V<sub>I</sub>, input pulse levels of 0 to 3.0V<sub>I</sub>, and output loading of the specified I<sub>OL</sub>/I<sub>OH</sub> and 30-pF load capacitance.
- t<sub>HZOE</sub>, t<sub>HZCE</sub>, and t<sub>HZWE</sub> are specified with C<sub>L</sub> = 5 pF as in part (b) of AC Test Loads. Transition is measured ±500 mV from steady state voltage.
- At any given temperature and voltage condition, t<sub>HZCE</sub> is less than t<sub>LZCE</sub> for any given device.
- The internal write time of the memory is defined by the overlap of  $\overline{CE}_1$  LOW, CE<sub>2</sub> HIGH, and  $\overline{WE}$  LOW. Both signals must be LOW to initiate a write and either signal can terminate a write by going HIGH. The data input set-up and hold timing should be referenced to the rising edge of the signal that terminates the write.

Switching Characteristics Over the Operating Range<sup>[5]</sup>(continued)

Parameters	Description	7C185-20 7C186-20		7C185-25 7C186-25		7C185-35 7C186-35		7C185-45 7C186-45		7C185-55 7C186-55		Units
		Min.	Max.	Min.	Max.	Min.	Max.	Min.	Max.	Min.	Max.	
<b>READ CYCLE</b>												
t <sub>RC</sub>	Read Cycle Time	20		25		35		45		55		ns
t <sub>AA</sub>	Address to Data Valid		20		25		35		45		55	ns
t <sub>OH A</sub>	Data Hold from Address Change	5		5		5		5		5		ns
t <sub>ACE1</sub>	$\overline{CE}_1$ LOW to Data Valid		20		25		35		45		55	ns
t <sub>ACE2</sub>	CE <sub>2</sub> HIGH to Data Valid		20		25		25		30		40	ns
t <sub>DOE</sub>	$\overline{OE}$ LOW to Data Valid		10		12		15		20		25	ns
t <sub>LZOE</sub>	$\overline{OE}$ LOW to Low Z	3		3		3		3		3		ns
t <sub>HZOE</sub>	$\overline{OE}$ HIGH to High Z <sup>[6]</sup>		8		10		12		15		20	ns
t <sub>LZCE1</sub>	$\overline{CE}_1$ LOW to Low Z <sup>[7]</sup>	5		5		5		5		5		ns
t <sub>LZCE2</sub>	CE <sub>2</sub> HIGH to Low Z	3		3		3		3		3		ns
t <sub>HZCE</sub>	$\overline{CE}_1$ HIGH to High Z <sup>[8,9]</sup> CE <sub>2</sub> LOW to High Z		8		10		15		15		20	ns
t <sub>PU</sub>	$\overline{CE}_1$ LOW to Power-Up	0		0		0		0		0		ns
t <sub>PD</sub>	$\overline{CE}_1$ HIGH to Power-Down		20		20		20		25		25	ns
<b>WRITE CYCLE<sup>[8]</sup></b>												
t <sub>WC</sub>	Write Cycle Time	20		20		25		40		50		ns
t <sub>SCE1</sub>	$\overline{CE}_1$ LOW to Write End	15		20		25		30		40		ns
t <sub>SCE2</sub>	CE <sub>2</sub> HIGH to Write End	15		20		20		25		30		ns
t <sub>AW</sub>	Address Set-Up to Write End	15		20		25		30		40		ns
t <sub>HA</sub>	Address Hold from Write End	0		0		0		0		0		ns
t <sub>SA</sub>	Address Set-Up to Write Start	0		0		0		0		0		ns
t <sub>PWE</sub>	$\overline{WE}$ Pulse Width	15		15		20		20		25		ns
t <sub>SD</sub>	Data Set-Up to Write End	10		10		15		15		25		ns
t <sub>HD</sub>	Data Hold from Write End	0		0		0		0		0		ns
t <sub>HZWE</sub>	$\overline{WE}$ LOW to High Z <sup>[8]</sup>		7		7		10		15		20	ns
t <sub>LZWE</sub>	$\overline{WE}$ HIGH to Low Z	5		5		5		5		5		ns

## Switching Waveforms

Read Cycle No. 1<sup>[9, 10]</sup>

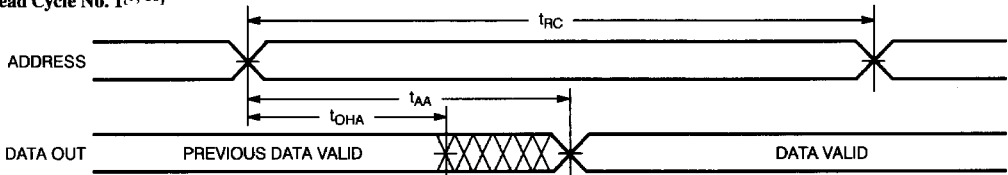

C185-6

Read Cycle No. 2<sup>[11, 12]</sup>

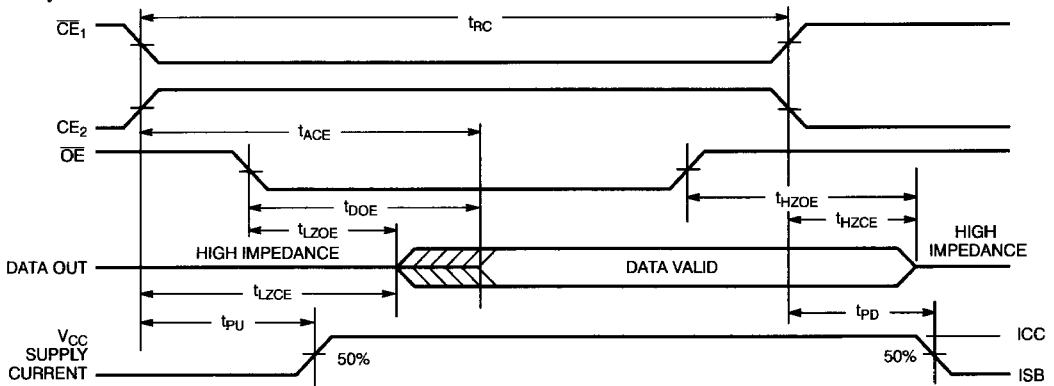

C185-7

Write Cycle No. 1 (WE Controlled)<sup>[10, 12]</sup>

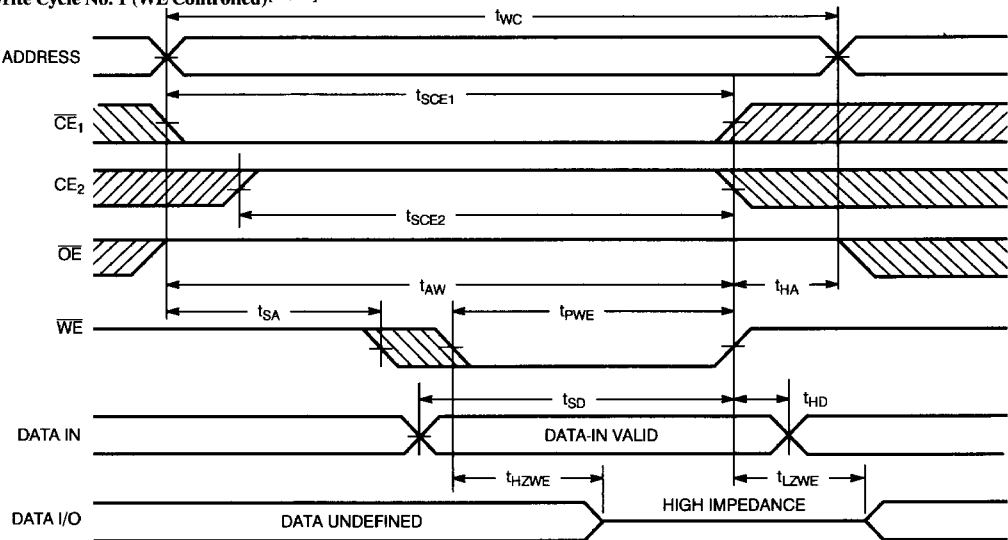

C185-8

**Notes:**

9. Device is continuously selected.  $\overline{OE}, \overline{CE} = V_{IL}$ ,  $CE_2 = V_{IH}$ .  
 10. Address valid prior to or coincident with  $\overline{CE}$  transition LOW.

11.  $\overline{WE}$  is HIGH for read cycle.  
 12. Data I/O is high impedance if  $\overline{OE} = V_{IH}$ .

**Switching Waveforms (continued)**

**Write Cycle No. 2 (CE Controlled)** [10, 12, 13]

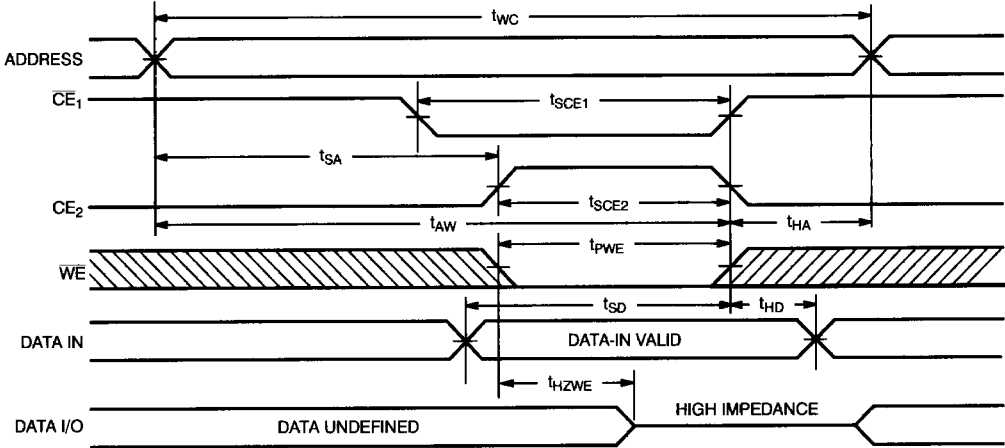

C185-9

**Note:**

13. If  $\overline{CE}$  goes HIGH simultaneously with  $\overline{WE}$  HIGH, the output remains in a high-impedance state.

**Typical DC and AC Characteristics**

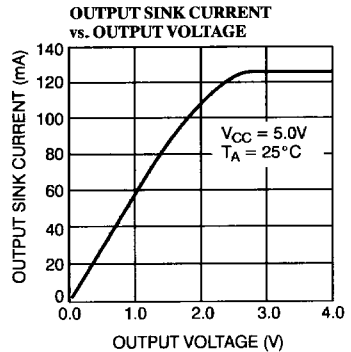
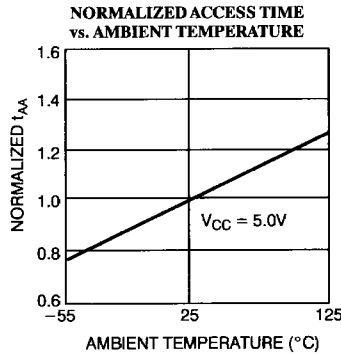
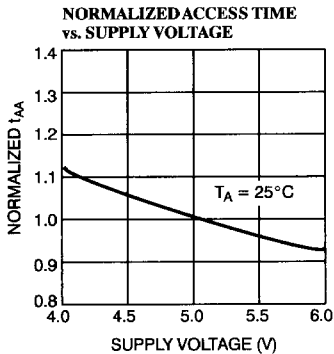
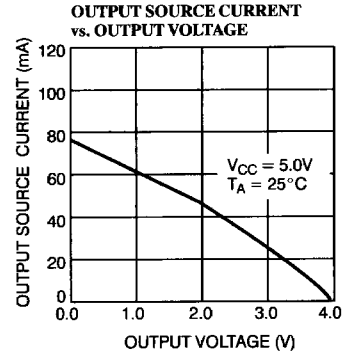
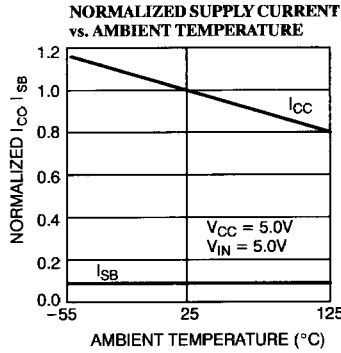
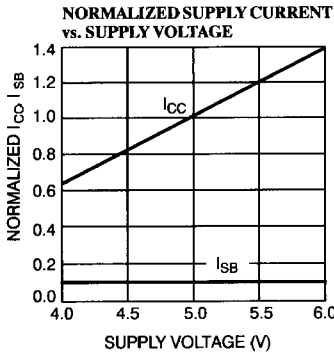

Typical DC and AC Characteristics (continued)

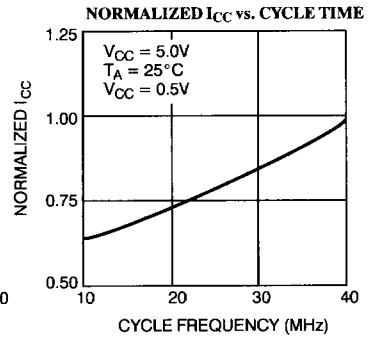
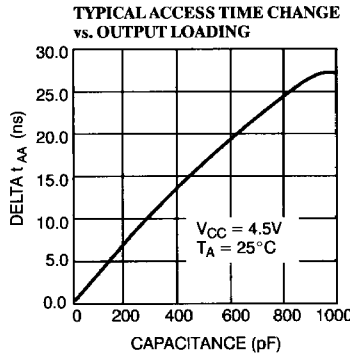
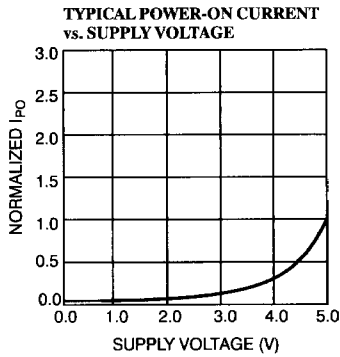

Truth Table

$CE_1$	$CE_2$	WE	OE	Inputs/Outputs	Mode
H	X	X	X	High Z	Deselect/Power-Down
X	L	X	X	High Z	Deselect
L	H	H	L	Data Out	Read
L	H	L	X	Data In	Write
L	H	H	H	High Z	Deselect

Address Designators

Address Name	Address Function	Pin Number
A4	X3	2
A5	X4	3
A6	X5	4
A7	X6	5
A8	X7	6
A9	Y1	7
A10	Y4	8
A11	Y3	9
A12	Y0	10
A0	Y2	21
A1	X0	23
A2	X1	24
A3	X2	25



**Ordering Information**

Speed (ns)	Ordering Code	Package Type	Operating Range
10	CY7C185-10DC	D22	Commercial
	CY7C185-10PC	P21	
	CY7C185-10VC	V21	
12	CY7C185-12DC	D22	Commercial
	CY7C185-12PC	P21	
	CY7C185-12VC	V21	
15	CY7C185-15DC	D22	Commercial
	CY7C185-15PC	P21	
	CY7C185-15VC	V21	
20	CY7C185-20DC	D22	Commercial
	CY7C185-20LC	L54	
	CY7C185-20PC	P21	
	CY7C185-20VC	V21	
25	CY7C185-25DC	D22	Commercial
	CY7C185-25LC	L54	
	CY7C185-25PC	P21	
	CY7C185-25VC	V21	
35	CY7C185-35DC	D22	Commercial
	CY7C185-35LC	L54	
	CY7C185-35PC	P21	
	CY7C185-35VC	V21	
45	CY7C185-45DC	D22	Commercial
	CY7C185-45LC	L54	
	CY7C185-45PC	P21	
	CY7C185-45VC	V21	
55	CY7C185-55DC	D22	Commercial
	CY7C185-55LC	L54	
	CY7C185-55PC	P21	
	CY7C185-55VC	V21	

Shaded areas contain advanced information.

Document #: 38-00037-G

Speed (ns)	Ordering Code	Package Type	Operating Range
20	CY7C186-20DC	D16	Commercial
	CY7C186-20PC	P15	
25	CY7C186-25DC	D16	Commercial
	CY7C186-25PC	P15	
35	CY7C186-35DC	D16	Commercial
	CY7C186-35PC	P15	
45	CY7C186-45DC	D16	Commercial
	CY7C186-45PC	P15	
55	CY7C186-55DC	D16	Commercial
	CY7C186-55PC	P15	