

## Features

- Very high speed: 45 ns
- Temperature ranges
  - Industrial: -40 °C to +85 °C
  - Automotive-A: -40 °C to +85 °C
- Wide voltage range: 2.20 V to 3.60 V
- Pin compatible with CY62146DV30
- Ultra low standby power
  - Typical standby current: 1 μA
  - Maximum standby current: 7 μA
- Ultra low active power
  - Typical active current: 2 mA at f = 1 MHz
- Easy memory expansion with  $\overline{CE}$  and  $\overline{OE}$  features
- Automatic power down when deselected
- Complementary metal oxide semiconductor (CMOS) for optimum speed and power
- Available in a Pb-free 48-ball very fine ball grid array (VFBGA) and 44-pin TSOP II Packages

## Functional Description

The CY62146EV30 is a high performance CMOS static RAM organized as 256K words by 16 bits. This device features an

advanced circuit design designed to provide an ultra low active current. Ultra low active current is ideal for providing More Battery Life™ (MoBL®) in portable applications such as cellular telephones. The device also has an automatic power down feature that significantly reduces power consumption by 80 percent when addresses are not toggling. The device can also be put into standby mode reducing power consumption by more than 99 percent when deselected ( $\overline{CE}$  HIGH). The input and output pins ( $I/O_0$  through  $I/O_{15}$ ) are placed in a high impedance state when the device is deselected ( $\overline{CE}$  HIGH), outputs are disabled ( $\overline{OE}$  HIGH), both Byte High Enable and Byte Low Enable are disabled ( $\overline{BHE}$ ,  $\overline{BLE}$  HIGH), or a write operation is in progress ( $\overline{CE}$  LOW and  $\overline{WE}$  LOW).

To write to the device, take Chip Enable ( $\overline{CE}$ ) and Write Enable ( $\overline{WE}$ ) input LOW. If Byte Low Enable ( $\overline{BLE}$ ) is LOW, then data from  $I/O$  pins ( $I/O_0$  through  $I/O_7$ ) is written into the location specified on the address pins ( $A_0$  through  $A_{17}$ ). If Byte High Enable ( $\overline{BHE}$ ) is LOW, then data from the  $I/O$  pins ( $I/O_8$  through  $I/O_{15}$ ) is written into the location specified on the address pins ( $A_0$  through  $A_{17}$ ).

To read from the device, take Chip Enable ( $\overline{CE}$ ) and Output Enable ( $\overline{OE}$ ) LOW while forcing the Write Enable ( $\overline{WE}$ ) HIGH. If Byte Low Enable ( $\overline{BLE}$ ) is LOW, then data from the memory location specified by the address pins appears on  $I/O_0$  to  $I/O_7$ . If Byte High Enable ( $\overline{BHE}$ ) is LOW, then data from memory appears on  $I/O_8$  to  $I/O_{15}$ . See the Truth Table on page 11 for a complete description of read and write modes.

## Logic Block Diagram

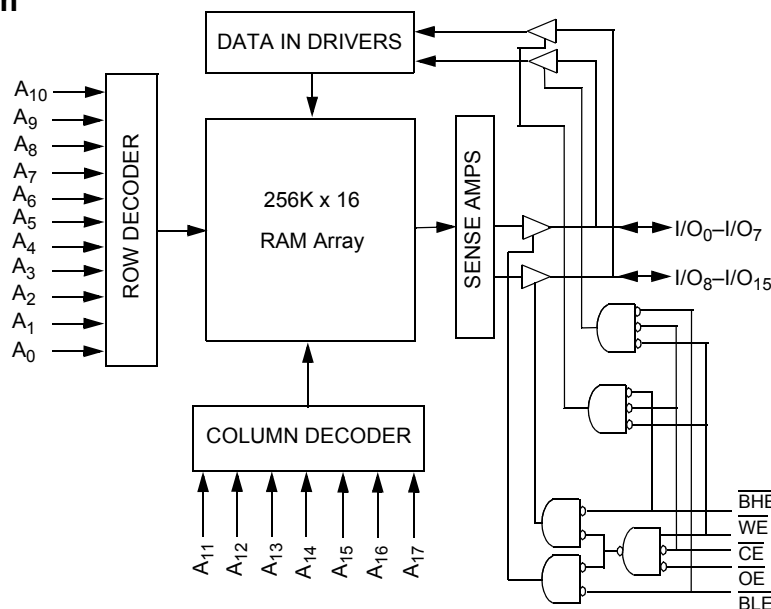

## Contents

<b>Pin Configurations</b> .....	<b>3</b>	<b>Ordering Information</b> .....	<b>12</b>
<b>Product Portfolio</b> .....	<b>3</b>	Ordering Code Definitions .....	12
<b>Maximum Ratings</b> .....	<b>4</b>	<b>Package Diagrams</b> .....	<b>13</b>
<b>Operating Range</b> .....	<b>4</b>	<b>Acronyms</b> .....	<b>15</b>
<b>Electrical Characteristics</b> .....	<b>4</b>	<b>Document Conventions</b> .....	<b>15</b>
<b>Capacitance</b> .....	<b>5</b>	Units of Measure .....	15
<b>Thermal Resistance</b> .....	<b>5</b>	<b>Document History Page</b> .....	<b>16</b>
<b>AC Test Loads and Waveforms</b> .....	<b>5</b>	<b>Sales, Solutions, and Legal Information</b> .....	<b>18</b>
<b>Data Retention Characteristics</b> .....	<b>6</b>	Worldwide Sales and Design Support .....	18
<b>Data Retention Waveform</b> .....	<b>6</b>	Products .....	18
<b>Switching Characteristics</b> .....	<b>7</b>	PSoC® Solutions .....	18
<b>Switching Waveforms</b> .....	<b>8</b>	Cypress Developer Community .....	18
<b>Truth Table</b> .....	<b>11</b>	Technical Support .....	18

### Pin Configurations

Figure 1. 48-ball VFBGA pinout [1, 2]

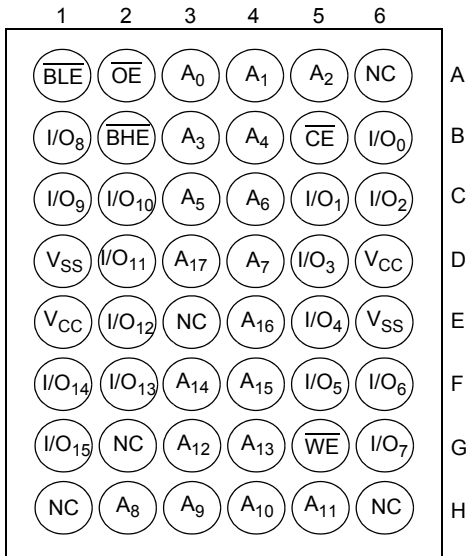
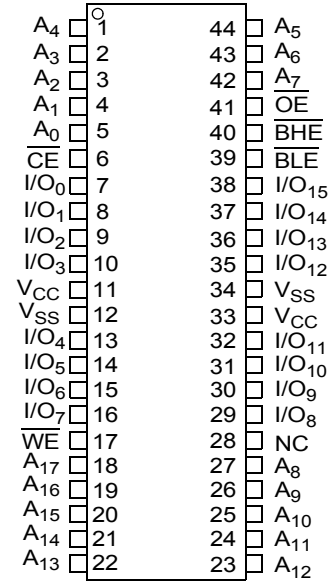

Figure 2. 44-pin TSOP II pinout [1]



### Product Portfolio

Product	Range	V <sub>CC</sub> Range (V)			Speed (ns)	Power Dissipation					
						Operating I <sub>CC</sub> (mA)				Standby I <sub>SB2</sub> (μA)	
		f = 1 MHz		f = f <sub>max</sub>							
Min	Typ [3]	Max	Typ [3]	Max	Typ [3]	Max	Typ [3]	Max			
CY62146EV30LL	Industrial / Automotive-A	2.2	3.0	3.6	45	2	2.5	15	20	1	7

**Notes**

1. NC pins are not connected on the die.
2. Pins H1, G2, and H6 in the BGA package are address expansion pins for 8 Mb, 16 Mb and 32 Mb, respectively.
3. Typical values are included for reference only and are not guaranteed or tested. Typical values are measured at V<sub>CC</sub> = V<sub>CC(typ)</sub>, T<sub>A</sub> = 25 °C.

## Maximum Ratings

Exceeding the maximum ratings may impair the useful life of the device. These user guidelines are not tested.

Storage temperature .....	-65 °C to + 150 °C
Ambient temperature with power applied .....	-55 °C to + 125 °C
Supply voltage to ground potential .....	-0.3 V to + 3.9 V ( $V_{CCmax} + 0.3$ V)
DC voltage applied to outputs in High-Z state <sup>[4, 5]</sup> .....	-0.3 V to 3.9 V ( $V_{CCmax} + 0.3$ V)

DC input voltage <sup>[4, 5]</sup> .....	-0.3 V to 3.9 V ( $V_{CCmax} + 0.3$ V)
Output current into outputs (LOW) .....	20 mA
Static Discharge Voltage (per MIL-STD-883, Method 3015) .....	>2001 V
Latch-up Current .....	>200 mA

## Operating Range

Device	Range	Ambient Temperature	$V_{CC}$ <sup>[6]</sup>
CY62146EV30	Industrial / Automotive-A	-40 °C to +85 °C	2.2 V to 3.6 V

## Electrical Characteristics

Over the Operating Range

Parameter	Description	Test Conditions	45 ns (Ind <sup>!</sup> /Auto-A)			Unit
			Min	Typ <sup>[7]</sup>	Max	
$V_{OH}$	Output high voltage	$I_{OH} = -0.1$ mA	2.0	-	-	V
		$I_{OH} = -1.0$ mA, $V_{CC} \geq 2.70$ V	2.4	-	-	V
$V_{OL}$	Output low voltage	$I_{OL} = 0.1$ mA	-	-	0.4	V
		$I_{OL} = 2.1$ mA, $V_{CC} \geq 2.70$ V	-	-	0.4	V
$V_{IH}$	Input high voltage	$V_{CC} = 2.2$ V to 2.7 V	1.8	-	$V_{CC} + 0.3$	V
		$V_{CC} = 2.7$ V to 3.6 V	2.2	-	$V_{CC} + 0.3$	V
$V_{IL}$	Input LOW Voltage	$V_{CC} = 2.2$ V to 2.7 V	-0.3	-	0.6	V
		$V_{CC} = 2.7$ V to 3.6 V	-0.3	-	0.8	V
$I_{IX}$	Input leakage current	$GND \leq V_I \leq V_{CC}$	-1	-	+1	$\mu$ A
$I_{OZ}$	Output leakage current	$GND \leq V_O \leq V_{CC}$ , Output disabled	-1	-	+1	$\mu$ A
$I_{CC}$	$V_{CC}$ operating supply current	$f = f_{max} = 1/t_{RC}$	-	15	20	mA
		$f = 1$ MHz		2	2.5	
$I_{SB1}$	Automatic CE power down current – CMOS inputs	$V_{CC} = V_{CC(max)}$ , $I_{OUT} = 0$ mA CMOS levels	-	1	7	$\mu$ A
		$CE > V_{CC} - 0.2$ V, $V_{IN} > V_{CC} - 0.2$ V or $V_{IN} < 0.2$ V, $f = f_{max}$ (Address and data only), $f = 0$ (OE, BHE, BLE and WE), $V_{CC} = 3.60$ V				
$I_{SB2}$ <sup>[8]</sup>	Automatic CE power down current – CMOS inputs	$CE \geq V_{CC} - 0.2$ V, $V_{IN} \geq V_{CC} - 0.2$ V or $V_{IN} \leq 0.2$ V, $f = 0$ , $V_{CC} = 3.60$ V	-	1	7	$\mu$ A

### Notes

- $V_{IL(min)}$  = -2.0 V for pulse durations less than 20 ns.
- $V_{IH(max)}$  =  $V_{CC} + 0.75$  V for pulse durations less than 20 ns.
- Full device AC operation assumes a minimum of 100  $\mu$ s ramp time from 0 to  $V_{CC(min)}$  and 200  $\mu$ s wait time after  $V_{CC}$  stabilization.
- Typical values are included for reference only and are not guaranteed or tested. Typical values are measured at  $V_{CC} = V_{CC(typ)}$ ,  $T_A = 25$  °C.
- Chip enable (CE) and byte enables (BHE and BLE) need to be tied to CMOS levels to meet the  $I_{SB1} / I_{SB2} / I_{CCDR}$  spec. Other inputs can be left floating.

### Capacitance

Parameter <sup>[9]</sup>	Description	Test Conditions	Max	Unit
C <sub>IN</sub>	Input capacitance	T <sub>A</sub> = 25 °C, f = 1 MHz, V <sub>CC</sub> = V <sub>CC(typ)</sub>	10	pF
C <sub>OUT</sub>	Output capacitance		10	pF

### Thermal Resistance

Parameter <sup>[9]</sup>	Description	Test Conditions	VFBGA	TSOP II	Unit
Θ <sub>JA</sub>	Thermal resistance (junction to ambient)	Still air, soldered on a 3 × 4.5 inch, two-layer printed circuit board	75	77	°C/W
Θ <sub>JC</sub>	Thermal resistance (junction to case)		10	13	°C/W

### AC Test Loads and Waveforms

Figure 3. AC Test Loads and Waveforms

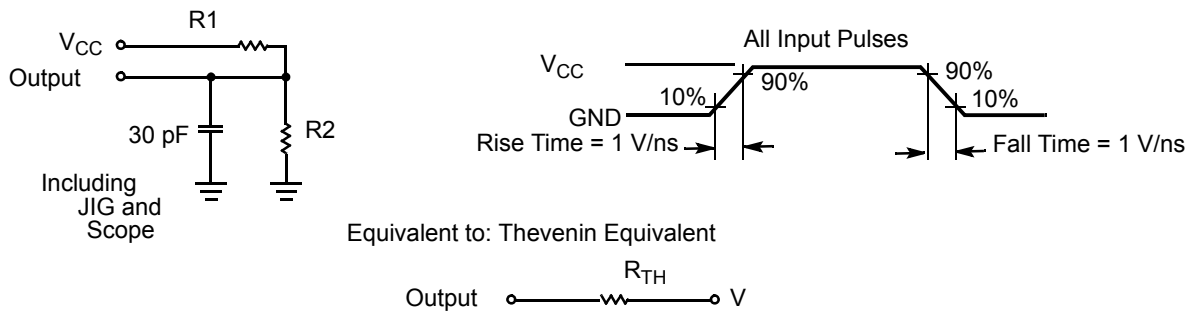

Parameters	2.50 V	3.0 V	Unit
R1	16667	1103	Ω
R2	15385	1554	Ω
R <sub>TH</sub>	8000	645	Ω
V <sub>TH</sub>	1.20	1.75	V

**Note**

9. Tested initially and after any design or process changes that may affect these parameters.

## Data Retention Characteristics

Over the Operating Range

Parameter	Description	Conditions	Min	Typ <sup>[10]</sup>	Max	Unit
V <sub>DR</sub>	V <sub>CC</sub> for data retention		1.5	–	–	V
I <sub>CCDR</sub> <sup>[11]</sup>	Data retention current	V <sub>CC</sub> = 1.5 V, CE ≥ V <sub>CC</sub> – 0.2 V, V <sub>IN</sub> ≥ V <sub>CC</sub> – 0.2 V or V <sub>IN</sub> ≤ 0.2 V	–	0.8	7	μA
t <sub>CDR</sub> <sup>[12]</sup>	Chip deselect to data retention time	–	0	–	–	ns
t <sub>R</sub> <sup>[13]</sup>	Operation recovery time	–	45	–	–	ns

## Data Retention Waveform

Figure 4. Data Retention Waveform

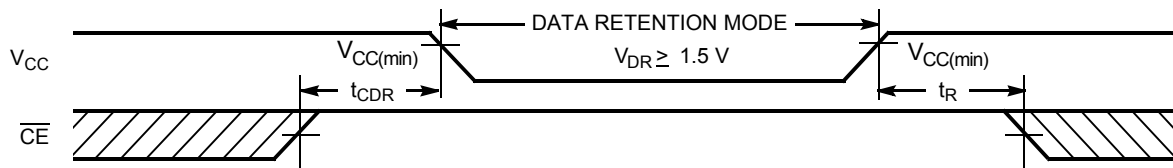

### Notes

10. Typical values are included for reference only and are not guaranteed or tested. Typical values are measured at V<sub>CC</sub> = V<sub>CC(typ)</sub>, T<sub>A</sub> = 25 °C.
11. Chip enable (CE) and byte enables (BHE and BLE) need to be tied to CMOS levels to meet the I<sub>SB1</sub>/I<sub>SB2</sub>/I<sub>CCDR</sub> spec. Other inputs can be left floating.
12. Tested initially and after any design or process changes that may affect these parameters.
13. Full device operation requires linear V<sub>CC</sub> ramp from V<sub>DR</sub> to V<sub>CC(min)</sub> ≥ 100 μs or stable at V<sub>CC(min)</sub> ≥ 100 μs.

## Switching Characteristics

Over the Operating Range

Parameter [14, 15]	Description	45 ns (Industrial / Automotive-A)		Unit
		Min	Max	
<b>Read Cycle</b>				
$t_{RC}$	Read cycle time	45	–	ns
$t_{AA}$	Address to data valid	–	45	ns
$t_{OHA}$	Data hold from address change	10	–	ns
$t_{ACE}$	$\overline{CE}$ LOW to data valid	–	45	ns
$t_{DOE}$	$\overline{OE}$ LOW to data valid	–	22	ns
$t_{LZOE}$	$\overline{OE}$ LOW to Low-Z [16]	5	–	ns
$t_{HZOE}$	$\overline{OE}$ HIGH to High-Z [16, 17]	–	18	ns
$t_{LZCE}$	$\overline{CE}$ LOW to Low-Z [16]	10	–	ns
$t_{HZCE}$	$\overline{CE}$ HIGH to High-Z [16, 17]	–	18	ns
$t_{PU}$	$\overline{CE}$ LOW to power up	0	–	ns
$t_{PD}$	$\overline{CE}$ HIGH to power down	–	45	ns
$t_{DBE}$	$\overline{BLE} / \overline{BHE}$ LOW to data valid	–	22	ns
$t_{LZBE}$	$\overline{BLE} / \overline{BHE}$ LOW to Low-Z [16]	5	–	ns
$t_{HZBE}$	$\overline{BLE} / \overline{BHE}$ HIGH to High-Z [16, 17]	–	18	ns
<b>Write Cycle [18]</b>				
$t_{WC}$	Write cycle time	45	–	ns
$t_{SCE}$	$\overline{CE}$ LOW to write end	35	–	ns
$t_{AW}$	Address setup to write end	35	–	ns
$t_{HA}$	Address hold from write end	0	–	ns
$t_{SA}$	Address setup to write start	0	–	ns
$t_{PWE}$	$\overline{WE}$ pulse width	35	–	ns
$t_{BW}$	$\overline{BLE} / \overline{BHE}$ LOW to write end	35	–	ns
$t_{SD}$	Data setup to write end	25	–	ns
$t_{HD}$	Data hold from write end	0	–	ns
$t_{HZWE}$	$\overline{WE}$ LOW to High-Z [16, 17]	–	18	ns
$t_{LZWE}$	$\overline{WE}$ HIGH to Low-Z [16]	10	–	ns

### Notes

14. Test conditions for all parameters other than tri-state parameters assume signal transition time of 3 ns (1 V/ns) or less, timing reference levels of  $V_{CC(typ)}/2$ , input pulse levels of 0 to  $V_{CC(typ)}$ , and output loading of the specified  $I_{OL}/I_{OH}$  as shown in the [Figure 3 on page 5](#).
15. In an earlier revision of this device, under a specific application condition, READ and WRITE operations were limited to switching of the byte enable and/or chip enable signals as described in the Application Notes [AN13842](#) and [AN66311](#). However, the issue has been fixed and in production now, and hence, these Application Notes are no longer applicable. They are available for download on our website as they contain information on the date code of the parts, beyond which the fix has been in production.
16. At any given temperature and voltage condition,  $t_{HZCE}$  is less than  $t_{LZCE}$ ,  $t_{HZBE}$  is less than  $t_{LZBE}$ ,  $t_{HZOE}$  is less than  $t_{LZOE}$ , and  $t_{HZWE}$  is less than  $t_{LZWE}$  for any given device.
17.  $t_{HZOE}$ ,  $t_{HZCE}$ ,  $t_{HZBE}$ , and  $t_{HZWE}$  transitions are measured when the outputs enter a high impedance state.
18. The internal write time of the memory is defined by the overlap of  $\overline{WE}$ ,  $\overline{CE} = V_{IL}$ ,  $\overline{BHE}$  and/or  $\overline{BLE} = V_{IL}$ . All signals must be ACTIVE to initiate a write and any of these signals can terminate a write by going INACTIVE. The data input setup and hold timing must be referenced to the edge of the signal that terminates the write.

## Switching Waveforms

Figure 5. Read Cycle 1 (Address Transition Controlled) [19, 20]

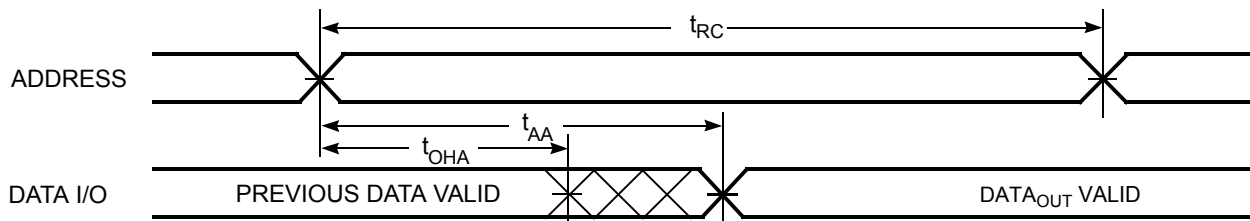
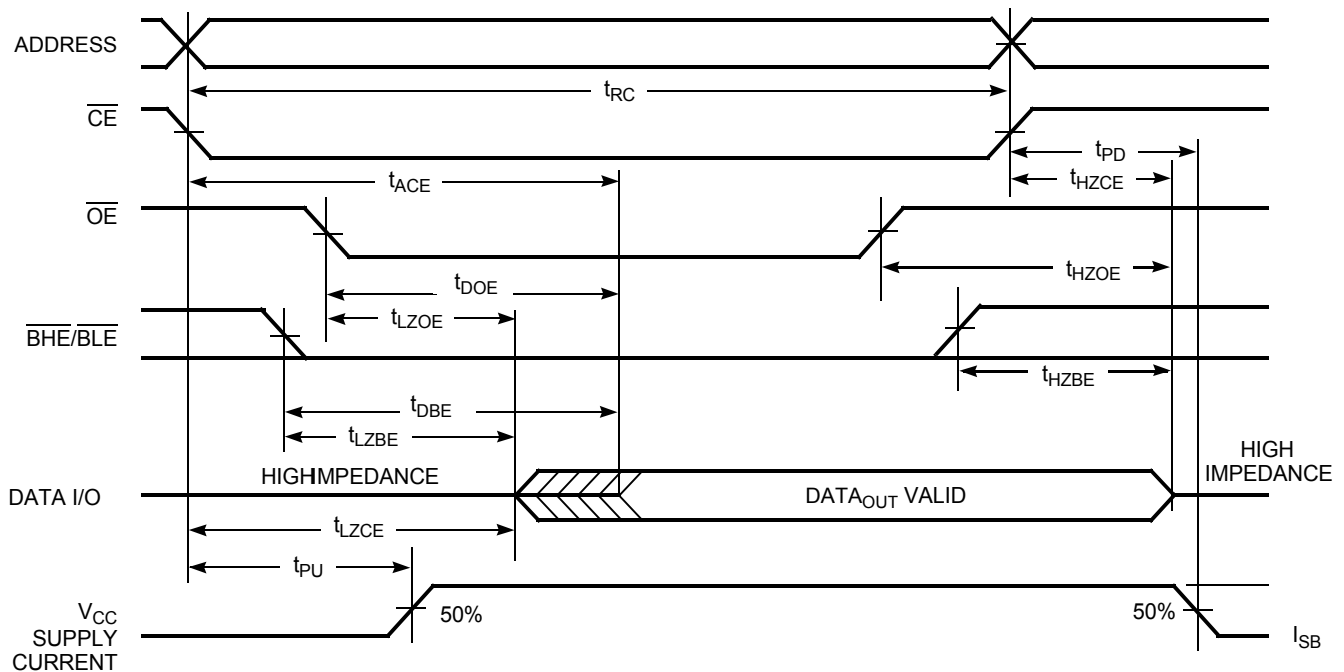

Figure 6. Read Cycle No. 2 ( $\overline{OE}$  Controlled) [20, 21]



### Notes

19. The device is continuously selected.  $\overline{OE}$ ,  $\overline{CE} = V_{IL}$ ,  $\overline{BHE}$  and/or  $\overline{BLE} = V_{IL}$ .

20.  $\overline{WE}$  is HIGH for read cycle.

21. Address valid before or similar to  $\overline{CE}$  and  $\overline{BHE}$ ,  $\overline{BLE}$  transition LOW.



Switching Waveforms (continued)

Figure 7. Write Cycle No. 1 ( $\overline{\text{WE}}$  Controlled) [22, 23, 24]

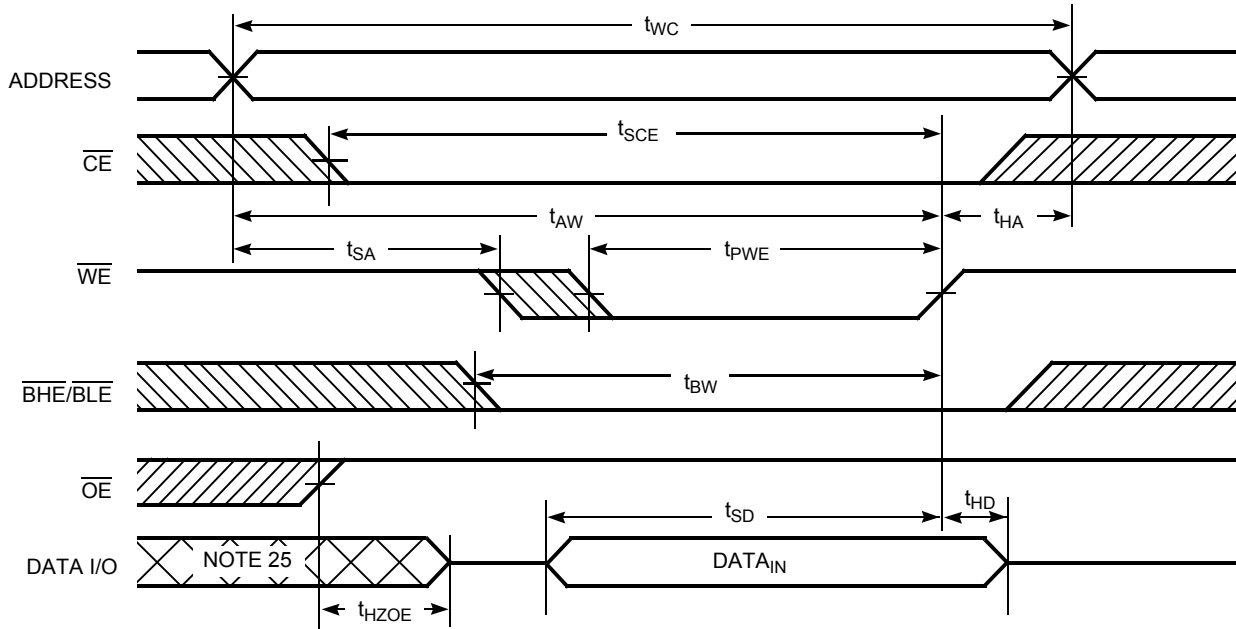
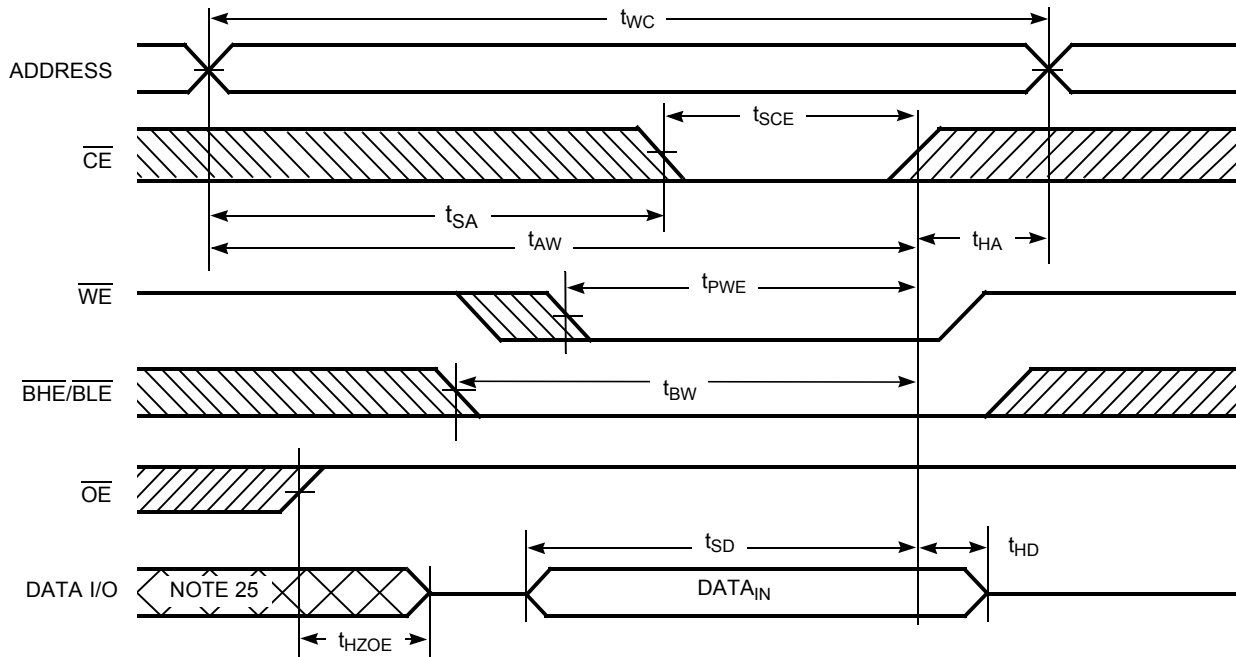

Figure 8. Write Cycle No. 2 ( $\overline{\text{CE}}$  Controlled) [22, 23, 24]



Notes

- 22. The internal write time of the memory is defined by the overlap of  $\overline{\text{WE}}$ ,  $\overline{\text{CE}} = V_{\text{IL}}$ ,  $\overline{\text{BHE}}$  and/or  $\overline{\text{BLE}} = V_{\text{IL}}$ . All signals must be ACTIVE to initiate a write and any of these signals can terminate a write by going INACTIVE. The data input setup and hold timing must be referenced to the edge of the signal that terminates the write.
- 23. Data I/O is high impedance if  $\overline{\text{OE}} = V_{\text{IH}}$ .
- 24. If  $\overline{\text{CE}}$  goes HIGH simultaneously with  $\overline{\text{WE}} = V_{\text{IH}}$ , the output remains in a high impedance state.
- 25. During this period, the I/Os are in output state and input signals must not be applied.

Switching Waveforms (continued)

Figure 9. Write Cycle No. 3 ( $\overline{WE}$  Controlled,  $\overline{OE}$  LOW) [26]

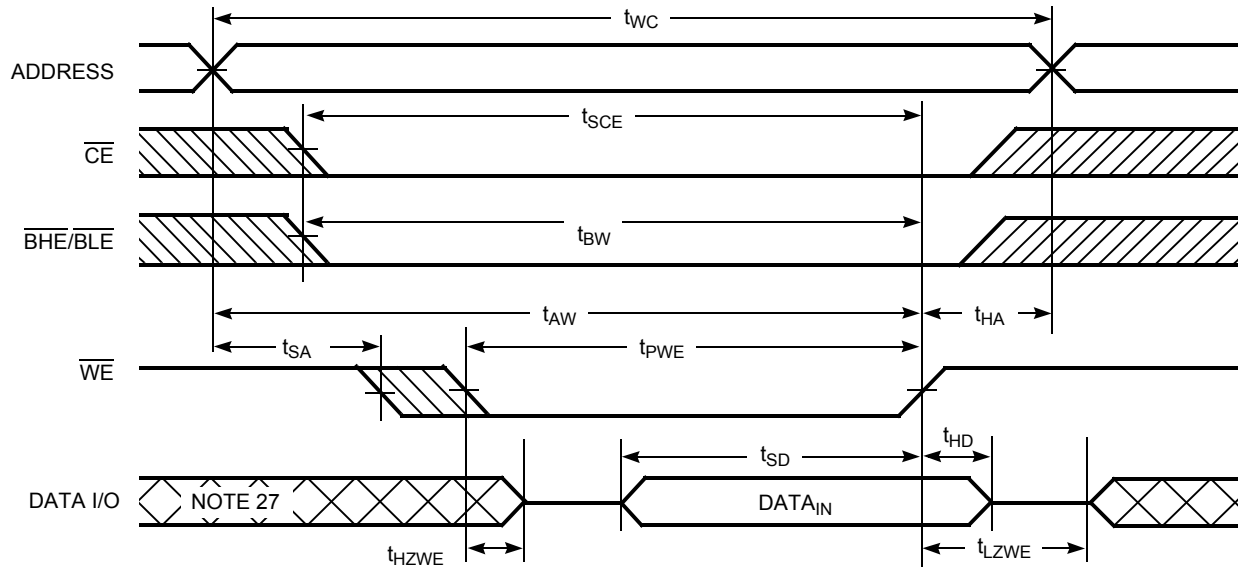
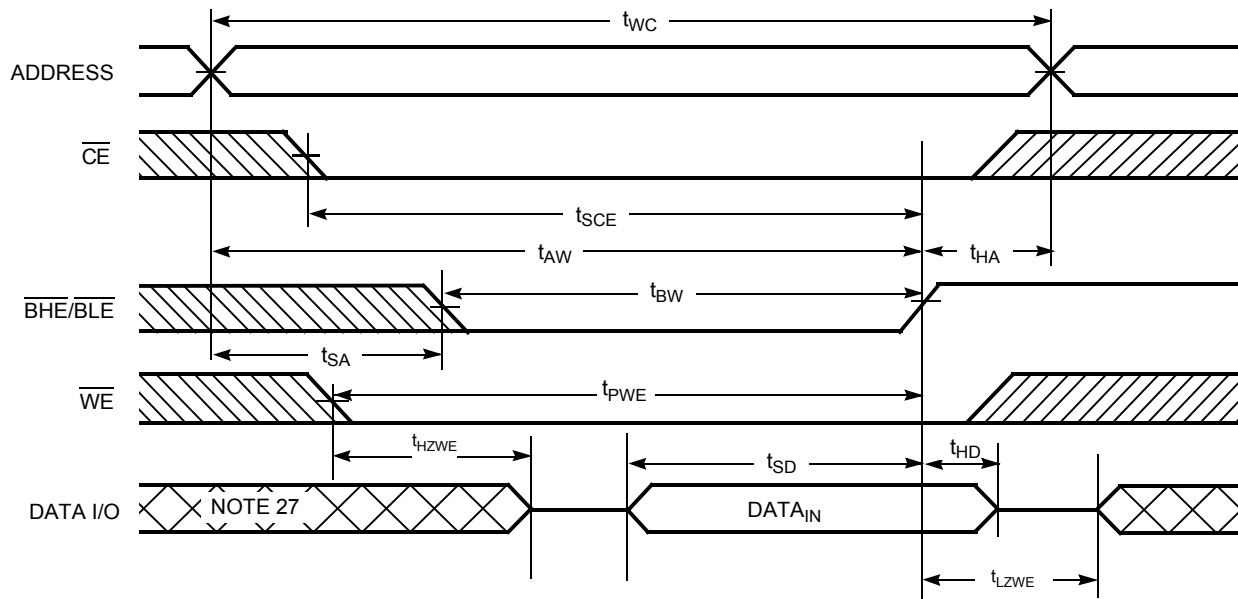

Figure 10. Write Cycle No. 4 ( $\overline{BHE}/\overline{BLE}$  Controlled,  $\overline{OE}$  LOW) [26]



Notes

- 26. If  $\overline{CE}$  goes HIGH simultaneously with  $\overline{WE} = V_{IH}$ , the output remains in a high impedance state.
- 27. During this period, the I/Os are in output state and input signals must not be applied.

**Truth Table**

CE <sup>[28]</sup>	WE	OE	BHE	BLE	Inputs/Outputs	Mode	Power
H	X	X	X	X	High-Z	Deselect/power-down	Standby (I <sub>SB</sub> )
L	X	X	H	H	High-Z	Output disabled	Active (I <sub>CC</sub> )
L	H	L	L	L	Data out (I/O <sub>0</sub> –I/O <sub>15</sub> )	Read	Active (I <sub>CC</sub> )
L	H	L	H	L	Data out (I/O <sub>0</sub> –I/O <sub>7</sub> ); I/O <sub>8</sub> –I/O <sub>15</sub> in High-Z	Read	Active (I <sub>CC</sub> )
L	H	L	L	H	Data out (I/O <sub>8</sub> –I/O <sub>15</sub> ); I/O <sub>0</sub> –I/O <sub>7</sub> in High-Z	Read	Active (I <sub>CC</sub> )
L	H	H	L	L	High-Z	Output disabled	Active (I <sub>CC</sub> )
L	H	H	H	L	High-Z	Output disabled	Active (I <sub>CC</sub> )
L	H	H	L	H	High-Z	Output disabled	Active (I <sub>CC</sub> )
L	L	X	L	L	Data in (I/O <sub>0</sub> –I/O <sub>15</sub> )	Write	Active (I <sub>CC</sub> )
L	L	X	H	L	Data in (I/O <sub>0</sub> –I/O <sub>7</sub> ); I/O <sub>8</sub> –I/O <sub>15</sub> in High-Z	Write	Active (I <sub>CC</sub> )
L	L	X	L	H	Data in (I/O <sub>8</sub> –I/O <sub>15</sub> ); I/O <sub>0</sub> –I/O <sub>7</sub> in High-Z	Write	Active (I <sub>CC</sub> )

**Note**

28. Chip enable must be at CMOS levels (not floating). Intermediate voltage levels on this pin is not permitted.

### Ordering Information

Speed (ns)	Ordering Code	Package Diagram	Package Type	Operating Range
45	CY62146EV30LL-45BVXI	51-85150	48-ball VFBGA (Pb-free)	Industrial
	CY62146EV30LL-45ZSXI	51-85087	44-pin TSOP II (Pb-free)	
	CY62146EV30LL-45ZSXA	51-85087	44-pin TSOP II (Pb-free)	Automotive-A

Please contact your local Cypress sales representative for availability of other parts

### Ordering Code Definitions

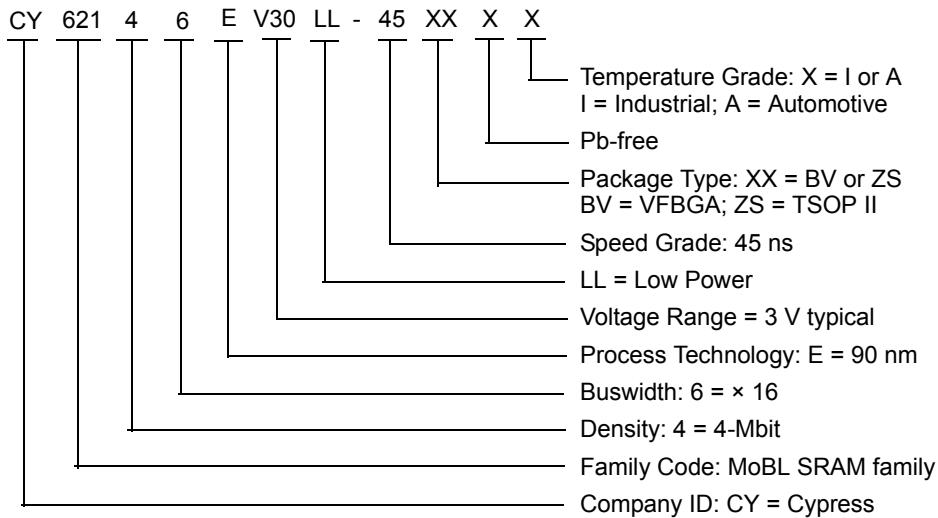

Package Diagrams

Figure 11. 48-ball VFBGA (6 × 8 × 1.0 mm) BV48/BZ48 Package Outline, 51-85150

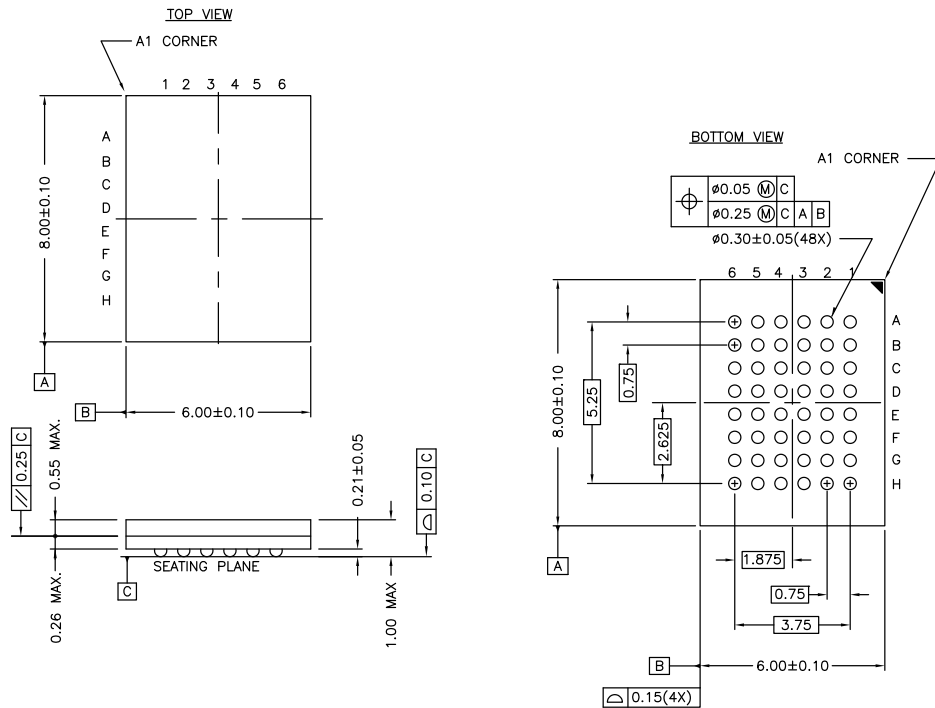

NOTE:  
 PACKAGE WEIGHT: See Cypress Package Material Declaration Datasheet (PMDD) posted on the Cypress web.

51-85150 \*H

Package Diagrams (continued)

Figure 12. 44-pin TSOP Z44-II Package Outline, 51-85087

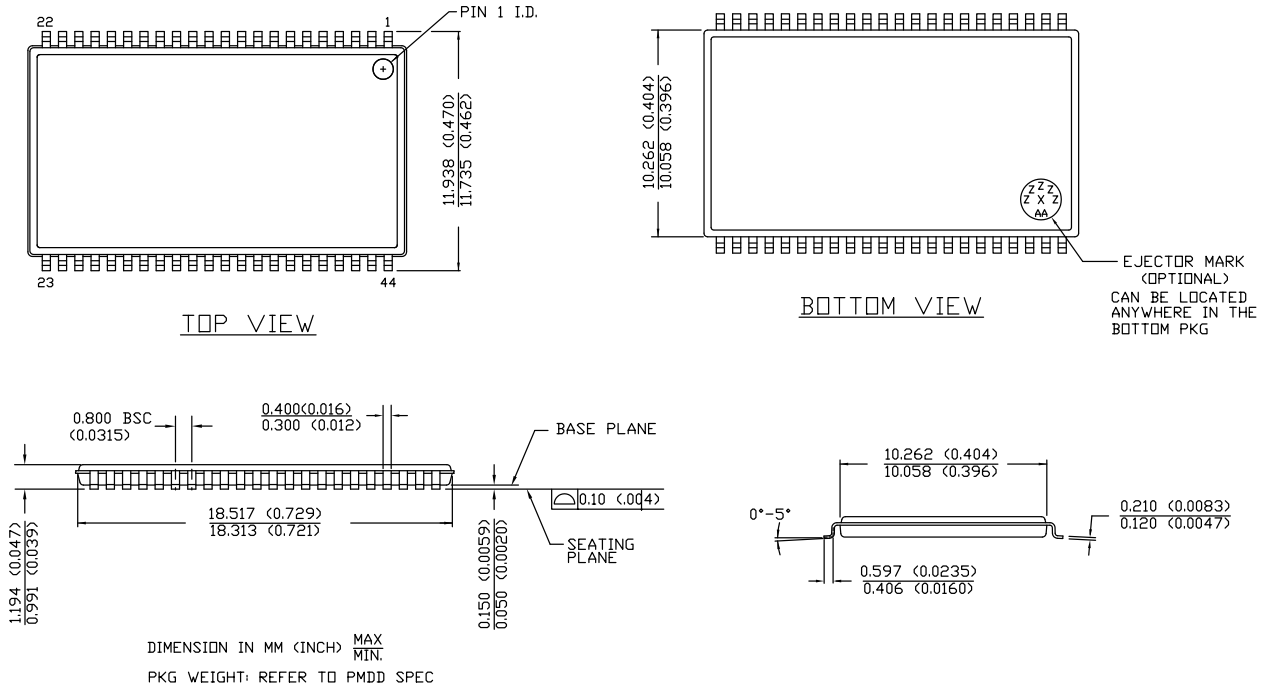

51-85087 \*E

## Acronyms

Acronym	Description
$\overline{\text{BHE}}$	Byte High Enable
$\overline{\text{BLE}}$	Byte Low Enable
CMOS	Complementary Metal Oxide Semiconductor
$\overline{\text{CE}}$	Chip Enable
I/O	Input/Output
$\overline{\text{OE}}$	Output Enable
SRAM	Static Random Access Memory
TSOP	Thin Small Outline Package
VFBGA	Very Fine-Pitch Ball Grid Array
$\overline{\text{WE}}$	Write Enable

## Document Conventions

### Units of Measure

Symbol	Unit of Measure
°C	degree Celsius
MHz	megahertz
μA	microampere
mA	milliampere
ns	nanosecond
Ω	ohm
pF	picofarad
V	volt
W	watt

**Document History Page**

Document Title: CY62146EV30 MoBL <sup>®</sup> , 4-Mbit (256 K × 16) Static RAM Document Number: 38-05567				
Rev.	ECN No.	Orig. of Change	Submission Date	Description of Change
**	223225	AJU	See ECN	New data sheet.
*A	247373	SYT	See ECN	<p>Changed status from Advance Information to Preliminary.            Moved Product Portfolio to Page 2            Changed V<sub>CC</sub> stabilization time in footnote #8 from 100 μs to 200 μs            Removed Footnote #14(t<sub>LZBE</sub>) from Previous revision            Changed I<sub>CCDR</sub> from 2.0 μA to 2.5 μA            Changed typo in Data Retention Characteristics (t<sub>R</sub>) from 100 μs to t<sub>RC</sub> ns            Changed t<sub>OHA</sub> from 6 ns to 10 ns for both 35 ns and 45 ns Speed Bin            Changed t<sub>HZOE</sub>, t<sub>HZBE</sub>, t<sub>HZWE</sub> from 12 to 15 ns for 35 ns Speed Bin and 15 to 18 ns for 45 ns Speed Bin            Changed t<sub>SCE</sub> and t<sub>BW</sub> from 25 to 30 ns for 35 ns Speed Bin and 40 to 35 ns for 45 ns Speed Bin            Changed t<sub>HZCE</sub> from 12 to 18 ns for 35 ns Speed Bin and 15 to 22 ns for 45 ns Speed Bin            Changed t<sub>SD</sub> from 15 to 18 ns for 35 ns Speed Bin and 20 to 22 ns for 45 ns Speed Bin            Changed t<sub>DOE</sub> from 15 to 18 ns for 35 ns Speed Bin            Changed t<sub>DBE</sub> from 15 to 18 ns for 35 ns Speed Bin            Changed Ordering Information to include Pb-Free Packages</p>
*B	414807	ZSD	See ECN	<p>Changed from Preliminary information to Final            Changed the address of Cypress Semiconductor Corporation on Page #1 from "3901 North First Street" to "198 Champion Court"            Removed 35ns Speed Bin            Removed "L" version of CY62146EV30            Changed ball E3 from DNU to NC            Removed the redundant foot note on DNU.            Changed I<sub>CC</sub> (Max) value from 2 mA to 2.5 mA and I<sub>CC</sub> (Typ) value from 1.5 mA to 2 mA at f=1 MHz            Changed I<sub>CC</sub> (Typ) value from 12 mA to 15 mA at f = f<sub>max</sub>            Changed I<sub>SB1</sub> and I<sub>SB2</sub> Typ values from 0.7 μA to 1 μA and Max values from 2.5 μA to 7 μA.            Changed the AC test load capacitance from 50pF to 30pF on Page# 4            Changed I<sub>CCDR</sub> from 2.5 μA to 7 μA.            Added I<sub>CCDR</sub> typical value.            Changed t<sub>LZOE</sub> from 3 ns to 5 ns            Changed t<sub>LZCE</sub> and t<sub>LZWE</sub> from 6 ns to 10 ns            Changed t<sub>LZBE</sub> from 6 ns to 5 ns            Changed t<sub>HZCE</sub> from 22 ns to 18 ns            Changed t<sub>PWE</sub> from 30 ns to 35 ns.            Changed t<sub>SD</sub> from 22 ns to 25 ns.            Updated the package diagram 48-ball VFBGA from *B to *D            Updated the ordering information table and replaced the Package Name column with Package Diagram.</p>
*C	925501	VKN	See ECN	<p>Added footnote #8 related to I<sub>SB2</sub> and I<sub>CCDR</sub>            Added footnote #12 related AC timing parameters</p>
*D	2678796	VKN / PYRS	03/25/2009	Added Automotive-A information
*E	2944332	VKN	06/04/2010	<p>Added <a href="#">Contents</a>            Removed byte enable from footnote #2 in <a href="#">Electrical Characteristics</a>            Added footnote related to chip enable in <a href="#">Truth Table</a>            Updated <a href="#">Package Diagrams</a>            Updated links in <a href="#">Sales, Solutions, and Legal Information</a></p>



**Document History Page** (continued)

Document Title: CY62146EV30 MoBL <sup>®</sup> , 4-Mbit (256 K × 16) Static RAM Document Number: 38-05567				
Rev.	ECN No.	Orig. of Change	Submission Date	Description of Change
*F	3109050	PRAS	12/13/2010	Changed Table Footnotes to Footnotes. Added Ordering Code Definitions.
*G	3302915	RAME	07/14/2011	Updated as per template. Added Units of Measure table. Updated all the notes. Ordering Code Definition updated. Removed the references of AN1064 SRAM system guidelines from the datasheet.
*H	3961126	TAVA	04/10/2013	Updated <a href="#">Package Diagrams</a> : spec 51-85150 – Changed revision from *F to *H. spec 51-85087 – Changed revision from *C to *E.  Completing Sunset Review.
*I	4101995	VINI	08/22/2013	Updated <a href="#">Switching Characteristics</a> : Updated Note 15.  Updated in new template.

## Sales, Solutions, and Legal Information

### Worldwide Sales and Design Support

Cypress maintains a worldwide network of offices, solution centers, manufacturer's representatives, and distributors. To find the office closest to you, visit us at [Cypress Locations](#).

#### Products

<a href="#">Automotive</a>	<a href="#">cypress.com/go/automotive</a>
<a href="#">Clocks &amp; Buffers</a>	<a href="#">cypress.com/go/clocks</a>
<a href="#">Interface</a>	<a href="#">cypress.com/go/interface</a>
<a href="#">Lighting &amp; Power Control</a>	<a href="#">cypress.com/go/powerpsoc</a> <a href="#">cypress.com/go/plc</a>
<a href="#">Memory</a>	<a href="#">cypress.com/go/memory</a>
<a href="#">PSoC</a>	<a href="#">cypress.com/go/psoc</a>
<a href="#">Touch Sensing</a>	<a href="#">cypress.com/go/touch</a>
<a href="#">USB Controllers</a>	<a href="#">cypress.com/go/USB</a>
<a href="#">Wireless/RF</a>	<a href="#">cypress.com/go/wireless</a>

#### PSoC<sup>®</sup> Solutions

[psoc.cypress.com/solutions](#)  
[PSoC 1](#) | [PSoC 3](#) | [PSoC 4](#) | [PSoC 5LP](#)

#### Cypress Developer Community

[Community](#) | [Forums](#) | [Blogs](#) | [Video](#) | [Training](#)

#### Technical Support

[cypress.com/go/support](#)

---

© Cypress Semiconductor Corporation, 2004–2013. The information contained herein is subject to change without notice. Cypress Semiconductor Corporation assumes no responsibility for the use of any circuitry other than circuitry embodied in a Cypress product. Nor does it convey or imply any license under patent or other rights. Cypress products are not warranted nor intended to be used for medical, life support, life saving, critical control or safety applications, unless pursuant to an express written agreement with Cypress. Furthermore, Cypress does not authorize its products for use as critical components in life-support systems where a malfunction or failure may reasonably be expected to result in significant injury to the user. The inclusion of Cypress products in life-support systems application implies that the manufacturer assumes all risk of such use and in doing so indemnifies Cypress against all charges.

Any Source Code (software and/or firmware) is owned by Cypress Semiconductor Corporation (Cypress) and is protected by and subject to worldwide patent protection (United States and foreign), United States copyright laws and international treaty provisions. Cypress hereby grants to licensee a personal, non-exclusive, non-transferable license to copy, use, modify, create derivative works of, and compile the Cypress Source Code and derivative works for the sole purpose of creating custom software and or firmware in support of licensee product to be used only in conjunction with a Cypress integrated circuit as specified in the applicable agreement. Any reproduction, modification, translation, compilation, or representation of this Source Code except as specified above is prohibited without the express written permission of Cypress.

Disclaimer: CYPRESS MAKES NO WARRANTY OF ANY KIND, EXPRESS OR IMPLIED, WITH REGARD TO THIS MATERIAL, INCLUDING, BUT NOT LIMITED TO, THE IMPLIED WARRANTIES OF MERCHANTABILITY AND FITNESS FOR A PARTICULAR PURPOSE. Cypress reserves the right to make changes without further notice to the materials described herein. Cypress does not assume any liability arising out of the application or use of any product or circuit described herein. Cypress does not authorize its products for use as critical components in life-support systems where a malfunction or failure may reasonably be expected to result in significant injury to the user. The inclusion of Cypress' product in a life-support systems application implies that the manufacturer assumes all risk of such use and in doing so indemnifies Cypress against all charges.

Use may be limited by and subject to the applicable Cypress software license agreement.