

CHT-PLUTO-B1220 Preliminary Datasheet

Version: 1.1

High Temperature 1200V/20A Dual SiC MOSFET Module

General description

CHT-PLUTO-B1220 is a high temperature 1200V/20A Dual Silicon Carbide MOSFET in a single hermetic module. It is suitable to implement a power half bridge for applications such as DC-DC converters or motor drives in high temperature environments. The two independent switches can be used in parallel to deliver a total of 40A. This product is guaranteed for normal operation on the full range -55°C to +210°C (Tj). Each MOSFET has a breakdown voltage in excess of 1200V and is capable of switching current up to 20A. They have an on-resistance of 90mΩ at 25°C and 200mΩ at 210°C at VGS=20V. Each MOSFET has an intrinsic body diode.

Benefits

- High power density converters (support of high-frequency switching and reduced cooling)
- Extended lifetime and high reliability
- Harsh environments and high temperature power converters
- Seamless driving with HADES® gate driver solutions

Applications

- DC motor drives and actuator control
- DC-DC converters

Features (per switch)

- Specified from -55 to +210°C (Tj)
- V_{DS} Max: 1200V
- Max Continuous Current:
 - 20A @ Tc≤160°C
 - 17A @ Tc=175°C
- Max Pulsed Current: 25A
- Typical On-resistance:
 - R_{DSon}= 40 mΩ @ Tj=25°C
 - R_{DSon}= 120 mΩ @ Tj=210°C
- High Speed Switching
- Voltage control: V_{GS}=-5V/20V
- Low gate charge: Q_{GS}: 22nC
- Hermetic package with isolated case

Functional Block Diagram

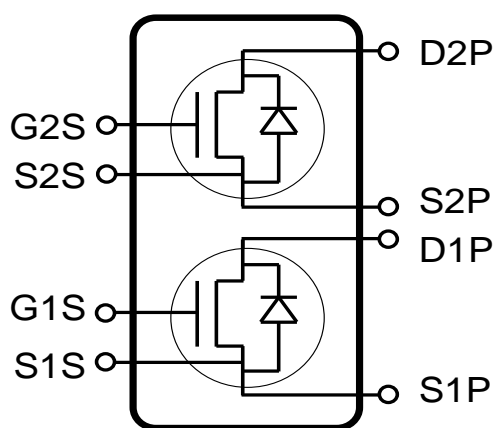

Note: the schematic shows the intrinsic body diode

Package configuration and Pin Description

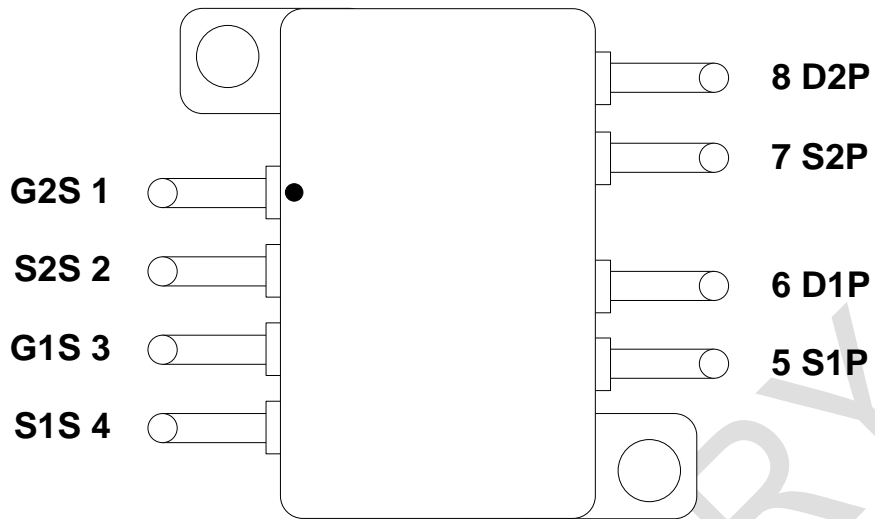

Pin ID	Pin Name	Pin Description	Pin Finish
1	G2S	Gate of MOSFET 2 (Signal Pin)	Nickel
2	S2S	Source of MOSFET 2 (Signal Pin)	Nickel
3	G1S	Gate of MOSFET 1 (Signal Pin)	Nickel
4	S1S	Source of MOSFET 1 (Signal Pin)	Nickel
5	S1P	Source of MOSFET 1 (Power Pin)	Nickel
6	D1P	Drain of MOSFET 1 (Power Pin)	Gold
7	S2P	Source of MOSFET 2 (Power Pin)	Nickel
8	D2P	Drain of MOSFET 2 (Power Pin)	Gold
	Body	Package body (isolated from Pins)	Nickel

Absolute Maximum Ratings

Gate-to-Source voltage V_{GS}	-5V to 22V
Drain-to-Source voltage V_{DS}	1200V
Max DC Drain current I_{DS}	20A
Max Junction temperature T_{jmax}	210°C
Power dissipation at $T_c=175^\circ\text{C}$ (*)	45W

Operating Conditions (per switch)

Gate-to-Source voltage V_{GS}	-5V to 20V
Drain-to-Source voltage V_{DS}	1200V
Max DC drain current I_{DS} ($T_c=175^\circ\text{C}$)	17A
Max DC drain current I_{DS} ($T_c\leq 160^\circ\text{C}$)	20A
Max pulsed drain current	25A
Junction temperature	-55°C to +210°C

ESD Rating

Human Body Model	>1kV
------------------	------

(*): per switch position and including switching losses

Electrical characteristics (per switch)

Unless otherwise stated, $T_j = 25^\circ\text{C}$. **Bold** figures point out values valid over the whole temperature range ($T_j = -55^\circ\text{C}$ to $+210^\circ\text{C}$).

Parameter	Symbol	Condition	Min	Typ	Max	Unit
Threshold voltage	V_{TH}	$T_j = 25^\circ\text{C}$; $I_D = 1\text{mA}$; $V_{DS} = 20\text{V}$		4.45		V
		$T_j = 210^\circ\text{C}$; $I_D = 1\text{mA}$; $V_{DS} = 20\text{V}$		3.28		V
Drain cut-off current	I_{DSS}	$V_{GS} = 0\text{V}$, $V_{DS} = 1200\text{V}$, $T_j = 25^\circ\text{C}$		20		nA
		$V_{GS} = 0\text{V}$, $V_{DS} = 1200\text{V}$, $T_j = 210^\circ\text{C}$		10		μA
Gate leakage current	I_{GSS}	$V_{GS} = 20\text{V}$, $V_{DS} = 1200\text{V}$, $T_j = 25^\circ\text{C}$		5		nA
		$V_{GS} = 20\text{V}$, $V_{DS} = 1200\text{V}$, $T_j = 210^\circ\text{C}$		20		nA
Static drain-to-source resistance	$R_{DS(on)}$	$V_{GS} = 20\text{V}$, $I_D = 20\text{A}$, $T_j = 25^\circ\text{C}$		40		$\text{m}\Omega$
		$V_{GS} = 20\text{V}$, $I_D = 20\text{A}$, $T_j = 210^\circ\text{C}$		120		$\text{m}\Omega$
Breakdown drain-to-source voltage (DC characterization)	V_{BRDS}	$V_{GS} = 0\text{V}$; $I_D = 1\text{mA}$	1200			V
Input capacitance	C_{ISS}	$V_{GS} = 0\text{V}_{DC}$, $V_{DS} = 600\text{V}$ $f = 1\text{MHz}$ $V_{AC} = 25\text{mV}$		1337		pF
Output capacitance (includes diode capacitance)	C_{OSS}			76		pF
Feedback capacitance	C_{RSS}			27		pF
Turn-on delay time	$T_{d(ON)}$			21		ns
Fall time	T_f	$V_{DD} = 600\text{V}$; $V_{GS} = -4/20\text{V}$ $I_D = 20\text{A}$ $RG = 6.8\Omega$; $L = 856\mu\text{H}$		39		ns
Turn-off delay time	$T_{d(OFF)}$			49		ns
Rise time	T_r			24		ns
Turn-On Switching Loss	E_{on}			240		μJ
Turn-Off Switching Loss	E_{off}			140		μJ
Internal gate resistance	R_G		$V_{GS} = 0\text{V}_{DC}$; $f = 1\text{MHz}$; $V_{AC} = 25\text{mV}$		7	
Gate to Source Charge	Q_{GS}	$T_j = 25^\circ\text{C}$; $V_{DD} = 800\text{V}$; $I_D = 20\text{A}$; $V_{GS} = -4/20\text{V}$		22		nC
Gate to Drain Charge	Q_{GD}			41		nC
Total Gate Charge	Q_G			107		nC
Diode forward voltage	V_F	$T_j = 25^\circ\text{C}$; $I_F = 20\text{A}$; $V_{GS} = -5\text{V}$		3.6		V
		$T_j = 210^\circ\text{C}$; $I_F = 20\text{A}$; $V_{GS} = -5\text{V}$		3.2		V
Reverse recovery time	T_{rr}	$T_j = 25^\circ\text{C}$; $V_{DS} = 300\text{V}$; $V_{GS} = -5\text{V}$;		220		ns
Peak reverse recovery current	I_{pr}	$I_F = 20\text{A}$; $dl_F/dt = 100\text{A}/\mu\text{S}$		2.3		A

Thermal Characteristics

Parameter	Symbol	Condition	Min	Typ	Max	Unit
Junction-to-Case Thermal resistance MOSFET	$R_{\theta JC}$			1.1		$^\circ\text{C}/\text{W}$

Typical performances (per switch)

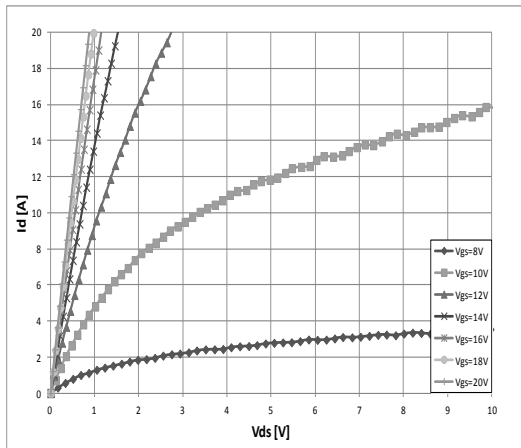

Figure 1: Drain current vs V_{DS} ($T_j= 25^\circ\text{C}$)

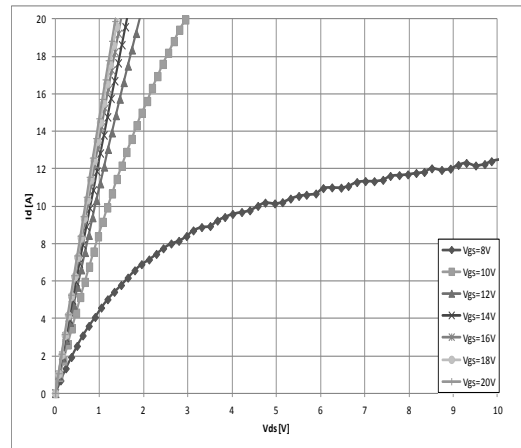

Figure 2: Drain current vs V_{DS} ($T_j= 125^\circ\text{C}$)

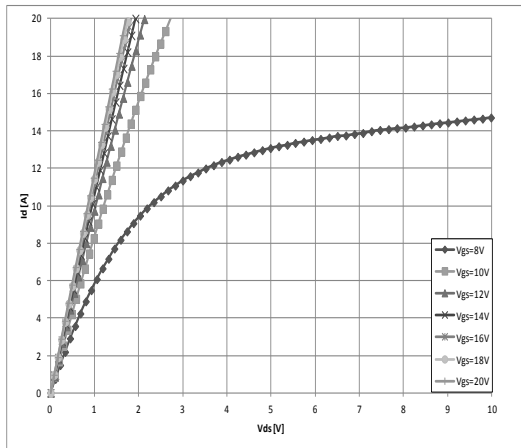

Figure 3: Drain current vs V_{DS} ($T_j= 175^\circ\text{C}$)

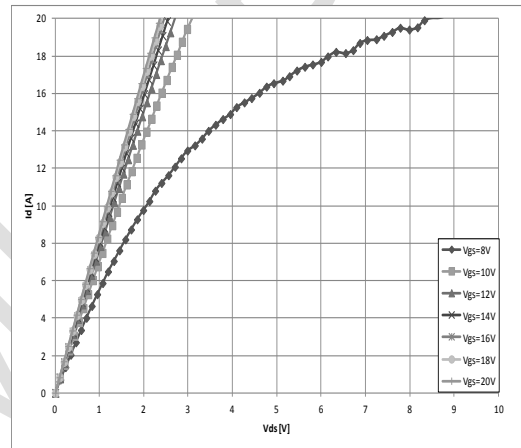

Figure 4: Drain current vs V_{DS} ($T_j= 210^\circ\text{C}$)

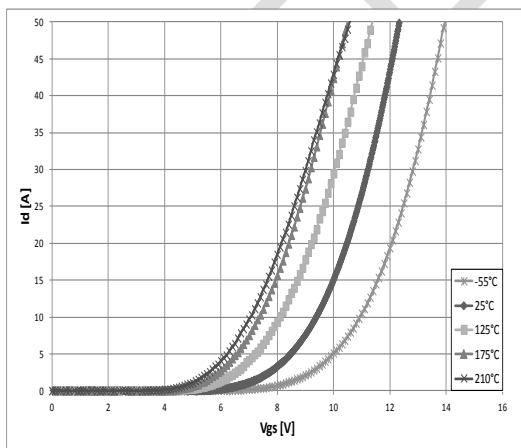

Figure 5: Drain current vs V_{GS} voltage

Typical performances (cnt'd)

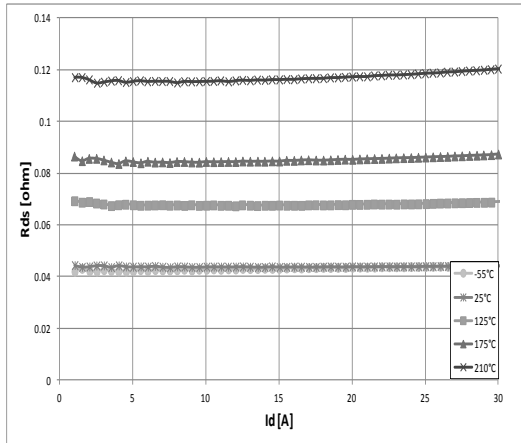

Figure 6: On-state drain source resistance vs. Drain current ($V_{GS} = 20V$)

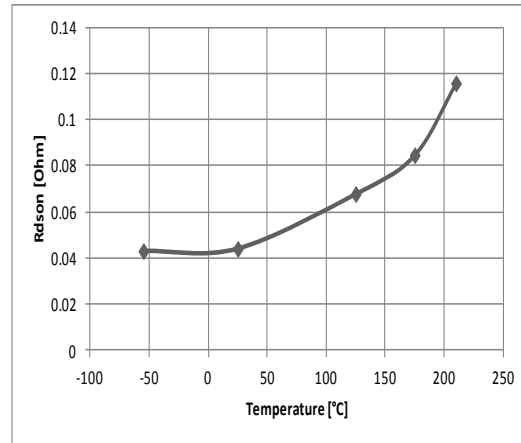

Figure 7: On-state drain source resistance vs. Temperature ($V_{GS} = 20V$; $I_{DS} = 10A$)

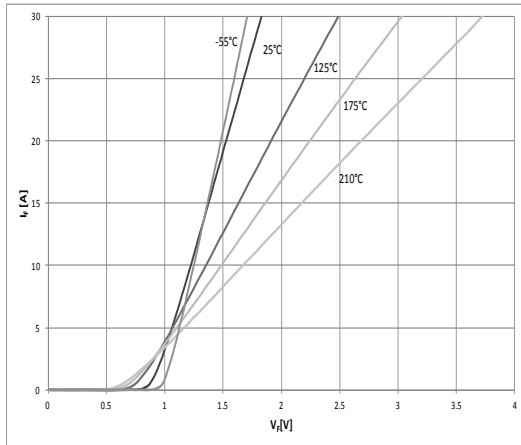
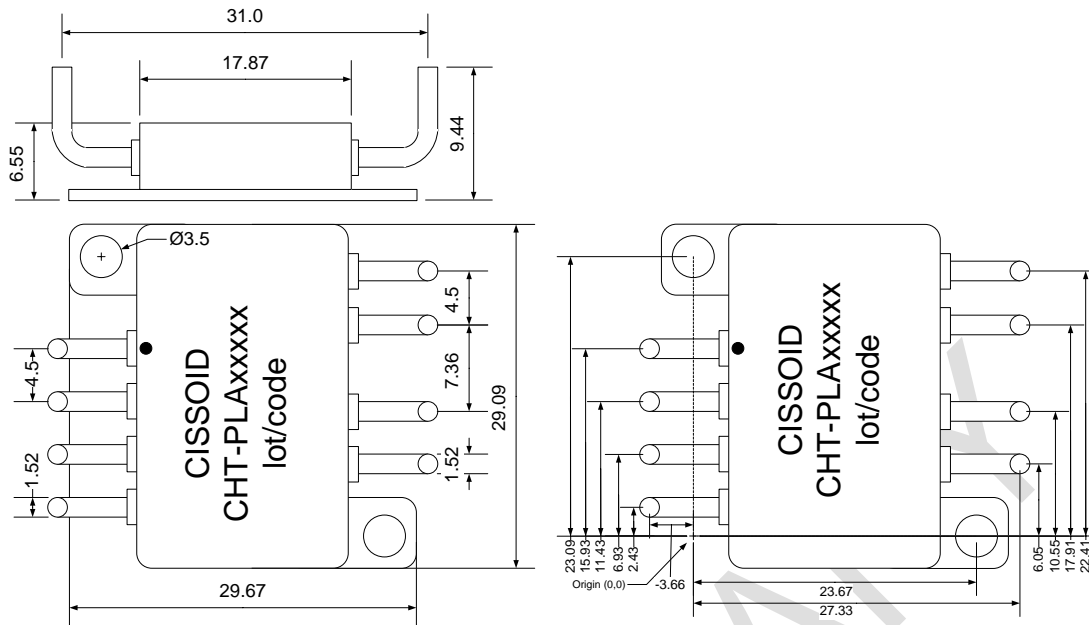

Figure 8: Diode I_{DS} vs V_{DS} (3^{rd} quadrant; $V_{GS} = -5V$)

Package Dimensions



HM8A dimensions in mm (+/- 10%)

Ordering Information

Product Name	Ordering Reference	Package	Marking
CHT-PLUTO-B1220	CHT-PLA8294A-HM8A-T	HM8A	CHT-PLA8294A

Related products

Product Name	Function	Ordering Reference
CHT-PLUTO-B1230	Dual 1200V/30A SiC MOSFET Module	CHT-PLA2316A-HM8A-T
CHT-PLUTO-C1230	1200V/30A SiC Async Buck or Boost Power Module	CHT-PLA2228A-HM8A-T
CHT-PLUTO-C1220	1200V/20A SiC Async Buck or Boost Power Module	CHT-PLA3777A-HM8A-T

Contact & Ordering

CISSOID S.A.

Headquarters and contact EMEA:	CISSOID S.A. – Rue Francqui, 3 – 1435 Mont Saint Guibert - Belgium T : +32 10 48 92 10 - F: +32 10 88 98 75 Email: sales@cissoid.com
Sales Representatives:	Visit our website: http://www.cissoid.com

Disclaimer

Neither CISSOID, nor any of its directors, employees or affiliates make any representations or extend any warranties of any kind, either express or implied, including but not limited to warranties of merchantability, fitness for a particular purpose, and the absence of latent or other defects, whether or not discoverable. In no event shall CISSOID, its directors, employees and affiliates be liable for direct, indirect, special, incidental or consequential damages of any kind arising out of the use of its circuits and their documentation, even if they have been advised of the possibility of such a damage. The circuits are provided "as is". CISSOID has no obligation to provide maintenance, support, updates, or modifications.

a damage. The circuits are provided "as is". CISSOID has no obligation to provide maintenance, support, updates, or modifications.