

## BAS521-HF

Reverse Voltage: 300 Volts

Forward Current: 250 mA

RoHS Device

Halogen Free

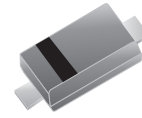

### Features

- Ultra small plastic SMD package.
- High voltage switching diode.
- High continuous reverse voltage: 300V
- Repetitive peak forward current: 625mA
- High switching speed: max.50ns, Molded plastic

### Mechanical data

- Case: SOD-523 standard package,
- Terminals: Solderable per MIL-STD-750, method 2026
- Mounting position: Any
- Weight: 0.012 grams(approx.)

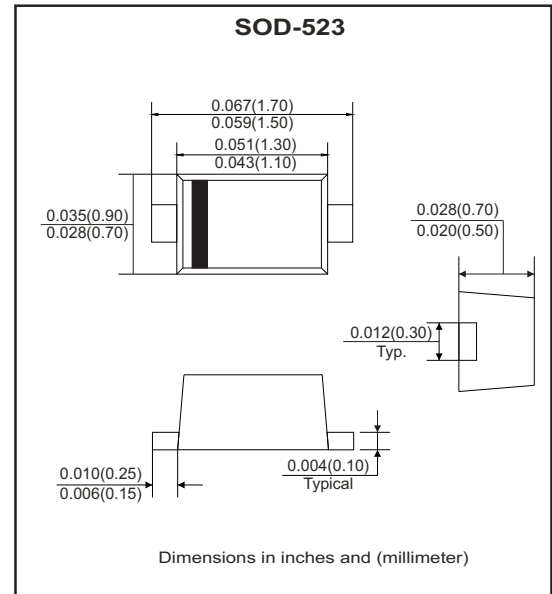

### Circuit Diagram



### Maximum Ratings (at $T_A=25^\circ\text{C}$ unless otherwise noted)

Parameter	Symbol	Value	Unit
Repetitive peak reverse voltage	$V_{RRM}$	300	V
Continuous reverse voltage	$V_R$	300	V
Continuous forward current	$I_F$	250	mA
Repetitive forward current	$I_{FRM}$	1	A
Non-repetitive peak forward surge current	$I_{FSM}$	4.5	A
Total power dissipation	$P_{tot}$	500	mW
Junction temperature	$T_J$	150	$^\circ\text{C}$
Storage and operating ambient temperature	$T_{STG}, T_{amb}$	-65 ~ +150	$^\circ\text{C}$

Note:  $T_s$  is temperature at the soldering point of the cathode tab.

### Electrical Characteristics (at $T_A=25^\circ\text{C}$ unless otherwise noted)

Parameter	Symbol	Conditions	Min.	Typ.	Max.	Unit
Breakdown voltage	$V_{BR}$	$I_R=100\mu\text{A}$	300	340		V
Forward voltage	$V_F$	$I_F=100\text{mA}$		0.95	1.1	V
Reverse current	$I_R$	$V_R=250\text{V}$		30	150	nA
	$I_R$	$V_R=250\text{V}, T_J=150^\circ\text{C}$		40	100	$\mu\text{A}$
Diode capacitance	$C_d$	$V_R=0\text{V}, f=1\text{MHz}$		0.4	5	pF
Reverse recovery time	$t_{rr}$	When switching from $I_F=30\text{mA}$ to $I_R=30\text{mA}$ ; $R_L=100\Omega$ ; measured at $I_R=3\text{mA}$		16	50	nS

## RATING AND CHARACTERISTIC CURVES (BAS521-HF)

Fig.1 - Forward current as a function of forward voltage; typical values

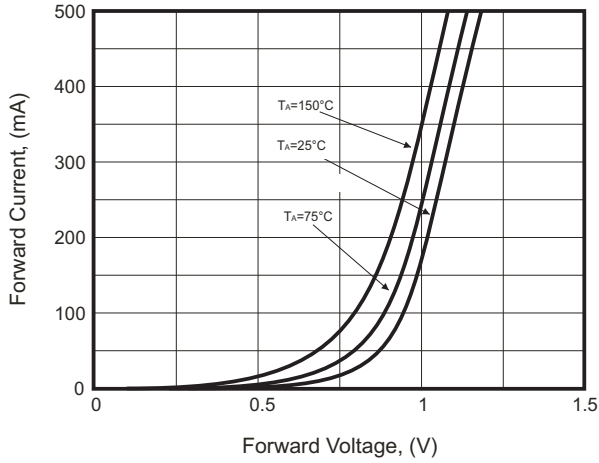

Fig.2 - Reverse current as a function of junction temperature

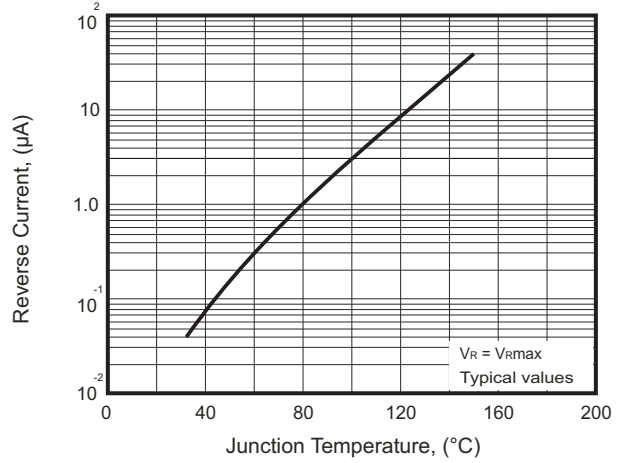

Fig.3 - Maximum permissible continuous forward current as a function of ambient temperature.

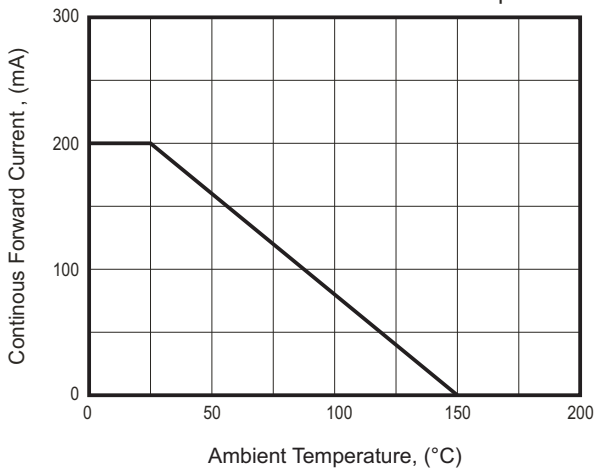

Fig.4 - Diode capacitance as a function of reverse voltage; typical values

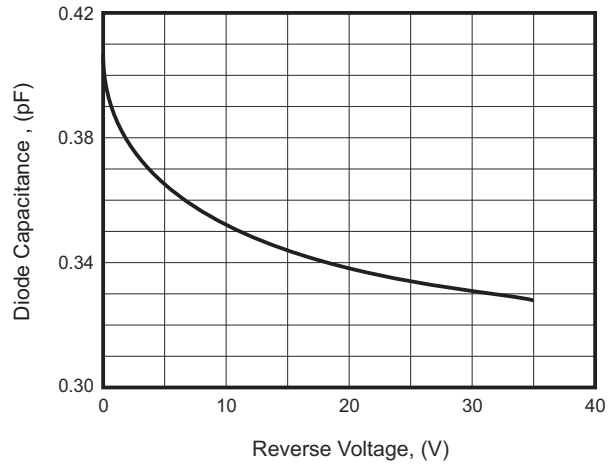
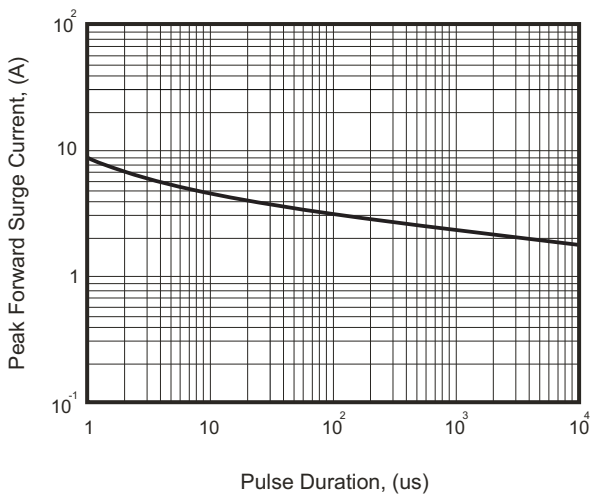
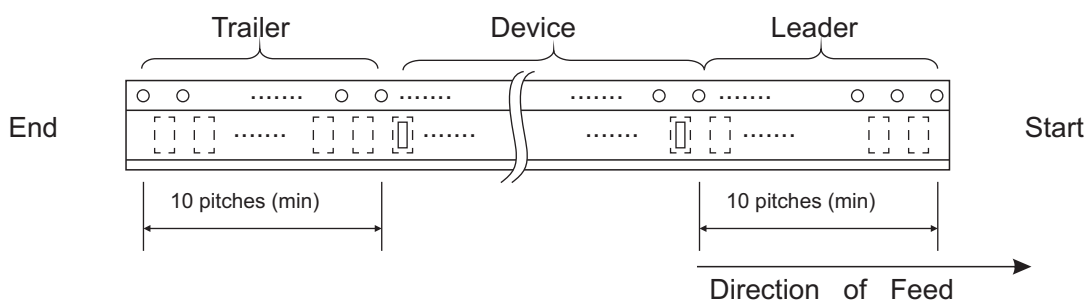
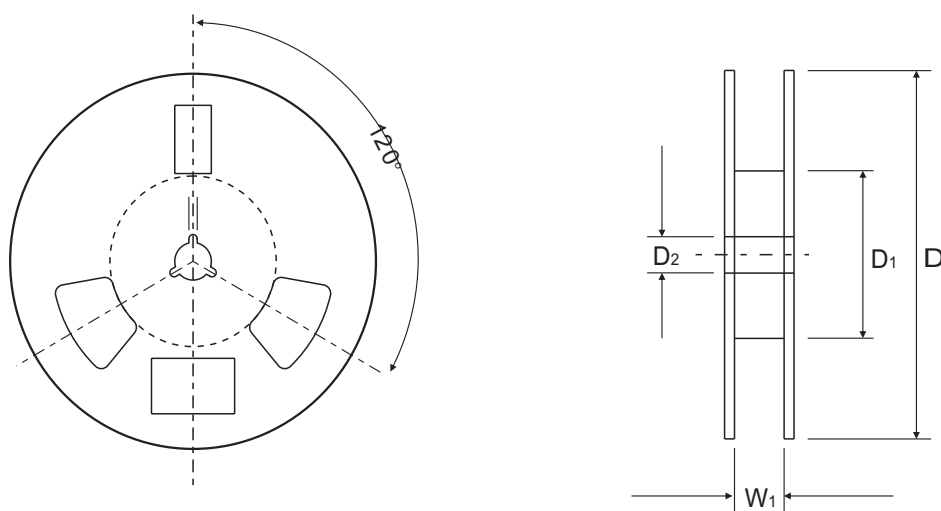
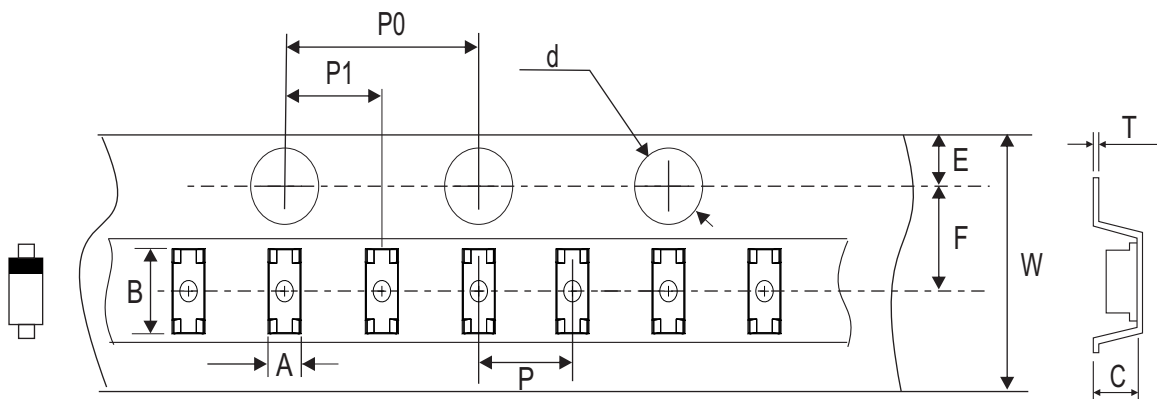

Fig.5 - Maximum permissible non-repetitive peak forward current as a Function of pulse duration



## Reel Taping Specification



SOD-523	SYMBOL	A	B	C	d	D	D1	D2
	(mm)	0.95 ± 0.05	1.94 ± 0.05	0.73 ± 0.10	1.50 ± 0.10	178 ± 1.00	54.00 ± 0.50	13.00 ± 0.50
	(inch)	0.037 ± 0.002	0.076 ± 0.002	0.029 ± 0.004	0.059 ± 0.004	7.008 ± 0.039	2.126 ± 0.020	0.512 ± 0.020

SOD-523	SYMBOL	E	F	P	P0	P1	W	W1
	(mm)	1.75 ± 0.10	3.50 ± 0.05	2.00 ± 0.05	4.00 ± 0.10	2.00 ± 0.05	8.00 + 0.30 / - 0.10	9.50 ± 1.00
	(inch)	0.069 ± 0.004	0.138 ± 0.002	0.079 ± 0.002	0.157 ± 0.004	0.079 ± 0.002	0.315 + 0.012 / - 0.004	0.374 ± 0.039

Company reserves the right to improve product design, functions and reliability without notice.

REV:A

## Marking Code

Part Number	Marking Code
BAS521-HF	L4



## Suggested PAD Layout

SIZE	SOD-523	
	(mm)	(inch)
A	1.40	0.055
B	0.40	0.016
C	0.40	0.016

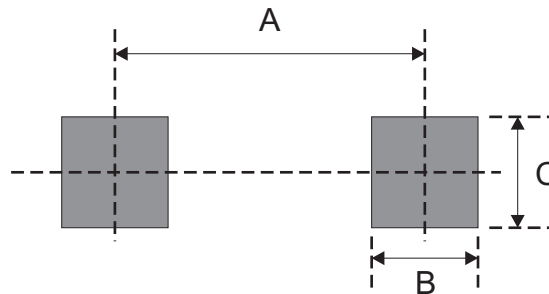

## Standard Packaging

Case Type	REEL PACK	
	REEL ( pcs )	Reel Size (inch)
SOD-523	3,000	7