

## CDSV6-4448TI/AQ/AD/CD/SD-G

**Reverse Voltage: 80 Volts**  
**Forward Current: 100 mA**  
**RoHS Device**

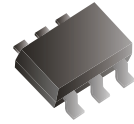

### Features

- Design for mounting on small surface.
- High speed switching.
- High mounting capability, strong surge withstand, high reliability.

### Mechanical data

- Case: SOT-363, molded plastic.
- Terminals: solderable per MIL-STD-750, method 2026.
- Approx. weight: 0.006 grams

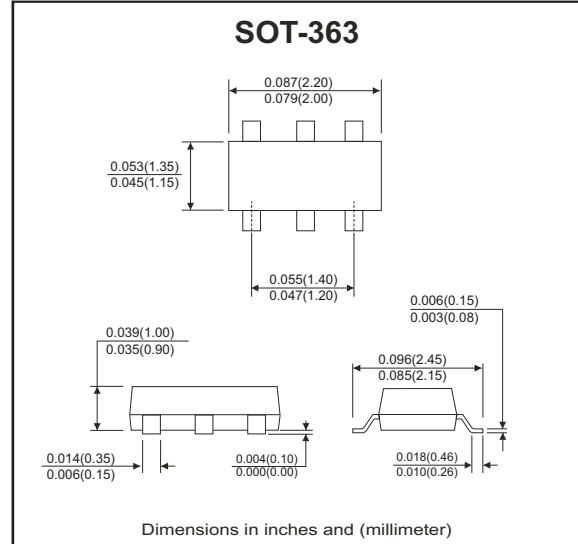

### Circuit diagram

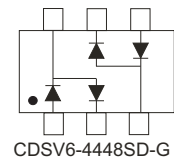
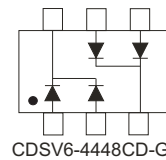
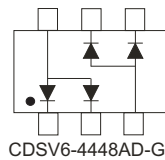
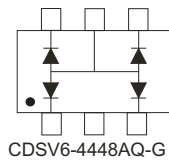
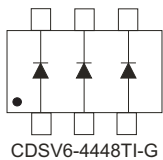

### Maximum Ratings and Electrical Characteristics

(at Ta=25°C unless otherwise noted)

Parameter	Symbol	Conditions	Value	Units
Repetitive peak reverse voltage	$V_{RRM}$		80	V
DC blocking voltage	$V_R$		80	V
Forward current	$I_F$		100	mA
Peak surge forward current	$I_{FSM}$	$T=1.0 \mu S$	2	A
Power dissipation	$P_D$		200	mW
Maximum forward voltage	$V_F$	@ $I_F=1mA$ @ $I_F=10mA$ @ $I_F=100mA$	0.72 0.855 1.0	V
Maximum reverse current	$I_R$	@ $V_R=20V$ @ $V_R=75V$ @ $V_R=25V, T_J=150 \text{ }^\circ C$ @ $V_R=75V, T_J=150 \text{ }^\circ C$	0.025 0.1 30 50	$\mu A$
Maximum reverse recovery time	$T_{rr}$	$I_F = I_R = 10mA$ $I_{rr} = 0.1 \times I_R, R_L = 100\Omega$	4	nS
Typical diode capacitance	$C_T$	$V_R=6V, f=1.0MHz$	3.5	pF
Maximum junction temperature	$T_J$		150	$^\circ C$
Storage temperature	$T_{STG}$		-55 to +150	$^\circ C$

Company reserves the right to improve product design, functions and reliability without notice.

REV:C

## RATING AND CHARACTERISTIC CURVES (CDSV6-4448TI/AQ/AD/CD/SD-G)

Fig.1 - Forward Characteristics

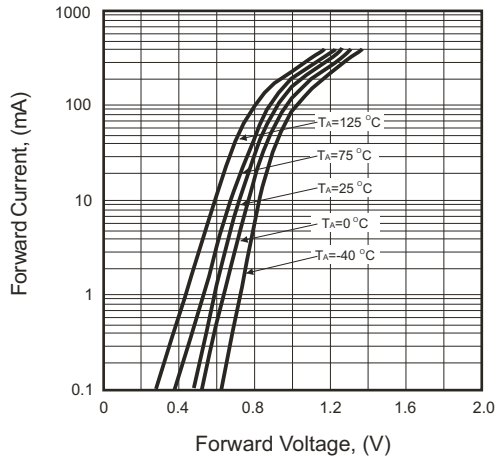

Fig.2 - Reverse Characteristics

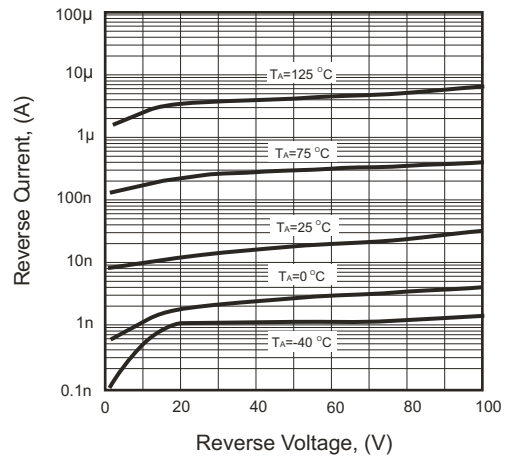

Fig.3 - Capacitance Between Terminals Characteristics

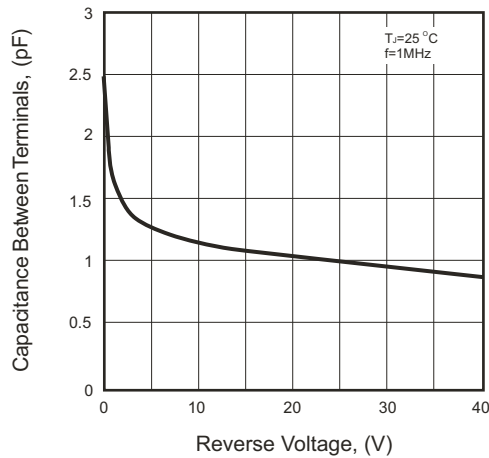
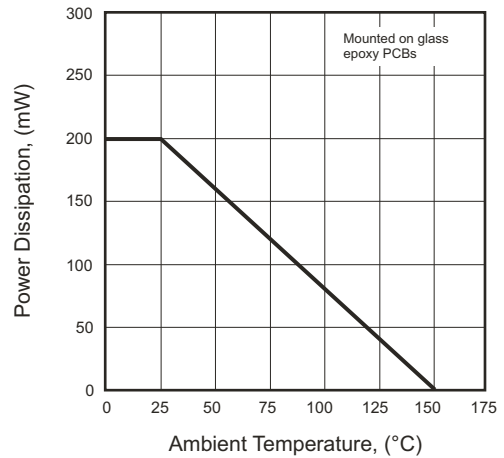
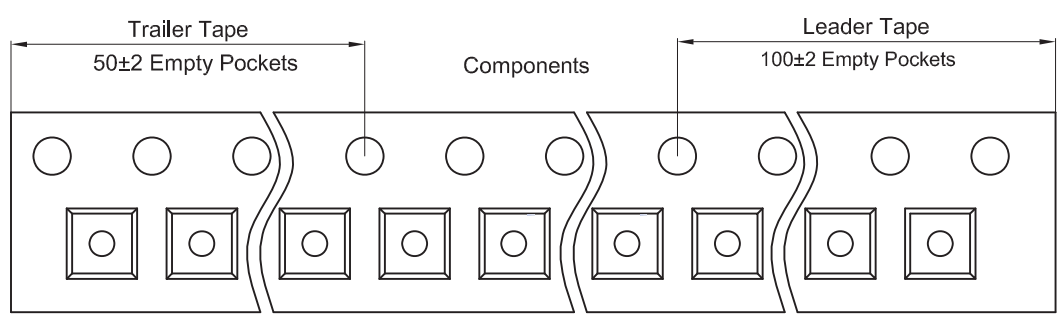
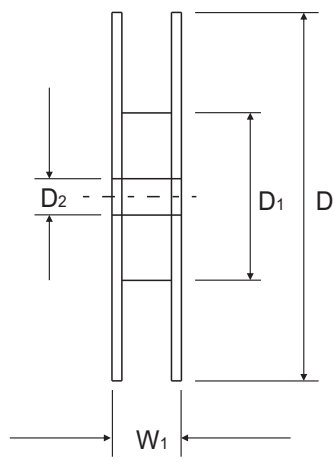
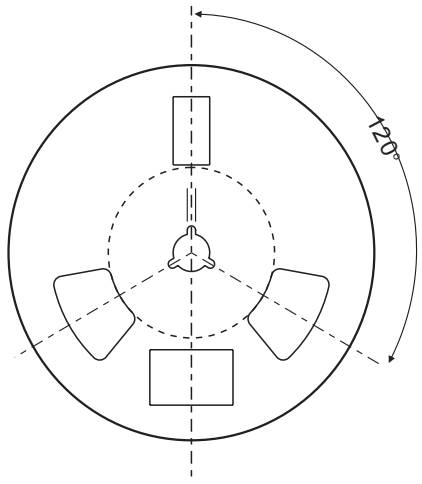
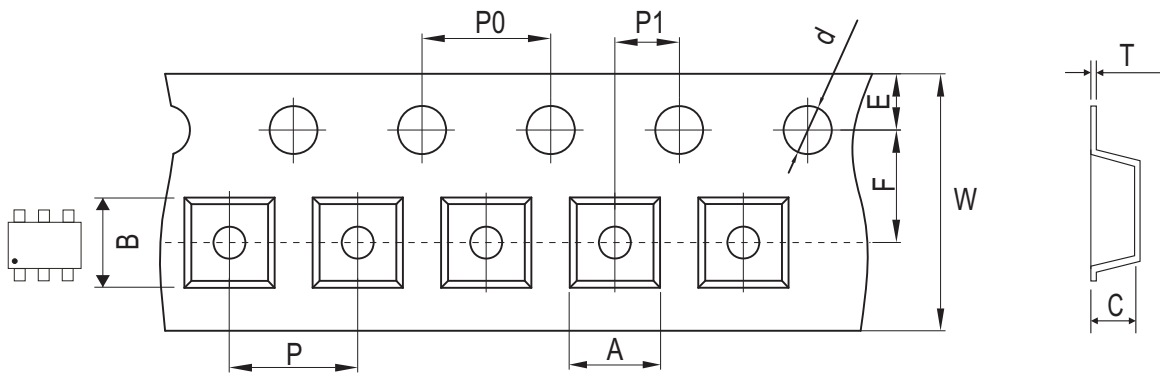

Fig.4 - Power Derating Curve



## Reel Taping Specification



SOT-363	SYMBOL	A	B	C	d	D	D1	D2
	(mm)	2.25 ± 0.05	2.55 ± 0.05	1.20 ± 0.05	1.50 ± 0.10	178 ± 2.00	54.40 ± 1.00	13.00 ± 1.00
	(inch)	0.089 ± 0.002	0.100 ± 0.002	0.047 ± 0.002	0.059 ± 0.004	7.008 ± 0.079	2.142 ± 0.039	0.512 ± 0.039

SOT-363	SYMBOL	E	F	P	P0	P1	W	W1
	(mm)	1.75 ± 0.10	3.50 ± 0.10	4.00 ± 0.10	4.00 ± 0.10	2.00 ± 0.10	8.00 + 0.30 / - 0.10	12.30 ± 1.00
	(inch)	0.069 ± 0.004	0.138 ± 0.004	0.157 ± 0.004	0.157 ± 0.004	0.079 ± 0.004	0.315 + 0.012 / - 0.004	0.484 ± 0.039

Company reserves the right to improve product design, functions and reliability without notice.

## Marking Code

Part Number	Marking Code
CDSV6-4448TI-G	KAA
CDSV6-4448AQ-G	KA5
CDSV6-4448AD-G	KA6
CDSV6-4448CD-G	KA7
CDSV6-4448SD-G	KAB

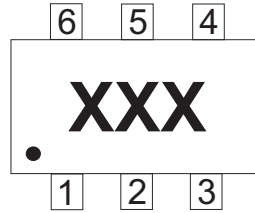

**XXX = Product type marking code**

## Suggested PAD Layout

SIZE	SOT-363	
	(mm)	(inch)
A	0.40	0.016
B	0.80	0.031
C	0.65	0.026
D	1.94	0.076

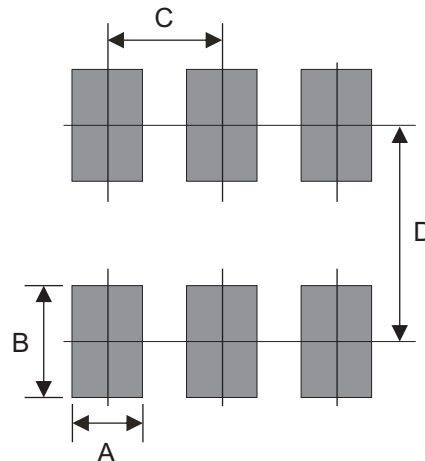

## Standard Packaging

Case Type	REEL PACK	
	REEL ( pcs )	Reel Size (inch)
SOT-363	3,000	7